

**St. Johns County School District**  
Sebastian Administrative Annex  
Purchasing Department  
3015 Lewis Speedway, Building 5  
St. Augustine, FL 32084



# INVITATION TO BID (ITB)

## REQUIRED RESPONSE FORM

BID NO.: 2020-19  
RELEASE DATE: June 15, 2020

**INVITATION TO BID TITLE: Lighting Retrofit**

F.O.B. Destination: **District Wide**

**BID DUE DATE AND TIME: July 15, 2020 @ 1:30 pm**  
**BID OPENING DATE AND TIME: July 15, 2020 @ 2:00 pm**

CONTACT: Patrick Snodgrass  
Director of Purchasing  
(904) 547-8941  
patrick.snodgrass@stjohns.k12.fl.us

SUBMIT BID TO: Sebastian Administrative Annex  
Purchasing Department  
3015 Lewis Speedway, Building 5  
St. Augustine, FL 32084

BID OPENING LOCATION: Sebastian Administrative Annex  
Purchasing Department  
3015 Lewis Speedway, Building 5  
St. Augustine, FL 32084

**REQUIRED SUBMITTALS CHECKLIST** - Each submittal checked below is **required** for Bid to be considered.

- Literature     Specifications     Catalogs     Product Samples: See Special Conditions  
 Debarment Form     Manufacturer's Certificate of Warranty  
 Drug-Free Workplace Certification     List of References  
 Certificate of Insurance: See Special Conditions  
 Additional submittals specific to this ITB may also be required – See Special Conditions for details

**BIDDER MUST FILL IN THE INFORMATION LISTED BELOW AND SIGN WHERE INDICATED FOR BID TO BE CONSIDERED.**

Company Name: \_\_\_\_\_

Address: \_\_\_\_\_

City, State: \_\_\_\_\_ Zip: \_\_\_\_\_ FEIN: \_\_\_\_\_

**Signature of Owner or Authorized Officer/Agent** \_\_\_\_\_ Telephone: \_\_\_\_\_

Typed Name of Above: \_\_\_\_\_ FAX: \_\_\_\_\_

Email: \_\_\_\_\_

By my signature, I certify that this offer is made without prior understanding, agreement, or connection with any corporation, firm, business entity or person submitting an offer for the same materials, supplies, equipment, or services (s), and is in all respects fair and without collusion or fraud. I further agree to abide by all conditions of this invitation and certify that I am authorized by the offeror to sign this response. In submitting an offer to the School Board of St. Johns County, I, as the Bidder, offer and agree that if the offer is accepted, the offeror will convey, sell, assign, or transfer to the School Board of St. Johns County all right, title, and interest in and to all causes of action it may now or hereafter acquire under the Anti-trust laws of the United States and the State of Florida for price fixing relating to the particular commodity(s) or service(s) purchased or acquired by the School Board. At the School Board's discretion, such assignment shall be made and become effective at the time the School Board of St. Johns County tenders final payment to the vendor.

## GENERAL CONDITIONS, INSTRUCTIONS AND INFORMATION

Bidder: To ensure acceptance of the bid follow these instructions:

1. **DEFINITIONS:** For purpose of these General Conditions "ITB" refers to the Invitation to Bid. "Bid" refers to the completed ITB Required Response Form above, together with all supporting documentations and submittals. "Bidder" or "Contractor" or "Respondent" or "Vendor" refers to the entity or person that submits the Bid. "District" refers to the St. Johns County School District, and "School Board" to the St. Johns County School Board. "Purchasing Department Representative" refers to the Purchasing Department staff member named as its contact on the first page of the ITB. "Conditions" refers to both the General Conditions and the Special Conditions of this ITB.
2. **EXECUTION OF BID:** The ITB Required Response Form must be completed, signed, and returned in a sealed envelope to the Purchasing Department, together with the Bid and all required submittals. All Bids must be completed in ink or typewritten. If a correction is necessary, draw a single line through the entered figure and enter the corrected figure or use an opaque correction fluid. All corrections should be initialed by the person signing the Bid even when using opaque correction fluid. Any illegible entries will not be considered for award. The ITB General Conditions, Special Conditions and specifications **cannot** be changed or altered in any way by the Bid or otherwise by the Bidder. In the event of any conflict between the Conditions and specifications of the ITB and the terms and conditions of the Bid, the Conditions and specifications of the ITB take precedence. Any failure to comply with the ITB Conditions or specifications or attempt to alter them by the Bidder shall be grounds for rejection of the Bid.
3. **SUBMISSION OF BID:** The completed Bid must be submitted in a sealed envelope with the ITB title and bid number on the outside. Bids must be time stamped by the Purchasing Department prior to the ITB due time on date due. No Bid will be considered if not time stamped by the Purchasing Department prior to the stated submission deadline. Bids submitted by telegraphic or facsimile transmission will not be accepted unless authorized by the Special Conditions of this ITB.
4. **SPECIAL CONDITIONS:** The Purchasing Department has the authority to issue Special Conditions as required for a particular ITB. Any Special Conditions that vary from these General Conditions shall take precedence over the General Conditions.
5. **PRICES QUOTED:** Deduct trade discounts and quote a firm net price. Give both unit price and aggregate total. Prices must be stated in units to quantity specified in the ITB. In case of discrepancy in computing the amount of the Bid, the **Unit Price** quoted will govern. All prices quoted shall be F.O.B. destination, freight prepaid. Bidder is responsible for freight charges. Bidder owns goods in transit and files any claims, unless otherwise stated in Special Conditions. Each item must be proposed separately and no attempt is to be made to tie any item or items in with any other item or items. If a Bidder offers a discount or offers terms less than Net 30, it is understood that a minimum of thirty (30) days will be required for payment. If a payment discount is offered, the discount time will be computed from the date of satisfactory delivery at place of acceptance and receipt of correct invoice at the office specified.
  - a) **Taxes:** The School Board does not pay Federal excise and State taxes on direct purchase of tangible personal property. The applicable tax exemption number is shown on the purchase order. This exemption does not apply to purchases of tangible personal property made by contractors who use the tangible personal property in the performance of contracts for the improvement of School Board-owned real property as defined in Chapter 192 of the Florida Statutes.
  - b) **Mistakes:** Bidders are expected to examine the General and Special Conditions, specifications, delivery schedules, Bid prices and extensions, and all instructions pertaining to supplies and services. Failure to do so will be at Bidder's risk.
  - c) **Conditions and Packaging:** It is understood and agreed that any item offered or shipped as a result of this ITB shall be new (current production model at the time of this ITB) unless otherwise stated. All containers shall be suitable for storage or shipment, and all prices shall include standard commercial packaging.
  - d) **Underwriters' Laboratories:** Unless otherwise stipulated in the ITB, all manufactured items and fabricated assemblies shall be U.L. listed where such has been established by U.L. for the item(s) offered and furnished. In lieu of the U.L. listing, Bidder may substitute a listing by an independent testing laboratory recognized by OSHA under the Nationally Recognized Testing Laboratories (NRTL) Recognition Program.
  - e) **Preference for St. Johns County Bidders:** For all purchases made by the School Board, prices and quality being equal, preference may be given to St. Johns County Bidders, subject to certification as a drug-free workplace (Florida Statutes 287.087 and 287.084).
6. **BRAND NAMES:** The District reserves the right to invite Bids for a particular product or specific equipment by manufacturer, make, model or other identifying information. However, a Bidder may propose a substitute product of equal quality and functionality unless the Conditions or specifications state that substitute products or equipment may not be proposed and will not be considered. If a substitute product is proposed, it is the Bidder's responsibility to submit

with the Bid brochures, samples and/or detailed specifications on the substitute product. The District shall be the sole judge in the exercise of its discretion for determining whether the substitute product is equal and acceptable.

7. **QUALITY:** The items proposed must be new and equal to or exceed specifications. The manufacturer's standard warranty shall apply. During the warranty period, the successful Bidder must repair and/or replace the unit without cost to the District with the understanding that all replacements shall carry the same warranty as the original equipment. The successful Bidder shall make any such repairs and/or replacements immediately upon receiving notice from the District.
8. **SAMPLES:** Samples of items, when required, must be furnished free of expense by the ITB due date unless otherwise stated. If not destroyed, upon request, samples will be returned at the Bidder's expense. Bidders will be responsible for the removal of all samples furnished within thirty (30) days after ITB opening. All samples will be disposed of after thirty (30) days. Each individual sample must be labeled with Bidder's name, ITB number, and item number. Failure of Bidder to either deliver required samples or to clearly identify samples as indicated may be reason for rejection of the ITB. Unless otherwise indicated, samples should be delivered to the office of the Purchasing Department of the St. Johns County School Board, Sebastian Administrative Annex, 3015 Lewis Speedway Building 5, St. Augustine, FL 32084.
9. **TESTING:** Items proposed may be tested for compliance with ITB Conditions and specifications.
10. **NON-CONFORMITY:** Items delivered that do not conform to ITB Conditions or specifications may be rejected and returned at Bidder's expense. Goods or services not delivered as per delivery date in ITB and/or purchase order may be purchased on the open market. The Bidder shall be responsible for any additional cost. Any violation of these stipulations may also result in Bidder being disqualified from participating in future competitive solicitations or otherwise doing business with the District.
11. **DELIVERY:** Unless actual date of delivery is specified (or if specified delivery cannot be met), the Bid must show the number of days required to make delivery after receipt of purchase order in space provided. Delivery time may become a basis for recommending an award (see Special Conditions).
12. **REQUESTS FOR CLARIFICATION:** No correction or clarification of any ambiguity, inconsistency or error in the ITB Conditions and specifications will be made to any Bidder orally. Any request for such interpretation or correction should be by email addressed to the Purchasing Department Representative prior to the deadline specified in the Special Conditions for submitting questions. All such interpretations and supplemental instructions will be in the form of written addenda to the ITB. Only the interpretation or correction so given by the Purchasing Department Representative, by email or in writing, shall be binding and prospective Bidders are advised that no other source is authorized to give information concerning, or to explain or interpret the ITB Conditions and specifications.
13. **DISPUTE:** Any dispute concerning the Conditions or specifications of this ITB or the contract resulting from this ITB shall be decided by Purchasing Department and that decision shall be final.
14. **AWARDS:** Bids shall be reviewed in accordance with the ITB Conditions and specifications and the best interest of the School District. To that end, the Board reserves the right to reject any and all Bids; to waive any irregularities or informalities; to accept any item or group of items; to request additional information or clarification from any Bid; to acquire additional quantities at prices quoted in the Bid unless additional quantities are not acceptable, in which case the Bid must be conspicuously labelled "BID IS FOR SPECIFIED QUANTITY ONLY", and to purchase the product or service at the price and terms of any contract with a governmental entity procured by competitive solicitation, in accordance with Florida law. The decision to award a contract or take other action in regard to the ITB shall be made in the best interest of the School District.
15. **OTHER GOVERNMENTAL AGENCIES:** Successful bidder(s) may permit any school board, community college, state university, municipality, or other governmental entity, to include public charter schools, to purchase goods or services based on the contract awarded as a result of this ITB. Such purchases shall be governed by the same terms and conditions as stated herein.
16. **MARKING:** A packing list must be included in each shipment and shall show the School Board purchase order number, ITB number, school name or department name, contents and shipper's name and address; mark packing list and invoice covering final shipment "Order Completed". If no packing list accompanies the shipment, the buyer's count will be accepted. Mark each package clearly with (A) shipper's name and address, (B) contents, (C) the School Board of St. Johns County purchase order number, and (D) ITB number.
17. **INSPECTION, ACCEPTANCE & TITLE:** Inspection and acceptance will be at destination shown on purchase order unless otherwise provided. Title to/or risk of loss or damage to all items shall be the responsibility of the successful Bidder until acceptance by the District. If the materials or services supplied to the District are found to be defective or do not conform to specifications, the Board reserves the right to cancel the order upon written notice to the Bidder and return product at Bidder's expense.
18. **BILLING AND PAYMENT:** Invoices, unless otherwise indicated, must show purchase order numbers and shall be submitted to St. Johns County School District, Accounts Payable Department, 40 Orange Street, St. Augustine, FL 32084. Payment will be made as prescribed in the Special Conditions and properly invoiced.

19. **COPYRIGHT AND PATENT RIGHTS:** The Bidder, without exception, shall indemnify and hold harmless the School Board and its employees from liability of any nature or kind, including legal fees and other costs and expenses, for or on account of any copyrighted, patented, or unpatented invention, process, or article manufactured or used in the performance of the contract, including its use by the School Board. If the Bidder uses any design, device, or materials covered by letters, patent, or copyright, it is mutually understood and agreed without exception that the Bid prices shall include all royalties or cost arising from the use of such design, device or materials in any way involved in the work.
20. **OSHA:** The Bidder warrants that the product supplied to the School Board shall conform in all respects to the standards set forth in the Occupational Safety and Health Act of 1970, as amended, and the failure to comply with this condition will constitute a breach of contract.
21. **LEGAL REQUIREMENTS:** The Bidder shall comply with Federal, State, County, and local laws, ordinances, rules, and regulations that in any manner affect the items covered herein. Lack of knowledge by the Bidder will in no way be a cause for relief from responsibility.
22. **CONFLICT OF INTEREST:** The award hereunder is subject to the provisions of Chapter 112, Florida Statutes. All Bidders must disclose with their Bid the name of any officer, director, or agent who is also an employee of the School Board. Further, all Bidders must disclose the name of any Board employee who owns directly or indirectly, an interest of five percent (5%) or more of the total assets of capital stock in the Bidder's firm.
23. **ANTI-DISCRIMINATION:** The Bidder certifies that Bidder is in compliance with the requirements of law regarding equal employment opportunity for all persons without regard to age, race, color, religion, sex, national origin, or disability.
24. **LICENSES AND PERMITS:** The Bidder shall be responsible for obtaining, at its expense, all licenses and permits required for performance of the work or services resulting from the ITB award.
25. **BID BONDS, PERFORMANCE BONDS, CERTIFICATES OF INSURANCE:** Bid bonds, when required, shall be submitted with the Bid in the amount specified in Special Conditions. Bid bonds will be returned to unsuccessful Bidders. After acceptance of Bid, the Board will notify the successful Bidder to submit a performance bond and certificate of insurance in the amount specified in Special Conditions. St. Johns County School District shall be named as additional insured on policies required by detailed specifications. Upon receipt of the performance bond, the Bid bond will be returned to the successful Bidder.
26. **DEFAULT AND REMEDIES:** The following remedies for default shall apply.
  - a) **Failure to Timely Deliver.** The parties acknowledge and agree that the damages for the failure of the successful Bidder to timely deliver the products or services contracted for may be difficult to determine. Moreover, both parties wish to avoid lengthy delay and expensive litigation relating to the failure of the successful Bidder to deliver on time. Therefore, in the event the successful Bidder fails to timely deliver the products or services contracted for, the School Board may exercise the remedy of liquidated damages against the successful Bidder in an amount equal to 25% of the unit price Bid, times the quantity. The successful Bidder shall pay that sum to the School Board not as a penalty, but as liquidated damages intended to compensate for unknown and unascertainable damages.
  - b) **Other Default.** In the event of default for any reason other than the failure of the successful Bidder to timely deliver the products or services contracted for, the School Board may exercise any and all remedies in contract or tort available to it, including, but not limited to, the recovery of actual and consequential damages.
27. **TERMINATION:** In the event any of the provisions of this ITB are violated by the Bidder, the Purchasing Department reserves the right to reject its Bid. Furthermore, the School Board reserves the right to terminate any contract resulting from this ITB for financial or administrative convenience, as determined in its sole business judgment, upon giving thirty (30) days prior written notice to the other party.
28. **FACILITIES:** The Board reserves the right to inspect the Bidder's facilities at any time with prior notice.
29. **ASBESTOS STATEMENT:** All material supplied to the School Board must be 100% asbestos free. Bidder by virtue of proposing, certifies by signing Bid, that if awarded any portion of this Bid, will supply only material or equipment that is 100% asbestos free.
30. **INDEMNITY AND HOLD HARMLESS AGREEMENT:** During the term of this Bid and any contract awarded to Bidder as a result of this ITB, the Bidder shall indemnify, hold harmless, and defend the School Board, its agents, and employees from any and all costs and expenses, including but not limited to, attorney's fees, reasonable investigative and recovery costs, court costs and all other sums which the Board, its agents, servants and employees, may pay or become obligated to pay on account of any, all and every claim or demand, or assertion of liability, or any claim or actions founded, thereon, arising or alleged to have arisen out of the products, goods or services furnished by the Bidder, its agents, or employees, or any of its equipment, including, without limitation, claims for damages, injury to person or property, including the Board's property, or death.
31. **CRIMINAL BACKGROUND SCREENING:** Pursuant to Florida Statute 1012.467 and School Board Rule 7.142, the District will issue and recognize statewide background badges to non-instructional contractor employees who meet the clearance requirements of Florida Statute 1012.467(2)(g) when it is not anticipated that they will come into direct contact with students. However, pursuant to Florida Statute 1012.467 and School Board Rule 7.142, if the District is unable to

rule out that Bidder's employees or subcontractors may come into contact with students, then, in the paramount interest of student safety, the employees will be required to undergo and pass background screening in accordance with School Board Rule 7.142, unless another statutory exemption applies.

**For this ITB:**

- A.  Student contact not anticipated
- B.  Student contact anticipated

If Box A is checked, statewide badge will be recognized or issued, if requested and the contractor meets clearance requirements.

If Box B is checked, background screening pursuant to School Board Rule 7.142(4) will be required.

**The Bidder acknowledges and agrees to comply with the requirements of School Board Rule 7.142. Bidder shall be responsible for the expense of the background screening of its employees.**

- 32. **VENUE:** Any suit, action, or other legal proceedings arising out of or relating to any contract awarded based upon this ITB shall be brought in a court of competent jurisdiction in St. Johns County, Florida. The parties waive any right to require that a suit, action, or proceeding arising out of this Agreement be brought in any other jurisdiction or venue.
- 33. **WAIVER OF JURY TRIAL:** The parties knowingly, voluntarily, and intentionally waive their right to trial by jury with respect to any litigation arising out of, under, or in connection with this ITB or any contract awarded upon this ITB. This provision is a material inducement for the School Board to enter into a contract with the successful Bidder.
- 34. **LOBBYING:** Lobbying is not permitted with any District personnel or School Board members in connection with any ITB or competitive solicitation. All oral or written inquiries must be directed through the Purchasing Department. Lobbying is defined as any action taken by an individual, firm, association, joint venture, partnership, syndicate, corporation, and all other groups who seek to influence the governmental decision of a board member or district personnel on the award of this contract. Any Bidder or any individuals that lobby on behalf of Bidder will result in rejection/disqualification of said Bid.
- 35. **ASSIGNMENTS:** The successful bidder may not sell, assign or transfer any of its rights, duties or obligations under Bid contract without the prior written consent of the School Board.
- 36. **PROTEST:** Failure to give notice or file a protest within the time prescribed in Section 120.57 (3), Florida Statutes, shall constitute a waiver of any protest.
- 37. **COMPLIANCE WITH FEDERAL REGULATIONS:** All contracts involving Federal funds will contain certain provisions required by applicable sections of Title 34, Section 80.36(l) and 85.510, Code of Federal Regulations and are included by reference herein.
- 38. **PUBLIC ENTITY CRIME:** Pursuant to Florida Statute 287.133, a person or affiliate who has been placed on the convicted vendor list following a conviction for a public entity crime may not submit a Bid on a contract to provide any goods or services to a public entity, may not submit a Bid on a contract with a public entity for the construction or repair of a public building or public work, may not submit Bids on leases of real property to a public entity, may not be awarded or perform work as a contractor, supplier, subcontractor, or consultant under a contract with any public entity, and may not transact business with any public entity in excess of the threshold amount provided in Section 287.017 of Florida Statute, for CATEGORY TWO for a period of thirty-six (36) months from the date of being placed on the convicted vendor list.
- 39. **COLLECTION, USE OR RELEASE OF SOCIAL SECURITY NUMBERS:** The St. Johns County School District is authorized to collect, use or release social security numbers (SSN) of vendors, contractors and their employees and for the following purposes, which are noted as either required or authorized by law to be collected. The collection of social security numbers is either specifically authorized by law or imperative for the performance of the District's duties and responsibilities as prescribed by law (Sections 119.07(5)(a)2 and 3, Florida Statutes):
  - a) **Criminal history and criminal background checks/Identifiers for processing fingerprints by Department of Law Enforcement/, if SSN is available** [Required by Fla. Admin. Code 11 C-6.003 and Fla. Stat. § 119.07(5)(a)6]
  - b) **Vendors/Consultants that District reasonably believes would receive a 1099 form if a tax identification number is not provided including for IRS form W-9** [Required by 26 C.F.R. § 31.3406-0, 26 C.F.R. § 301.6109-1, and Fla. Stat. § 119.07(5)(a)2 and 6]
- 40. **PURCHASING AGREEMENTS AND STATE TERM CONTRACTS:** The Purchasing agreements and state term contracts available under s. 287.056 have been reviewed.
- 41. **DISCRIMINATORY VENDOR LIST:** Pursuant to Florida Statute 287.134, an entity or affiliate who has been placed on the discriminatory vendor list may not submit a bid, proposal, or reply on a contract to provide any goods or services to a public entity; may not submit a bid, proposal, or reply on a contract with a public entity for the construction or repair of a public building or public work; may not submit bids, proposals, or replies on leases of real property to a public entity;

may not be awarded or perform work as a contractor, supplier, subcontractor, or consultant under a contract with any public entity; and may not transact business with any public entity.

- 42. PROHIBITION AGAINST CONTRACTING WITH SCRUTINIZED COMPANIES:** Pursuant to Florida Statute 287.135, a company is ineligible to, and may not, bid on, submit a proposal for, or enter into or renew a contract with an agency or local government entity for goods or services of any amount if, at the time of bidding on, submitting a proposal for, or entering into or renewing such contract, the company is on the Scrutinized Companies that Boycott Israel List created pursuant to s. 215.4725 or is engaged in a boycott of Israel; or for \$1 million or more if, at the time of bidding on, submitting a proposal for, or entering into or renewing a contract, is on the Scrutinized Companies with Activities in Sudan List or the Scrutinized Companies with Activities in the Iran Petroleum Energy Sector List created pursuant to 215.473 or is engaged in business operations in Cuba or Syria.

The company/vendor certifies by submission and signature of this bid that: it is not on the Scrutinized Companies with Activities in Sudan List; the Scrutinized Companies with Activities in the Iran Petroleum Energy Sector List; the Scrutinized Companies that Boycott Israel list, engaged in a boycott of Israel or that it is not engaged in business operations in Cuba or Syria. Any contract for goods or services of any amount may be terminated at the option of the awarding body if the company is found to have been placed on the Scrutinized Companies that Boycott Israel List or is engaged in a boycott of Israel. A contract for goods and services of \$1 million or more may be terminated at the option of the awarding body if the company is found to have submitted false certification, has been placed on any of the other lists in this section or has been engaged in business operations in Cuba or Syria.

- 43. PUBLIC RECORDS AND CONFIDENTIALITY:** Subject to the limited confidentiality afforded pending competitive solicitation by Florida Statute 119.071, the ITB and all Bids are public records subject to disclosure pursuant to the Florida Public Records Law. Requests for tabulations and other records pertinent to the competitive solicitation shall be processed in accordance with the Florida Public Records Law. By submitting a Bid, Bidders will be deemed to have waived any claim of confidentiality based on trade secrets, proprietary rights, or otherwise.

Florida Statute 119.0701 requires the Contractor to comply with Florida's public records laws with respect to services performed on behalf of the School District. Specifically, the Statute requires that the Contractor:

- a) Keep and maintain public records required by the School District to perform the service.
- b) Upon request from the School District's custodian of public records, provide the School District with a copy of the requested records or allow the records to be inspected or copied within a reasonable time at a cost that does not exceed the cost provided in Chapter 119 of the Florida Statutes or as otherwise provided by law.
- c) Ensure that public records that are exempt or confidential and exempt from public records disclosure requirements are not disclosed except as authorized by law for the duration of the contract term and following completion of the contract if the Contractor does not transfer the records to the School District.
- d) Upon completion of the contract, transfer, at no cost, to the School District all public records in possession of the Contractor or keep and maintain public records required by the School District to perform the service. If the Contractor transfers all public records to the School District upon completion of the contract, the contractor shall destroy any duplicate public records that are exempt or confidential and exempt from public records disclosure requirements. If the contractor keeps and maintains public records upon completion of the contract, the contractor shall meet all applicable requirements for retaining public records. All records stored electronically must be provided to the School District, upon request from the School District's custodian of public records, in a format that is compatible with the information technology systems of the School District.

**IF THE CONTRACTOR HAS QUESTIONS REGARDING THE APPLICATION OF CHAPTER 119, FLORIDA STATUTES, TO THE CONTRACTOR'S DUTY TO PROVIDE PUBLIC RECORDS RELATING TO THIS CONTRACT, CONTACT THE CUSTODIAN OF PUBLIC RECORDS AT 904-547-7637; [sjpubrec@stjohns.k12.fl.us](mailto:sjpubrec@stjohns.k12.fl.us) ; OR ST. JOHNS COUNTY SCHOOL BOARD, ATTN: COMMUNITY RELATIONS, 40 ORANGE STREET, ST. AUGUSTINE, FL 32084**

# Certification Regarding Debarment, Suspension, Ineligibility and Voluntary Exclusion - Lower Tier Covered Transactions

*This certification is required by the Department of Education regulations implementing Executive Order 12549, Debarment and Suspension, 34 CFR Part 85, for all lower tier transactions meeting the threshold and tier requirements stated at Section 85.110.*

1. By signing and submitting this proposal, the prospective lower tier participant is providing the certification set out below.
2. The certification in this clause is a material representation of fact upon which reliance was placed when this transaction was entered into. If it is later determined that the prospective lower tier participant knowingly rendered an erroneous certification, in addition to other remedies available to the Federal Government, the department or agency with which this transaction originated may pursue available remedies, including suspension and/or debarment.
3. The prospective lower tier participant shall provide immediate written notice to the person to whom this proposal is submitted if at any time the prospective lower tier participant learns that its certification was erroneous when submitted or has become erroneous by reason of changed circumstances.
4. The terms "covered transaction," "debarred," "suspended," "ineligible," "lower tier covered transaction," "participant," "person," "primary covered transaction," "principal," "proposal," and "voluntarily excluded," as used in this clause, have the meanings set out in the Definitions and Coverage sections of rules implementing Executive Order 12549. You may contact the person to which this proposal is submitted for assistance in obtaining a copy of those regulations.
5. The prospective lower tier participant agrees by submitting this proposal that, should the proposed covered transaction be entered into, it shall not knowingly enter into any lower tier covered transaction with a person who is debarred, suspended, declared ineligible, or voluntarily excluded from participation in this covered transaction, unless authorized by the department or agency with which this transaction originated.

6. The prospective lower tier participant further agrees by submitting this proposal that it will include the clause titled "Certification Regarding Debarment, Suspension, Ineligibility, and Voluntary Exclusion - Lower Tier Covered Transactions," without modification, in all lower tier covered transactions and in all solicitations for lower tier covered transactions.
7. A participant in a covered transaction may rely upon a certification of a prospective participant in a lower tier covered transaction that it is not debarred, suspended, ineligible, or voluntarily excluded from the covered transaction, unless it knows that the certification is erroneous. A participant may decide the method and frequency by which it determines the eligibility of its principals. Each participant may, but is not required to, check the Nonprocurement List.
8. Nothing contained in the foregoing shall be construed to require establishment of a system of records in order to render in good faith the certification required by this clause. The knowledge and information of a participant is not required to exceed that which is normally possessed by a prudent person in the ordinary course of business dealings.
9. Except for transactions authorized under paragraph 5 of these instructions, if a participant in a covered transaction knowingly enters into a lower tier covered transaction with a person who is suspended, debarred, ineligible, or voluntarily excluded from participation in this transaction, in addition to other remedies available to the Federal Government, the department or agency with which this transaction originated may pursue available remedies, including suspension and/or debarment.

## Instructions for Certification:

1. The prospective lower tier participant certifies, by submission of this proposal that neither it nor its principals are:
  - (a) presently debarred, suspended, proposed for debarment, declared ineligible, or voluntarily excluded from participation in this transaction by any Federal department or agency;
  - (b) have not within a three-year period preceding this application been convicted of or had a civil judgment rendered against them for commission of fraud or a criminal offense in performing a public (federal, state or local) transaction or contract under a public transaction; or for violation of federal or state antitrust statutes or commission of embezzlement, theft, forgery, bribery, falsification or destruction of records, making false statements or receiving stolen property;
  - (c) are not presently indicted for or otherwise criminally or civilly charged by a government entity (federal, state or local) with commission of the offenses enumerated in this certification; or
  - (d) have not within a three-year period preceding this application had one or more public transaction (federal, state or local) terminated for cause or default.
2. Where the prospective lower tier participant is unable to certify to any of the statements in this certification, such prospective participant shall attach an explanation to this proposal.

Name of Applicant	PR/Award Number and/or Project Name
Printed Name	Title of Authorized Representative
Signature	Date

## DRUG FREE WORKPLACE CERTIFICATION FORM

In accordance with 287.087, Florida Statutes, preference shall be given to businesses with drug-free workplace programs. Whenever two or more bids, which are equal with respect to price, quality, and service, are received by the state or by any political subdivision for the procurement of commodities or contractual services, a bid received from a business that certifies that it has implemented a drug-free workplace program *shall be given preference* in the award process. Established procedures for processing tie bids will be followed if none of the tied vendors have a drug-free workplace program. In order to have a drug-free program, a business shall:

- 1) Publish a statement notifying employees that the unlawful manufacture, distribution, dispensing, possession, or use of a controlled substance is prohibited in the workplace and specifying the action that will be taken against employees for violations of such prohibition.
- 2) Inform employees about the dangers of drug abuse in the workplace, the business's policy of maintaining a drug-free workplace, any available drug counseling, rehabilitation, and employee assistance programs, and the penalties that may be imposed upon employees for drug abuse violations.
- 3) Give each employee engaged in providing the commodities or contractual services that are under bid a copy of the statement specified in subsection (1).
- 4) In the statement specified in subsection (1), notify the employees that, as a condition of working on the commodities or contractual services that are under bid, the employee will abide by the terms of the statement and will notify the employer of any conviction of, or plea of guilty or nolo contendere to, any violation of chapter 893 or of any controlled substance law of the United States or any state, for a violation occurring in the workplace no later than five (5) days after such conviction.
- 5) Impose a sanction on, or require the satisfactory participation in a drug abuse assistance or rehabilitation program if such is available in the employee's community, by any employee who is so convicted.
- 6) Make a good faith effort to continue to maintain a drug-free workplace through implementation of this section.

As the person authorized to sign the statement, I certify that this firm complies fully with the above requirements.

---

(Vendor's Signature)





**BIDDER’S STATEMENT OF PRINCIPAL PLACE OF BUSINESS**

(Must be completed & submitted with each competitive solicitation)

Bid number and description: \_\_\_\_\_

Identify the state in which the Vendor has its principal place of business: \_\_\_\_\_

**Instructions: IF your principal place of business above is located within the State of Florida, the Vendor must sign below and submit this form with your bid response, no further action is required.**

**However, if your principal place of business is outside of the State of Florida, the following must be completed by an attorney and returned with your bid response. FAILURE TO COMPLY SHALL BE CONSIDERED TO BE NON-RESPONSIVE TO THE TERMS OF THE SOLICITATION.**

**OPINION OF OUT –OF-STATE BIDDER’S ATTORNEY ON BIDDING PREFERENCES**

(To be completed by the Attorney for an Out-of-State Vendor)

**NOTICE:** Section 287.084(2), Florida Statute, provides that “a vendor whose principal place of business is outside this state must accompany any written bid, proposal, or reply documents with a written opinion of an attorney at law licensed to practice law in that foreign state, as to the preferences, if any or none, granted by the law of that state (or political subdivision thereof) to its own business entities whose principal places of business are in that foreign state in the letting of any or all public contracts.” See also: Section 287.084(1), Florida Statutes.

**LEGAL OPINION ABOUT STATE BIDDING PREFERENCES**

(Please Select One)

\_\_\_\_\_ The Vendor’s principal place of business is in the State of \_\_\_\_\_ and it is my legal opinion that the laws of that state **do not grant a preference** in the letting of any or all public contracts to business entities whose principal places of business are in that state.

\_\_\_\_\_ The Vendor’s principal place of business is in the State of \_\_\_\_\_ and it is my legal opinion that the laws of that state **grant the following preference(s)** in the letting of any or all public contracts to business entities whose principal places of business are in that state: (Please describe applicable preference(s) and identify applicable preference(s) and identify applicable state law(s)):

\_\_\_\_\_  
\_\_\_\_\_

**LEGAL OPINION ABOUT POLITICAL SUBDIVISION BIDDING PREFERENCES**

(Please Select One)

\_\_\_\_\_ The Vendor’s principal place of business is in the political subdivision of \_\_\_\_\_ and it is my legal opinion that the laws of that political subdivision **do not grant a preference** in the letting of any or all public contracts to business entities whose principal places of business are in that political subdivision.

\_\_\_\_\_ The Vendor’s principal place of business is in the political subdivision of \_\_\_\_\_ and the laws of that political subdivision **grant the following preference(s)** in the letting of any or all public contracts to business entities whose principal places of business are in that political subdivision: (Please describe applicable preference(s) and identify applicable authority granting the preference(s)):

\_\_\_\_\_  
\_\_\_\_\_

Signature of out-of-state Vendor’s attorney: \_\_\_\_\_

Attorney’s printed name: \_\_\_\_\_

Address of out-of-state Vendor’s attorney: \_\_\_\_\_

Phone number/e-mail of out-of-state Vendor’s attorney: \_\_\_\_\_

Attorney’s states of bar admission: \_\_\_\_\_

Vendor’s Signature: \_\_\_\_\_

Vendor’s Printed Name: \_\_\_\_\_

## **EDGAR CERTIFICATIONS**

All purchases involving the expenditure of federal funds must be compliant with the Education Department General Administrative Guidelines ("EDGAR"). The following certifications and provisions are required and apply when the St. Johns County School Board ("School Board") expends federal funds for any purchase resulting from this procurement process. Pursuant to 2 C.F.R. § 200.326, all contracts, including small purchases, awarded by the District shall contain the procurement provisions of Appendix II to Part 200, as applicable.

---

### **REQUIRED CONTRACT PROVISIONS FOR NON-FEDERAL ENTITY CONTRACTS UNDER FEDERAL AWARDS APPENDIX II to C.F.R. PART 200**

---

**(A) Contracts for more than the simplified acquisition threshold currently set at \$150,000, which is the inflation adjusted amount determined by the Civilian Agency Acquisition Council and the Defense Acquisition Regulations Council (Councils) as authorized by 41 U.S.C. 1908, must address administrative, contractual, or legal remedies in instances where contractors violate or breach contract terms, and provide for such sanctions and penalties as appropriate.**

Pursuant to Federal Rule (A) above, when School Board expends federal funds, School Board reserves all rights and privileges under the applicable laws and regulations with respect to this procurement in the event of breach of contract by either party.

**(B) All contracts in excess of \$10,000 must address termination for cause and for convenience by the non-Federal entity including the manner by which it will be effected and the basis for settlement.**

Pursuant to Federal Rule (B) above, for all contracts involving Federal funds in excess of \$10,000, School Board reserves the right to terminate the contract (i) for convenience, and/or (ii) for cause by issuing a certified notice to the vendor.

**(C) Equal Employment Opportunity. Except as otherwise provided under 41 CFR Part 60, all contracts that meet the definition of "federally assisted construction contract" in 41 CFR Part 60-1.3 must include the equal opportunity clause provided under 41 CFR 60-1.4(b), in accordance with Executive Order 11246, "Equal Employment Opportunity" (30 FR 12319, 12935, 3 CFR Part, 1964-1965 Comp., p. 339), as amended by Executive Order 11375, "Amending Executive Order 11246 Relating to Equal Employment Opportunity," and implementing regulations at 41 CFR part 60, "Office of Federal Contract Compliance Programs, Equal Employment Opportunity, Department of Labor."**

Pursuant to Federal Rule (C) above, when School Board expends federal funds on any federally assisted construction contract, the equal opportunity clause is incorporated by reference herein.

**(D) Davis-Bacon Act, as amended (40 U.S.C. 3141-3148). When required by Federal program legislation, all prime construction contracts in excess of \$2,000 awarded by non-Federal entities must include a provision for compliance with the Davis-Bacon Act (40 U.S.C. 3141-3144, and 3146-3148) as supplemented by Department of Labor regulations (29 CFR Part 5, "Labor Standards Provisions Applicable to Contracts Covering Federally Financed and Assisted Construction"). In accordance with the statute, contractors must be required to pay wages to laborers and mechanics at a rate not less than the prevailing wages specified in a wage determination made by the Secretary of Labor. In addition, contractors must be required to pay wages not less than once a week. The non-Federal entity must place a copy of the current prevailing wage determination issued by the Department of Labor in each solicitation. The decision to award a contract or subcontract must be conditioned upon the acceptance of the wage determination. The non-Federal entity must report all suspected or reported violations to the Federal awarding agency. The contracts must also include a provision for compliance with the Copeland "Anti-Kickback" Act (40 U.S.C. 3145), as supplemented by Department of Labor regulations (29 CFR Part 3, "Contractors and Subcontractors on Public Building or Public Work Financed in Whole or in Part by Loans or Grants from the United States"). The Act provides that each contractor or subrecipient must be prohibited from inducing, by any means, any person employed in the construction, completion, or repair of public work, to give up any part of the compensation to which he or she is otherwise entitled. The non-Federal entity must report all suspected or reported violations to the Federal awarding agency.**

Pursuant to Federal Rule (D) above, when School Board expends federal funds during the term of an award for all contracts and subgrants for construction or repair, Vendor will be in compliance with all applicable Davis-Bacon Act provisions.

**(E) Contract Work Hours and Safety Standards Act (40 U.S.C. 3701-3708). Where applicable, all contracts awarded by the non-Federal entity in excess of \$100,000 that involve the employment of mechanics or laborers must include a provision for compliance with 40 U.S.C. 3702 and 3704, as supplemented by Department of Labor regulations (29**

## EDGAR CERTIFICATIONS (continued)

CFR Part 5). Under 40 U.S.C. 3702 of the Act, each contractor must be required to compute the wages of every mechanic and laborer on the basis of a standard work week of 40 hours. Work in excess of the standard work week is permissible provided that the worker is compensated at a rate of not less than one and a half times the basic rate of pay for all hours worked in excess of 40 hours in the work week. The requirements of 40 U.S.C. 3704 are applicable to construction work and provide that no laborer or mechanic must be required to work in surroundings or under working conditions which are unsanitary, hazardous or dangerous. These requirements do not apply to the purchases of supplies or materials or articles ordinarily available on the open market, or contracts for transportation or transmission of intelligence.

Pursuant to Federal Rule (E) above, when federal funds are expended by School Board, Vendor certifies that Vendor will be in compliance with all applicable provisions of the Contract Work Hours and Safety Standards Act during the term of an award resulting from this procurement process.

**(F) Rights to Inventions Made Under a Contract or Agreement.** If the Federal award meets the definition of “funding agreement” under 37 CFR §401.2 (a) and the recipient or subrecipient wishes to enter into a contract with a small business firm or nonprofit organization regarding the substitution of parties, assignment or performance of experimental, developmental, or research work under that “funding agreement,” the recipient or subrecipient must comply with the requirements of 37 CFR Part 401, “Rights to Inventions Made by Nonprofit Organizations and Small Business Firms Under Government Grants, Contracts and Cooperative Agreements,” and any implementing regulations issued by the awarding agency.

Pursuant to Federal Rule (F) above, when federal funds are expended by School Board, Vendor certifies that Vendor will be in compliance with all applicable provisions of Federal Rule (F) during the term of an award resulting from this procurement process.

**(G) Clean Air Act (42 U.S.C. 7401-7671q.) and the Federal Water Pollution Control Act (33 U.S.C. 1251-1387), as amended Contracts and subgrants of amounts in excess of \$150,000 must contain a provision that requires the non-Federal award to agree to comply with all applicable standards, orders or regulations issued pursuant to the Clean Air Act (42 U.S.C. 7401 7671q) and the Federal Water Pollution Control Act as amended (33 U.S.C. 1251-1387). Violations must be reported to the Federal awarding agency and the Regional Office of the Environmental Protection Agency (EPA).**

Pursuant to Federal Rule (G) above, when federal funds are expended by School Board, Vendor certifies that Vendor will be in compliance with all applicable provisions of Federal Rule (G) during the term of an award resulting from this procurement process.

**(H) Energy Policy and Conservation Act (42 U.S.C. 6201).** Vendor agrees to comply with the mandatory standards and policies relating to energy efficiency contained in the state energy conservation plan issued in compliance with the Energy Policy and Conservation Act.

Pursuant to Federal Rule (H) above, when federal funds are expended by School Board, Vendor certifies that Vendor will be in compliance with all applicable provisions of Federal Rule (H) during the term of an award resulting from this procurement process.

**(I) Debarment and Suspension (Executive Orders 12549 and 12689)—A contract award (see 2 CFR 180.220) must not be made to parties listed on the government wide exclusions in the System for Award Management (SAM), in accordance with the OMB guidelines at 2 CFR 180 that implement Executive Orders 12549 (3 CFR part 1986 Comp., p. 189) and 12689 (3 CFR part 1989 Comp., p. 235), “Debarment and Suspension.” SAM Exclusions contains the names of parties debarred, suspended, or otherwise excluded by agencies, as well as parties declared ineligible under statutory or regulatory authority other than Executive Order 12549.**

Pursuant to Federal Rule (I) above, when federal funds are expended by School Board, Vendor certifies that during the term of an award resulting from this procurement process, that neither it nor its principals are presently debarred, suspended, proposed for debarment, declared ineligible, or voluntarily excluded from participation by any federal department or agency.

**(J) Byrd Anti-Lobbying Amendment (31 U.S.C. 1352)—Contractors that apply or bid for an award exceeding \$100,000 must file the required certification. Each tier certifies to the tier above that it will not and has not used Federal appropriated funds to pay any person or organization for influencing or attempting to influence an officer or employee of any agency, a member of Congress, officer or employee of Congress, or an employee of a member of Congress in connection with obtaining any Federal contract, grant or any other award covered by 31 U.S.C. 1352.**

**EDGAR CERTIFICATIONS (continued)**

**Each tier must also disclose any lobbying with non-Federal funds that takes place in connection with obtaining any Federal award. Such disclosures are forwarded from tier to tier up to the non-Federal award.**

Pursuant to Federal Rule (J) above, Vendor certifies that it is in compliance with all applicable provisions of the Byrd Anti-Lobbying Amendment (31 U.S.C. 1352). The Vendor further certifies that: (1) No Federal appropriated funds have been paid or will be paid, by or on behalf of the undersigned, to any person for influencing or attempting to influence an officer or employee of an agency, a Member of Congress, an officer or employee of Congress, or an employee of a Member of Congress in connection with the awarding of any Federal contract, the making of any Federal grant, the making of any Federal loan, the entering into of any cooperative agreement, and the extension, continuation, renewal, amendment, or modification of any Federal contract, grant, loan, or cooperative agreement. (2) If any funds other than Federal appropriated funds have been paid to any person for influencing or attempting to influence an officer or employee of any agency, Member of Congress, an officer or employee of Congress, or an employee of a Member of Congress in connection with this Federal contract, grant, loan, or cooperative agreement, the undersigned shall complete and submit Standard Form-LLL, "Disclosure Form to Report Lobbying," in accordance with its instructions. (3) The undersigned shall require that the language of this certification be included in the award documents for all covered subawards in Federal funds at all appropriate tiers and that all subrecipients shall certify and disclose accordingly.

---

**RECORDS RETENTION**

---

Records Retention (2 C.F.R. § 200.333): Financial records, supporting documents, statistical records and all other non-Federal entity records pertinent to a Federal award must be retained for a period of three (3) years from the date of submission of the final expenditure report or, for Federal awards that are renewed quarterly or annually, from the date of the submission of the quarterly or annual financial report, respectively, as reported to the Federal awarding agency or passthrough entity in the case of a subrecipient.

---

**RECOVERED MATERIALS**

---

Recovered Materials (2 CFR §200.322): Contractor must comply with section 6002 of the Solid Waste Disposal Act, as amended by the Resource Conservation and Recovery Act. The requirements of Section 6002 include procuring only items designated in guidelines of the Environmental Protection Agency (EPA) at 40 CFR part 247 that contain the highest percentage of recovered materials practicable, consistent with maintaining a satisfactory level of competition, where the purchase price of the item exceeds \$10,000 or the value of the quantity acquired during the preceding fiscal year exceeded \$10,000; procuring solid waste management services in a manner that maximizes energy and resource recovery; and establishing an affirmative procurement program for procurement of recovered materials identified in the EPA guidelines.

**Vendor agrees to comply with all federal, state, and local laws, rules, regulations and ordinances, as applicable. It is further acknowledged that vendor certifies compliance with all provisions, laws, acts, regulations, etc. as specifically noted above.**

Vendor's Name: \_\_\_\_\_

Signature of Authorized Representative: \_\_\_\_\_

Print Name of Authorized Representative: \_\_\_\_\_

**Bid #2020-19 Lighting Retrofit**

**ST. JOHNS COUNTY SCHOOL DISTRICT**

**INVITATION TO BID**

**SPECIAL CONDITIONS**

1.0 **INTRODUCTION**

1.1 The St. Johns County School District (hereinafter referred to as SJCS D) is requesting bid pricing from qualified Contractors for LED Lighting Retrofit Kits to replace existing fluorescent bulbs. LED Strips and additional service will be purchased by SJCS D on an as needed basis. SJCS D makes no guarantee of a specific amount of products or services to be purchased.

1.2 **All Vendors requiring access to schools and facilities will be required to participate in a COVID-19 Health Screening Process. This will remain in effect until further notice.**

2.0 **INSTRUCTIONS FOR BID SUBMITTAL**

2.1 All bids must be received no later than, July 15, 2020 @ 1:30 PM and must be delivered to:

St. Johns County School District  
Sebastian Administrative Annex  
Purchasing Department  
3015 Lewis Speedway, Building 5  
St. Augustine, FL 32084

If a bid is transmitted by US mail or other delivery medium, the bidder will be responsible for its timely delivery to the address indicated

2.2 Any bid received after the stated date and time, **WILL NOT** be considered.

2.3 One manually signed original bid and one photocopy of the bid must be sealed in one package and clearly labeled "Bid #2020-19 Lighting Retrofit" on the outside of the package. The legal name, address, bidder's contact person and telephone number must also be clearly noted on the outside of the package.

The manually signed original shall be clearly marked as "ORIGINAL". Once accepted, all original proposals and any copies of proposals become the sole property of SJCS D and may be retained by SJCS D or disposed of in any manner SJCS D deems appropriate.

2.4 Failure to submit one original bid with a manual signature may result in rejection of the bid.

## **Bid #2020-19 Lighting Retrofit**

- 2.5 All bids must be signed by an officer or employee having the authority to legally bind the bidder.
- 2.6 Any corrections must be initialed. This includes corrections made using correction fluid (white out) or any other method of correction.
- 2.7 Bidders should become familiar with any local conditions that may, in any manner, affect the services required. The bidder(s) are required to carefully examine the bid terms and to become thoroughly familiar with any and all conditions and requirements that may in any manner affect the work to be performed under the contract. No additional allowance will be made due to lack of knowledge of these conditions.
- 2.8 Bids not conforming to the instructions provided herein will be subject to disqualification at the sole discretion of SJCS D.
- 2.9 Any bid may be withdrawn prior to the date and time the bids are due. Any bid not withdrawn will constitute an irrevocable offer for a period of 90 days, to provide SJCS D with the services specified in the bid.
- 2.10 Pursuant to Florida Statute, it is the practice of SJCS D to make available for public inspection and copying any information received in response to an Invitation to Bid or Request for Proposal (RFP). No action on the part of the respondent to a Bid or RFP will create an obligation of confidentiality on the part of SJCS D, including but not limited to, making a reference in the response to the trade secret statutes. It is recommended that potential suppliers exclude from their response any information that, in their judgment may be considered a trade secret.
- 2.11 When a school district is required to make purchases of personal property through competitive solicitation and the lowest responsible and responsive bid, proposal or reply is by a vendor whose principal place of business is in a state or political subdivision which grants a preference by that state or political subdivision, then the school district shall award an equal preference to the lowest responsible and responsive vendor having a principal place of business within Florida. In a competitive solicitation in which the lowest bid is submitted by a vendor whose principal place of business is located outside the state, and that state does not grant a preference in competitive solicitation to vendors having a principal place of business in that state, the preference to the lowest responsible and responsive vendor having a principal place of business in the State of Florida shall be five (5) percent. F.S. 287.084(1)(a).

A vendor whose principal place of business is outside this state must accompany any written bid, proposal or reply documents with a written opinion of an attorney at law licensed to practice law in that foreign state, as to the preferences, if any or none, granted by the law of that state to its own business entities whose principal places of business are in that foreign state in the letting of any or all public contracts. F.S. 287.084(2).

## 3.0 **AWARD**

## **Bid #2020-19 Lighting Retrofit**

- 3.1 SJCS D reserves the right to waive any irregularities and technicalities and may, at its sole discretion, request a re-submittal or other information to evaluate any or all bids.
- 3.2 SJCS D reserves the right to require bidder(s) to submit evidence of qualifications or any other information the Board may deem necessary, including audited and unaudited financial statements.
- 3.3 SJCS D reserves the right, prior to Board approval, to withdraw the bid or portions thereof, without penalty.
- 3.4 SJCS D reserves the right to: (1) accept the bid of any firm to be in the best interest of the school district and (2) to reject any and/or all bids.
- 3.5 SJCS D reserves the right to conduct interviews with any of the bidders and to require a formal presentation by any of the bidders.
- 3.6 It is the intent of SJCS D to award this bid to one or more sources, as determined to be in the best interest of SJCS D.
- 3.7 The bid award will be made based on funds availability and will be at the sole discretion of the St. Johns County School Board.

### **4.0 CONTRACT/RENEWAL**

- 4.1 The term of this contract shall be from October 1, 2020 to September 30, 2021 and may by mutual agreement between SJCS D and the awarded Contractor be renewable for up to three (3) additional one (1) year periods.
- 4.2 All terms and conditions of this bid, any addenda, and negotiated terms are incorporated into the contract by reference as set forth herein.

### **5.0 BID INQUIRIES/NOTICES**

- 5.1 Any questions and inquiries concerning the Bid must be submitted via email to Patrick Snodgrass of the SJCS D Purchasing Department no later than June 29, 2020 @ 12:00 PM to:

Patrick Snodgrass  
Director of Purchasing  
[patrick.snodgrass@stjohns.k12.fl.us](mailto:patrick.snodgrass@stjohns.k12.fl.us)

Questions and inquiries received after the said date will not be considered. Questions and inquiries must reference the Bid number.

- 5.2 Those interpretations or responses to all questions and inquiries which may affect the eventual outcome of this solicitation will be posted to the DemandStar website [www.demandstar.com](http://www.demandstar.com) for all prospective Bidders to view no later than 5:00 PM, July 1,

## Bid #2020-19 Lighting Retrofit

2020.

Only the interpretation or response given by the SJCS D Purchasing Department representative, in writing, shall be binding and prospective Bidders are advised that no other source is authorized to give information concerning, or to explain or interpret the Invitation to Bid. All such interpretations and supplemental instructions will be in the form of written Addenda to the Invitation to Bid.

- 5.3 Copies of addendum will also be made available for inspection at SJCS D's Purchasing Department where bid documents will be kept on file.
- 5.4 No Addendum will be issued later than July 1, 2020, except an addendum withdrawing the Invitation to Bid or one which includes postponement of the date for receipt of bids or one containing the questions and answers.
- 5.5 School board members, and school board personnel (except the Purchasing Department representative referenced above) are ***not to be contacted*** prior to the School Board's decision to approve or reject the final recommendation presented to it by the Superintendent. At the discretion of SJCS D, failure to comply with this requirement will be grounds for disqualification.

Specifically, this **NO-CONTACT PERIOD** shall commence on the initial date of the advertisement for Request for Proposals and continue through and include the date the St. Johns County School Board makes its determination to approve or reject the final recommendations.

Failure to meet any of these requirements may disqualify a Respondent from consideration.

### 6.0 **SCOPE OF SERVICES**

- 6.1 This bid is for LED Lighting Retrofit kits, LED Troffer kits, turnkey installation, additional work, and a percentage markup over cost for other materials. SJCS D makes no guarantee of the amount of services or quantity of products to be purchased under this bid.
- 6.2 The awarded Contractor is responsible for supplying, at its own expense, all supervision, labor, equipment, machines, tools, materials, transportation and anything necessary to perform work. SJCS D will not purchase, lease or otherwise acquire any equipment for use by the awarded Contractor in performance of work under this bid.
- 6.3 When a particular brand/make/stock number is listed in the bid, such reference has been made solely for the purpose of more clearly defining the general description and the standard of minimum quality and construction. If an alternate product is proposed, it is the Bidder's responsibility to submit literature and detailed specifications of the alternate



## **Bid #2020-19 Lighting Retrofit**

product with their bid. SJCS D shall be the sole judge in the exercise of its discretion for determining whether the alternate product is equal and acceptable.

### **6.4 NetZero 40-Watt LED Strip Retrofit Kit NZLED 9844**

40-Watt LED Retrofit Kit must meet or exceed specifications for Net Zero USA 40-Watt LED Strips. See Attachment A.

### **6.5 NetZero 40-Watt LED Strip Retrofit Kit NZLED 9844 Installed by SJCS D Personnel**

The awarded Contractor shall provide Net Zero USA 40-Watt LED Strips for

- 2'x2' (4 strip)
- 2'x4' (8 strip)

### **6.6 NetZero Turnkey Installation of 40-Watt LED Strip Retrofit Kit NZLED 9844 Installed by Awarded Contractor**

The purchase, delivery and turnkey installation of Net Zero USA 40-Watt LED Strips for

- 2'x2' (4 strip)
- 2'x4' (8 strip)

The turnkey installation shall include the removal and disposal of existing bulbs and installation of Net Zero USA 40-Watt LED Strips. All installations shall be in accordance with manufacturer's recommendations.

Installation shall be performed by a licensed electrical contractor. All installation work shall be scheduled and coordinated with an authorized SJCS D representative.

Upon completion of the installation, lighting equipment must be in operating order and free from defects in condition and finish. Fixtures shall be completely clean and free from finger marks and dust. Any reflectors, lenses, diffusers, side panels or other parts damaged prior to the final inspection shall be replaced at no expense to SJCS D.

### **6.7 Columbia Lighting LJT24 2'x4' LED Troffer Kit**

Troffer Kit must meet or exceed specifications for Columbia Lighting LJT24 2'x4' LED Troffer Kit. See attachment B.

### **6.8 Columbia Lighting LJT24 2'x4' LED Troffer Kit Installed by SJCS D Personnel**

The awarded Contractor shall provide Columbia Lighting LJT24 2'x4' LED Troffer Kit.

### **6.9 Columbia Lighting Turnkey Installation of LJT24 2'x4' LED Troffer Kit Installed by Awarded Contractor**

## **Bid #2020-19 Lighting Retrofit**

The purchase, delivery and turnkey installation of Columbia Lighting LJT24 2'x4' LED Troffer Kit.

The turnkey installation shall include the removal and disposal of existing troffer and bulbs and installation of Columbia Lighting LJT24 2'x4' LED Troffer Kit. All installations shall be in accordance with manufacturer's recommendations.

Installation shall be performed by a licensed electrical contractor. All installation work shall be scheduled and coordinated with an authorized SJCSO representative.

Upon completion of the installation, lighting equipment must be in operating order and free from defects in condition and finish. Fixtures shall be completely clean and free from finger marks and dust. Any reflectors, lenses, diffusers, side panels or other parts damaged prior to the final inspection shall be replaced at no expense to SJCSO.

### **6.10 Additional Electrical Services**

Additional electrical services may be required at various facilities on an as needed basis by SJCSO. Rates are to be provided for a journeyman and a helper as indicated on the bid sheet. Work performed by a Helper must be under the direction of a Journeyman.

The awarded Contractor may be required to provide a written job quote for additional electrical services performed under this bid. The awarded Contractor bid pricing will be used as the basis for each job quote. Each job quote must contain a detailed listing of hours and hourly cost required to complete the job, plus a detailed listing of parts and accessories (materials) required to complete the job. The listing of parts and accessories must include the awarded Contractor cost and price to SJCSO based on the percentage (%) markup bid by the awarded Contractor. SJCSO reserves the right to require the awarded Contractor to provide documentation to substantiate their material cost.

- 6.11 SJCSO reserves the right to inspect all work prior to payment. Final project approval is contingent on the final inspection by an authorized SJCSO representative. The awarded Contractor shall promptly correct all work rejected by an authorized SJCSO representative.
- 6.12 It shall be the sole responsibility of the awarded Contractor performing services for this contract to safeguard their own materials, tools and equipment. SJCSO shall not assume any responsibility for vandalism and/or theft of materials, tools, and/or equipment.
- 6.13 The awarded Contractor shall be responsible for the removal and disposal of all light fixtures, bulbs and other materials under this bid. The Contractor must remove materials from the work site on a daily basis, or may arrange for a dumpster at their cost to be placed at the work site. The awarded Contractor will not be permitted to dispose of any material in any dumpster or trash receptacle that is paid for by SJCSO.

## **Bid #2020-19 Lighting Retrofit**

6.14 The awarded Contractor shall be responsible for any damage to SJCSO property, personnel property or visitor property due to negligence on the part of the awarded Contractor, its employees or its agents. The awarded Contractor agrees to repair, at own expense, any damage caused by the awarded Contractor, its employees or its agents.

### **7.0 BID PRICING**

7.1 Bidders are required to provide a price for the purchase and delivery of Net Zero 40-Watt Retrofit Kit NZLED 9844 for a 2'x2' and a 2'x4' unit.

7.2 Bidders are required to provide a price for the purchase, delivery and turnkey installation of Net Zero 40-Watt Retrofit Kit NZLED 9844 for a 2'x2' and a 2'x4' unit. Bid pricing shall include any and all costs incurred in the turnkey installation. No additional costs shall be incurred by SJCSO.

7.3 Bidders are required to provide a price for the purchase and delivery of Columbia Lighting LJT24 2'x4' LED Troffer kit.

7.4 Bidders are required to provide a price for the purchase, delivery and turnkey installation of Columbia Lighting LJT24 2'x4' LED Troffer kit. Bid pricing shall include any and all costs incurred in the turnkey installation. No additional costs shall be incurred by SJCSO.

7.5 Bid prices must incorporate any and all goods and services necessary to complete the work in this bid. No additional fees or charges of any kind not listed in the bid sheet will be accepted by SJCSO unless accompanied by an authorized change order.

7.6 Bidders are required to provide an hourly rate for a journeyman and a helper for repair work and additional work. The billable hourly rate shall start upon arrival at the job site and end upon departure from site.

7.7 Bidders are required to provide a percentage (%) markup over cost for additional parts and materials.

7.8 The bid sheet must be signed by an individual of the bidding firm that has the authority to bind the firm.

### **8.0 QUALIFICATIONS**

8.1 Contractors are required to include a copy of their Business Tax Receipt, valid in St. Johns County, in their bid submittal.

8.2 Turnkey installations may only be done by individuals which possess a current electrical license valid in the State of Florida. Prior to any work for turnkey installations the awarded Contractor must provide a copy of the current electrical license valid in the State of Florida for the individual providing the installation.

## **Bid #2020-19 Lighting Retrofit**

### **9.0 REFERENCES**

All bidders must provide a minimum of three (3) references whom they have performed similar services for within the past five (5) years.

### **10.0 INSURANCE REQUIREMENTS**

It is mandatory that the person/firm submitting the bid have minimum Liability limits of \$1,000,000.00 for both Comprehensive General Liability, including Product Liability Coverage. The person/firm submitting the bid must also have a minimum Liability Limit of \$1,000,000.00 for Motor Vehicle Liability and at least the statutory limit of Worker's Compensation. All coverage must be included on the certificate(s). Bidder's insurance provider must be rated A- or better by AM Best. If the bidder's current certificate of insurance does not meet the amount required, a statement must be included with the bid document from their insurance carrier indicating that if a bid award was made to the firm, that the carrier would write the necessary insurance coverage. The successful bidder must then have the required insurance placed in force with written notification provided to the Director of Purchasing, prior to issuance of a purchase order that authorizes the work performance to begin. Failure to do so may invalidate the award and result in an award to the next lowest responsible bidder. **Successful Contractor must list St. Johns County School Board as an additional insured.**

### **11.0 CONTRACTOR PAYMENT**

The St. Johns County School District requires all Contractors responding to this bid to accept payment from SJCS D on a Visa credit card. No other payment options will be made available. St. Johns County School District will issue a unique "ghost" credit card number to each Contractor. This information must be held on file for all future payments. The card has a zero balance until payments have been authorized by SJCS D.

After goods are delivered or services rendered Contractors submit invoices to the Accounts Payable Department according to the current process. The payment terms are set as IMMEDIATE (next accounts payable run). When payments are authorized, an email notification is sent to an email address provided by the Contractor. The email notification includes the invoice number, invoice date, and amount of payment. Once the Contractor receives the email the credit card has been authorized to charge for the amount listed in the email. When the Contractor charges the full amount authorized in the email the card will return to a zero balance until the next payment is authorized.

### **12.0 PURCHASE ORDERS**

A Purchase Order issued by the Purchasing Department or from School Internal Accounts is the only legal authorization for Contractors to perform services or provide commodities to SJCS D. A commitment, either written or verbal, from SJCS D employees without a Purchase Order issued by the Purchasing Department or from School Internal Accounts does not constitute an obligation by SJCS D to a Contractor. Contractors that perform

## **Bid #2020-19 Lighting Retrofit**

services or provide commodities without a Purchase Order issued by the Purchasing Department or from School Internal Accounts do so at their own risk and at risk of non-payment. Additional information regarding doing business with SJCSJ can be found on the SJCSJ web site, [www.stjohns.k12.fl.us](http://www.stjohns.k12.fl.us) under the Purchasing Department.

### 13.0 **PREPARATION AND SUBMISSION OF BID**

13.1 Bidder's are requested to organize their bids in the following sequence.

13.2 **Invitation to Bid:** Required response form (page 1 of Bid) with all required information completed and all signatures as specified

13.3 **Debarment Form**

13.4 **Drug Free Workplace Certification**

13.5 **Principal Place of Business**

13.6 **EDGAR Certifications**

13.7 **Insurance Coverage:** Insurance certificates evidencing coverage as specified in section 10.0 or a signed statement indicating that coverage meeting the required coverage will be obtained prior to the commencement of any work under this bid.

13.8 **Qualifications**

13.9 **References**

13.10 **Bid Sheet**

	Price
Purchase and Delivery of Net Zero 40-Watt Retrofit Kit NZLED 9844 for a 2'x2' Unit	\$
Purchase and Delivery of Net Zero 40-Watt Retrofit Kit NZLED 9844 for a 2'x4' Unit	\$
Purchase, Delivery and Turnkey Installation for Net Zero 40 Watt Retrofit Kit NZLED 9844 for a 2' x 2' Unit	\$
Purchase, Delivery and Turnkey Installation for Net Zero 40 Watt Retrofit Kit NZLED 9844 for a 2' x 4' Unit	\$
Purchase and Delivery of Columbia Lighting LJT24 2'x4' LED Troffer Kit	\$
Purchase, Delivery and Turnkey Installation for Columbia Lighting LJT24 2'x4' LED Troffer Kit	
Hourly Labor Rate for Additional Work - Journeyman	\$ Per Hour
Hourly Labor Rate for Additional Work - Helper	\$ Per Hour
Percentage (%) Markup Over Cost for Additional Parts and Materials	%
If applicable, bidder must list alternate ("or equal") product to Net Zero 40-Watt Retrofit Kit NZLED 9844	
If applicable, bidder must list alternate ("or equal") product to Columbia Lighting LJT24 2'x4' LED Troffer Kit	

**Vendor Acknowledgement and Approval**

I certify that this bid is made without prior understanding, agreement or connection with any corporation, firm or person submitting a bid for the same materials, supplies, equipment or services, and in all respects fair and without collusion or fraud. The following information, including an authorized representative signature, is required to be submitted with your bid in order to be considered for evaluation and award. The person signing below acknowledges and agrees with all proposed information as submitted and has the authorization of the said company to enter into a contractual agreement with the St. Johns County School District for the purposes as proposed and described herein.

Company Name: \_\_\_\_\_

Authorized Signature: \_\_\_\_\_

Print Name: \_\_\_\_\_

Date: \_\_\_\_\_

Project Name: \_\_\_\_\_  
 Series P/Ns: \_\_\_\_\_  
 Prepared By: \_\_\_\_\_  
 Date: \_\_\_\_\_

**SERIES FEATURES**

- ✓ American Designed & Engineered
- ✓ 10 Year, Non-prorated Warranty on Diodes and Driver
- ✓ Exclusive NetZero USA® Performance Guarantee
- ✓ Robust Performance & Long Life
- ✓ DLC and UL 1598C Listed

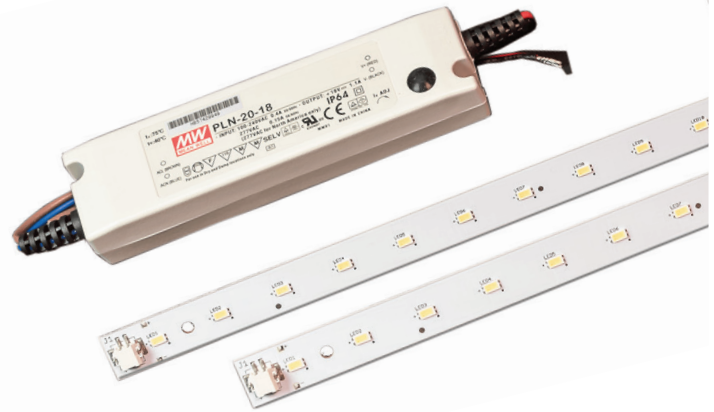

NZLED® 9822 20W Strip Kit pictured above.

**PRODUCT INFO**

	■ NZLED® 9822	■ NZLED® 9834	■ NZLED® 9844	■ NZLED® 9844-D	■ NZLED® 9844-IO	■ NZLED® 9866	■ NZLED® 9868
<b>Description</b>	Standard	Standard	Standard	Dimmable	Inboard/Outboard	Standard	Standard
<b>Type</b>	Retrofit	Retrofit	Retrofit	Retrofit	Retrofit	Retrofit	Retrofit
<b>Input Power</b>	20W	30W	40W	40W	40W	60W	60W
<b>Input Voltage</b>	AC100-277V	AC100-277V	AC100-277V	AC100-277V	AC100-277V	AC100-277V	AC100-277V
<b>IP Rating</b>	IP67	IP67	IP67	IP67	IP67	IP67	IP67
<b>Lumens</b>	2044-2814	2814-3318	3432-4544	4202-4454	4120-4280	6241-6615	6241-6615
<b>Applications</b>	Interior	Interior	Interior	Interior	Interior	Interior	Interior
<b>Warranty</b>	10 Years	10 Years	10 Years	10 Years	10 Years	10 Years	10 Years
<b>L70 Lifetime</b>	>100K Hours	>100K Hours	>100K Hours	>100K Hours	>100K Hours	>100K Hours	>100K Hours
<b>Strips</b>	2	4	4	4	4	6	8
<b>Driver</b>	NZUSA / Mean Well	NZUSA / Mean Well	NZUSA / Mean Well	NZUSA / Mean Well	NZUSA / MW (2)	NZUSA / Mean Well	NZUSA / Mean Well
<b>Operating Temp.</b>	23°F TO 122°F	23°F TO 122°F	23°F TO 122°F	23°F TO 122°F	23°F TO 122°F	23°F TO 122°F	23°F TO 122°F
<b>Grounded</b>	YES	YES	YES	YES	YES	YES	YES
<b>480V</b>	✗	✗	✗	✗	✗	✗	✗
<b>Dimmable</b>	✗	✗	✗	✓	✗	✗	✗
<b>Dark Sky</b>	✗	✗	✗	✗	✗	✗	✗
<b>Available Kelvins</b>	3500K, 4000K, 5000K	3500K, 4000K, 5000K	3500K, 4000K, 5000K	3500K, 4000K, 5000K	3500K, 4000K, 5000K	3500K, 4000K, 5000K	3500K, 4000K, 5000K
<b>Housing Color</b>	✗	✗	✗	✗	✗	✗	✗
<b>Accessories</b>	9290, 9291, 9292, 9293, 9294	9290, 9291, 9292, 9293, 9294	9290, 9291, 9292, 9293, 9294	9290, 9291, 9292, 9293, 9294	9290, 9291, 9292, 9293, 9294	9290, 9291, 9292, 9293, 9294	9290, 9291, 9292, 9293, 9294

**CERTIFICATIONS**

	■ NZLED® 9822	■ NZLED® 9834	■ NZLED® 9844	■ NZLED® 9844-D	■ NZLED® 9844-IO	■ NZLED® 9866	■ NZLED® 9868
<b>DLC Listed</b>	✓	✓	✓	✓	✗ *9822 (x2)	✓	✗ *9866 (+9291)
<b>UL 1598C Listed</b>	✓	✓	✓	✓	✓	✓	✓
<b>ETL Listed</b>	✗	✗	✗	✗	✗	✗	✗
<b>Energy Star</b>	✗	✗	✗	✗	✗	✗	✗



NZLED<sup>®</sup> 9822 pictured above.

SERIES PHOTOS

NZLED<sup>®</sup> 9834



30W 4-Strip Retrofit Kit

NZLED<sup>®</sup> 9822/9844-10



40W 4-Strip Inboard/Outboard Retrofit Kit

NZLED<sup>®</sup> 9844



40W 4-Strip Retrofit Kit

NZLED<sup>®</sup> 9866



60W 6-Strip Retrofit Kit

NZLED<sup>®</sup> 9844-D



40W 4-Strip Dimmable Retrofit Kit

NZLED<sup>®</sup> 9868



60W 8-Strip Retrofit Kit





NZLED® 9822 pictured above.

**PERFORMANCE DATA**

NZLED® 9822	Kelvin	Application	Lumens	Wattage	Efficacy	Pwr Factor	CCT	CRI	Harmonic Dist
<input type="checkbox"/>	5000K	Indoor Retrofit Kits: 1x4 Troffer	2814	26.58	106	0.898	5156	80.8	18.10%
<input type="checkbox"/>	5000K	Indoor Retrofit Kits: 2x2 Troffer	2267	20.29	111.7	0.898	5156	80.8	18.10%
<input type="checkbox"/>	4000K	Indoor Retrofit Kits: 1x4 Troffer	2150	20.26	106.1	0.898	4000	81.2	18.10%
<input type="checkbox"/>	4000K	Indoor Retrofit Kits: 2x2 Troffer	2203	20.31	108.4	0.898	4000	81.1	18.10%
<input type="checkbox"/>	3500K	Indoor Retrofit Kits: 1x4 Troffer	2044	20.29	100.8	0.898	3228	82.9	18.10%
<input type="checkbox"/>	3500K	Indoor Retrofit Kits: 2x2 Troffer	2044	20.29	100.8	0.898	3237	82.8	18.10%

NZLED® 9834	Kelvin	Application	Lumens	Wattage	Efficacy	Pwr Factor	CCT	CRI	Harmonic Dist
<input type="checkbox"/>	5000K	Indoor Retrofit Kits: 1x4 Troffer	2814	26.58	106	0.97	5156	80.8	15.70%
<input type="checkbox"/>	5000K	Indoor Retrofit Kits: 2x4 Troffer	3318	26.64	124.2	0.873	5156	80.8	15.70%
<input type="checkbox"/>	5000K	Indoor Retrofit Kits: 2x2 Troffer	3115	26.62	116.6	0.873	5156	80.8	15.70%
<input type="checkbox"/>	4000K	Indoor Retrofit Kits: 2x4 Troffer	3224	26.67	120.7	0.873	4000	82.1	15.70%
<input type="checkbox"/>	4000K	Indoor Retrofit Kits: 2x2 Troffer	3027	26.6	113.3	0.873	4000	81.3	15.70%
<input type="checkbox"/>	3500K	Indoor Retrofit Kits: 2x4 Troffer	3052	26.7	114.1	0.973	3212	83	15.70%
<input type="checkbox"/>	3500K	Indoor Retrofit Kits: 2x2 Troffer	2939	26.68	110	0.873	3229	83	15.70%

NZLED® 9844	Kelvin	Application	Lumens	Wattage	Efficacy	Pwr Factor	CCT	CRI	Harmonic Dist
<input type="checkbox"/>	5000K	Indoor Retrofit Kits: 1x4 Troffer	3638	34.86	104.3	0.887	5156	80.8	17.60%
<input type="checkbox"/>	5000K	Indoor Retrofit Kits: 2x4 Troffer	4544	34.93	130	0.887	5156	80.8	17.60%
<input type="checkbox"/>	5000K	Indoor Retrofit Kits: 2x4 Troffer	4056	34.86	116.4	0.887	5156	80.8	17.60%
<input type="checkbox"/>	4000K	Indoor Retrofit Kits: 1x4 Troffer	3534	34.9	101.3	0.887	4000	82.1	17.60%
<input type="checkbox"/>	4000K	Indoor Retrofit Kits: 2x4 Troffer	4415	34.96	126.3	0.887	4000	82.1	17.60%
<input type="checkbox"/>	4000K	Indoor Retrofit Kits: 2x2 Troffer	3940	34.9	112.9	0.887	4000	82.1	17.60%
<input type="checkbox"/>	3500K	Indoor Retrofit Kits: 1x4 Troffer	3432	34.93	98.3	0.887	3268	83	17.60%
<input type="checkbox"/>	3500K	Indoor Retrofit Kits: 2x2 Troffer	3826	34.93	109.5	0.887	3268	83	17.60%
<input type="checkbox"/>	3500K	Indoor Retrofit Kits: 2x4 Troffer	4287	35	122	0.887	3217	82.9	17.60%

NZLED® 9844-D	Kelvin	Application	Lumens	Wattage	Efficacy	Pwr Factor	CCT	CRI	Harmonic Dist
<input type="checkbox"/>	5000K	Indoor Retrofit Kits: 2x4 Troffer	4454	36.53	123.9	0.892	5156	80.8	16.40%
<input type="checkbox"/>	4000K	Indoor Retrofit Kits: 2x4 Troffer	4328	36.53	120.4	0.892	4000	81.1	16.40%
<input type="checkbox"/>	3500K	Indoor Retrofit Kits: 2x4 Troffer	4202	35.96	116.9	0.892	3247	82.7	16.40%

NZLED® 9866	Kelvin	Application	Lumens	Wattage	Efficacy	Pwr Factor	CCT	CRI	Harmonic Dist
<input type="checkbox"/>	5000K	Indoor Retrofit Kits: 2x4 Troffer	6615	53.42	123.8	0.895	5156	80.8	18.20%
<input type="checkbox"/>	4000K	Indoor Retrofit Kits: 2x4 Troffer	6428	53.42	120.3	0.895	4000	81.1	18.20%
<input type="checkbox"/>	3500K	Indoor Retrofit Kits: 2x4 Troffer	6241	53.42	116.8	0.895	3246	82.7	18.20%



NZLED<sup>®</sup> 9822 pictured above.

**SERIES CERTIFICATIONS**

NZLED <sup>®</sup> 9822	Kelvin	Application	Model #	DLC ID	UL	ETL	Energy Star
<input type="checkbox"/>	5000K	Indoor Retrofit Kits: 1x4 Troffer	NZ-20-9822 (5000K)	P9EYAVNT	E466556	✘	✘
<input type="checkbox"/>	5000K	Indoor Retrofit Kits: 2x2 Troffer	NZ-20-9822 (5000K)	P93PSW6R	E466556	✘	✘
<input type="checkbox"/>	4000K	Indoor Retrofit Kits: 1x4 Troffer	NZ-20-9822 (4000K)	P4PZEJG7	E466556	✘	✘
<input type="checkbox"/>	4000K	Indoor Retrofit Kits: 2x2 Troffer	NZ-20-9822 (4000K)	P9CTAH9U	E466556	✘	✘
<input type="checkbox"/>	3500K	Indoor Retrofit Kits: 1x4 Troffer	NZ-20-9822 (3500K)	P5S9H5HF	E466556	✘	✘
<input type="checkbox"/>	3500K	Indoor Retrofit Kits: 2x2 Troffer	NZ-20-9822 (3500K)	PHFTW2FV	E466556	✘	✘

NZLED <sup>®</sup> 9834	Kelvin	Application	Model #	DLC ID	UL	ETL	Energy Star
<input type="checkbox"/>	5000K	Indoor Retrofit Kits: 1x4 Troffer	NZ-30-9834 (5000K)	PFMZ57Q	E466556	✘	✘
<input type="checkbox"/>	5000K	Indoor Retrofit Kits: 2x4 Troffer	NZ-30-9834 (5000K)	P9XAP1X6	E466556	✘	✘
<input type="checkbox"/>	5000K	Indoor Retrofit Kits: 2x2 Troffer	NZ-30-9834 (5000K)	PM4SFB1R	E466556	✘	✘
<input type="checkbox"/>	4000K	Indoor Retrofit Kits: 2x4 Troffer	NZ-30-9834 (4000K)	P44CECXZ	E466556	✘	✘
<input type="checkbox"/>	4000K	Indoor Retrofit Kits: 2x2 Troffer	NZ-30-9834 (4000K)	PX3SW142	E466556	✘	✘
<input type="checkbox"/>	3500K	Indoor Retrofit Kits: 2x4 Troffer	NZ-30-9834 (3500K)	PU9XBN4T	E466556	✘	✘
<input type="checkbox"/>	3500K	Indoor Retrofit Kits: 2x2 Troffer	NZ-30-9834 (3500K)	PVBK7AS2	E466556	✘	✘

NZLED <sup>®</sup> 9844	Kelvin	Application	Model #	DLC ID	UL	ETL	Energy Star
<input type="checkbox"/>	5000K	Indoor Retrofit Kits: 1x4 Troffer	NZ-40-9844 (5000K)	PPSHXHJ	E466556	✘	✘
<input type="checkbox"/>	5000K	Indoor Retrofit Kits: 2x4 Troffer	NZ-40-9844 (5000K)	P7YD7HJF	E466556	✘	✘
<input type="checkbox"/>	5000K	Indoor Retrofit Kits: 2x4 Troffer	NZ-40-9844 (5000K)	PAM6XH5X	E466556	✘	✘
<input type="checkbox"/>	4000K	Indoor Retrofit Kits: 1x4 Troffer	NZ-40-9844 (4000K)	P3PWMT45	E466556	✘	✘
<input type="checkbox"/>	4000K	Indoor Retrofit Kits: 2x4 Troffer	NZ-40-9844 (4000K)	PWMYMRA	E466556	✘	✘
<input type="checkbox"/>	4000K	Indoor Retrofit Kits: 2x2 Troffer	NZ-40-9844 (4000K)	P1VNQFKS	E466556	✘	✘
<input type="checkbox"/>	3500K	Indoor Retrofit Kits: 1x4 Troffer	NZ-40-9844 (3500K)	P9F57K2K	E466556	✘	✘
<input type="checkbox"/>	3500K	Indoor Retrofit Kits: 2x2 Troffer	NZ-40-9844 (3500K)	PSZMC5UQ	E466556	✘	✘
<input type="checkbox"/>	3500K	Indoor Retrofit Kits: 2x4 Troffer	NZ-40-9844 (3500K)	PA4WF3B4	E466556	✘	✘

NZLED <sup>®</sup> 9844-D	Kelvin	Application	Model #	DLC ID	UL	ETL	Energy Star
<input type="checkbox"/>	5000K	Indoor Retrofit Kits: 2x4 Troffer	NZ-40D-9844 (5000K)	PQZAJNVA	E466556	✘	✘
<input type="checkbox"/>	4000K	Indoor Retrofit Kits: 2x4 Troffer	NZ-40D-9844 (4000K)	PXUECXSA	E466556	✘	✘
<input type="checkbox"/>	3500K	Indoor Retrofit Kits: 2x4 Troffer	NZ-40D-9844 (3500K)	PQ3FTUJ8	E466556	✘	✘

NZLED <sup>®</sup> 9866	Kelvin	Application	Model #	DLC ID	UL	ETL	Energy Star
<input type="checkbox"/>	5000K	Indoor Retrofit Kits: 2x4 Troffer	NZ-60-9866 (5000K)	PHGC8S49	E466556	✘	✘
<input type="checkbox"/>	4000K	Indoor Retrofit Kits: 2x4 Troffer	NZ-60-9866 (4000K)	PZVYSJEU	E466556	✘	✘
<input type="checkbox"/>	3500K	Indoor Retrofit Kits: 2x4 Troffer	NZ-60-9866 (3500K)	PJRX1GYC	E466556	✘	✘



NZLED<sup>®</sup> 9822 pictured above.

**SERIES ACCESSORIES**

	9290	9291	9292	9293	9294
<b>Description</b>	46.5" Curved Diffuser	2 Strip Adder	2'x4' Diffuser	Switch Base	Parts Kit
<b>Fits Products</b>	9834, 9844, 9844-D, 9844-I0, 9866, 9868	9834, 9844, 9844-D, 9844-I0, 9866, 9868	9834, 9844, 9844-D, 9844-I0, 9866, 9868	9834, 9844, 9844-D, 9844-I0, 9866, 9868	9834, 9844, 9844-D, 9844-I0, 9866, 9868

**ACCESSORY PHOTOS**

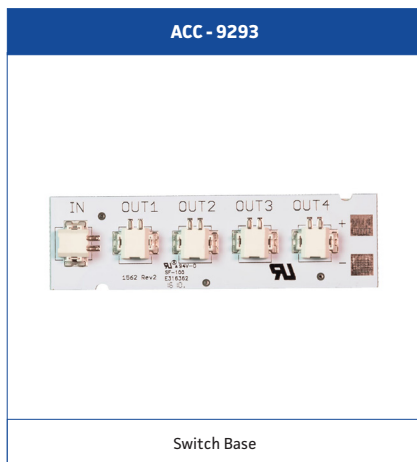
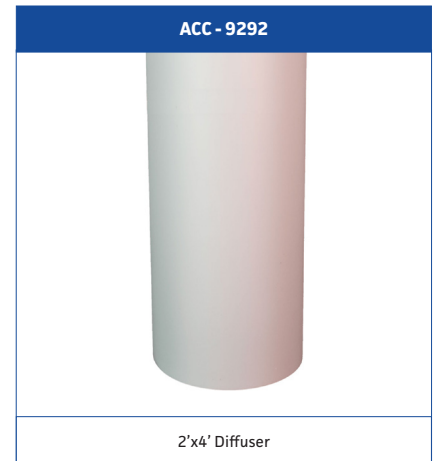



NZLED<sup>®</sup> 9822 pictured above.

SERIES DIMENSIONS

**NZLED<sup>®</sup> 9822**

*Configuration for 2 Lamp 2'x2'*

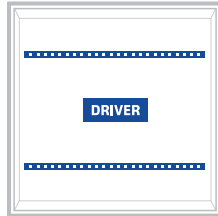

*Configuration for 2 Lamp 1'x4'*



Recommended Strip Configurations

**NZLED<sup>®</sup> 9834**

*Configuration for 2 Lamp 2'x2'*

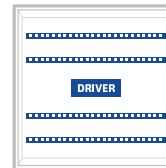

*Configuration for 2 Lamp 1'x4'*



*Configuration for 2 or 4 Lamp 2'x4'*

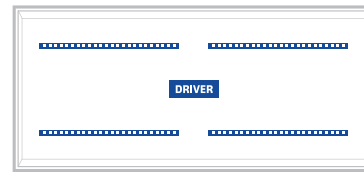

Recommended Strip Configurations

**NZLED<sup>®</sup> 9844**

*Standard configuration for 2'x2', 1'x4' and 2'x4'*

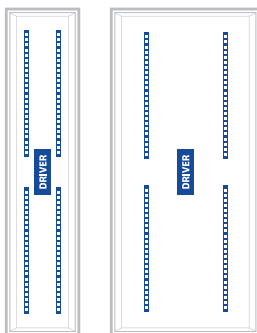
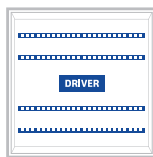

Recommended Strip Configurations

**NZLED<sup>®</sup> 9844-10**

*Inboard-Outboard configuration for 2'x2', 1'x4' and 2'x4'*

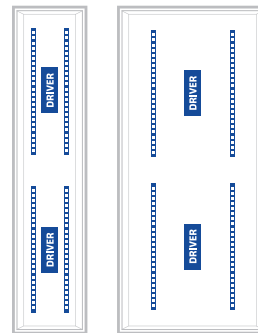
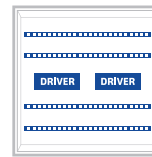

Recommended Strip Configurations



NZLED<sup>®</sup> 9822 pictured above.

**SERIES DIMENSIONS**

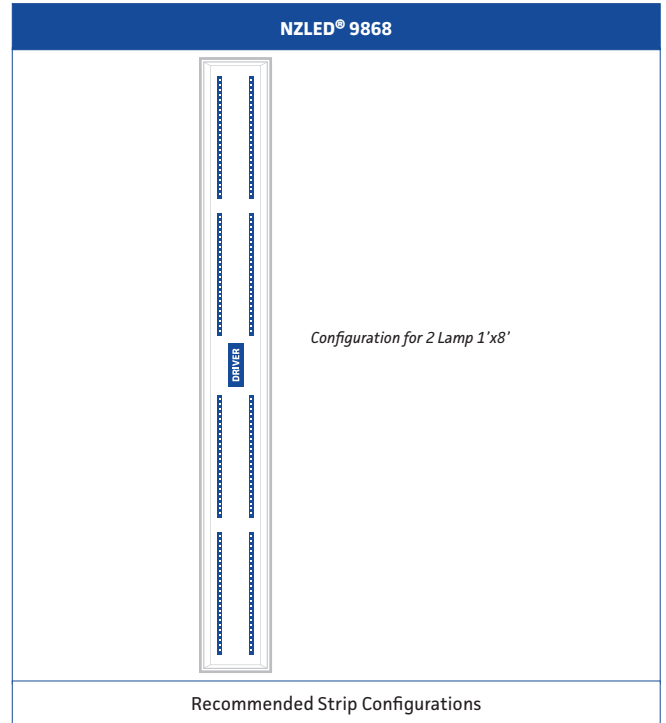
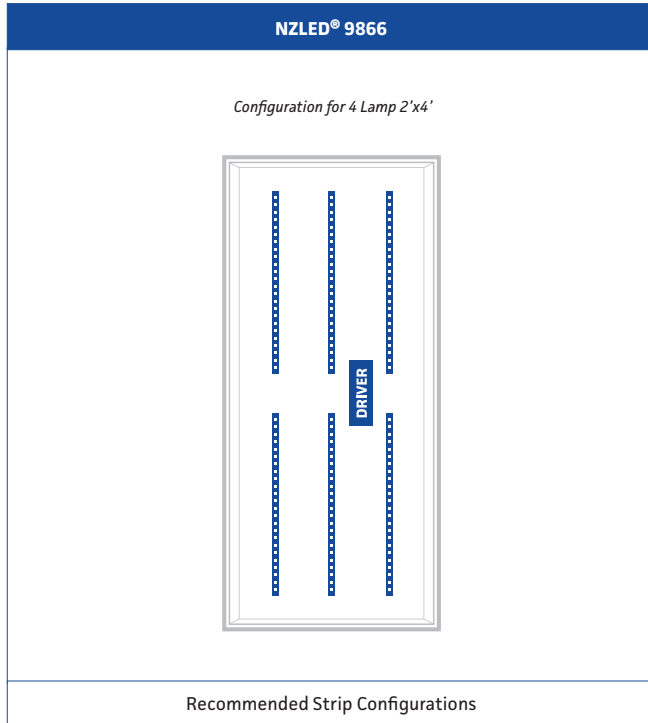



**INTERACTIVE MENU**

- Ordering Guide
- Product Availability Tables
- Photometric Data
- Dimensional Data

**PROJECT INFORMATION**

Project Name \_\_\_\_\_

Type \_\_\_\_\_

Catalog No. \_\_\_\_\_

Date \_\_\_\_\_

**FEATURES**

- Full distribution LED troffer
- Direct replacement of fluorescent 2x4
- Wet location option available
- Long-life, 60,000 hour LEDs at L80 reduce life cycle maintenance costs
- Four LED color choices and 80 CRI
- Many shielding choices
- Two door frame choices
- Metal to metal light leak protection on all four sides of shielding frame
- Fixed output, step dimming (high/low/off), 0-10V dimming, 0-10V dimming-dim to dark drivers available
- Hinged optical system allows easy access to LED modules and electrical from below the ceiling
- UL Sanitation certified per NSF standards
- All models standard with IC rating
- DLC® (DesignLights Consortium) Qualified, with some Premium Qualified configurations - see [www.designlights.org](http://www.designlights.org)
- Five year warranty)



**LJT24**

**CONSTRUCTION**

Luminaire housing, end caps, and reflectors are die-formed code-gauge cold-rolled steel. Optical system hinges from either side for easy access to LED module and electrical components. Mechanical light trap prevents light leaks.

**FINISH**

All metal parts processed with a multi-stage phosphate bonding treatment and finished with a high reflectance baked white enamel.

**SHIELDING**

Lens is high transmission pattern #12 acrylic (A12) for light diffusion without compromise to light output. Other shielding may be specified. If desired shielding media is not shown in ordering guide, contact your local Hubbell Lighting representative.

**INSTALLATION**

An access plate is furnished with each recessed fixture for fast wiring connections without the necessity to open the fixture or wireway.

**CEILING COMPATIBILITY**

Designed for recessed installation in standard inverted tee grid ceilings (G). Four integral T-bar clips standard. Also available for recessed installation in hard ceilings (G with FK accessory), surface mount at ceiling plane (SM), or cable mount suspension below ceiling plane (CM). For compatibility with specific ceilings contact your Hubbell Lighting representative.

**CERTIFICATION**

All luminaires are built to UL 1598 and 2108 standards, and bear appropriate CSA labels. UL Sanitation Certified per NSF Standards. Damp location labeling standard, wet location labeling is optional. CSA certified to UL 924 standards with battery pack or DTS (Dimming Bypass Module) options. Adheres to LM79, LM80 and TM21 industry standards. IC rating is standard on all models. DLC® (DesignLights Consortium) Qualified, with some Premium Qualified configurations. Please refer to the DLC website for specific product qualifications at [www.designlights.org](http://www.designlights.org). The DTS, Dimming Bypass Module, is for emergency circuit control loads including sensors and wireless systems CSA certified to UL 924. See page 6 for wiring diagram. [Link to Dimming Bypass Module Specification sheet.](#)

**WARRANTY**

Five year warranty. (Terms and Conditions Apply)

**ORDERING INFORMATION**

EXAMPLE LJT24-35MLG-FSA12-EU

YOUR ORDER **LJT24** - - -

LJT		24							
MODEL	SIZE	COLOR TEMP		LUMEN OUTPUT		CEILING TYPE		DOOR	
LJT LED Lensed Troffer	24 2' x 4'	30	3000K	XW	Extra Low Watt	G	Grid <sup>1</sup>	FS	White Flush Steel
		35	3500K	VW	Very Low Watt	SM	Surface Mount	FA	White Flush Aluminum
		40	4000K	MW	Medium Low Watt	CM	Cable Mount <sup>2</sup>	RA	Regressed Aluminum <sup>3</sup>
		50	5000K	LW	Low Watt				
				ML	Medium Lumen				
				HL	High Lumen				
				VL	Very High Lumen				
				XL	Extra High Lumen <sup>5</sup>				

See Product Availability Table Below

SHIELDING		DRIVER		VOLTAGE		OPTIONS	
A12	Pattern 12 Acrylic Lens	E	Fixed Output	U	120V-277V	ELL14	Emergency Battery Pack Installed, 1400 Lumens <sup>6,5</sup>
A12125	Pattern 12 Acrylic Lens, 0.125" Nominal	ED	0-10V Dimming	347	347V	C388	3-Wire Flex
A12F	Pattern 12 Frosted Acrylic Lens	ED1	0-10V 1% Dimming			C488	4-Wire Flex
A12125F	Pattern 12 Frosted Acrylic Lens, 0.125" Nominal	EDD	0-10V Dimming, Dim to Dark <sup>7</sup>			C588	5-Wire Flex
A19	Pattern 19 Acrylic Lens, 0.156" Nominal	ESD	Step Dimming <sup>4,5</sup>			GLR	Fast Blow Fuse
A19F	Pattern 19 Frosted Acrylic Lens 0.156"	LUTH	Hi-lume 1% EcoSystem LED driver with Soft-on, Fade-to-Black dimming technology <sup>4,5</sup>			GTD	Generator Transfer Device <sup>7</sup>
		LUT5	5-Series EcoSystem LED driver <sup>4,5</sup>			DTS	Dimming Bypass Module <sup>8</sup>
<b>ACCESSORIES (ORDER SEPARATELY)</b>							
FK24	2' x 4' Single Flange Kit					G1	Single Gasketing (Door to Housing)
CM48Y2SC3F-KIT	48" Cable Mount Kit for 2' wide CM ceiling type, 3 Wire Feed Cord					G2	Double Gasketing (G1 and Lens to Door)
						G3	Triple Gasketing (G2 and Housing to Ceiling)
						WL	Wet Location (Select G2 or G3 Gasketing) <sup>9</sup>
						EOR	End of Row (SM and CM only. Provides end wiring access for continuous row mounting.)
						INT	Intermediate (SM and CM only. Provides ends with wiring access for continuous row mounting.)
						CP	Chicago Plenum

<sup>1</sup> For hard ceilings use flange kit accessory  
<sup>2</sup> Order hanger accessories separately  
<sup>3</sup> Increases fixture depth to 4 3/4"  
<sup>4</sup> Not available in all lumen packages, see driver table below  
<sup>5</sup> Not available with 347V  
<sup>6</sup> For compatibility with Dual-Lite LiteGear® inverters in lieu of installed battery pack, contact Hubbell Lighting Representative  
<sup>7</sup> GTD available for E (fixed output) driver option only  
<sup>8</sup> For emergency circuit control loads including sensors and wireless systems CSA certified to UL 924. Only available with 0-10V drivers. Universal voltage only. See page 6 for wiring diagram  
<sup>9</sup> FA door and Grid Ceiling only

Damp label—standard  
 IC rating—standard

	XW	VW	MW	LW	ML	HL	VL	XL
E	X	X	X	X	X	X	X	X
ED	X	X	X	X	X	X	X	X
ED1	X	X	X	X	X	X	X	X
EDD	X	X	X	X	X	X	X	
ESD			X	X	X	X	X	
LUTH	X	X	X	X	X	X		
LUT5	X	X	X	X	X	X		

Product Availability			
Lumen Package	Lumens	Input Watts	LPW
LJT24-50XWG-FSA12-EU	2919	20	145
LJT24-40XWG-FSA12-EU	2681	20	133
LJT24-35XWG-FSA12-EU	2640	20	131
LJT24-30XWG-FSA12-EU	2563	20	127
LJT24-50VWG-FSA12-EU	3806	27	142
LJT24-40VWG-FSA12-EU	3495	27	130
LJT24-35VWG-FSA12-EU	3441	27	128
LJT24-30VWG-FSA12-EU	3341	27	125
LJT24-50MWG-FSA12-EU	4297	31	140
LJT24-40MWG-FSA12-EU	3946	31	129
LJT24-35MWG-FSA12-EU	3886	31	127
LJT24-30MWG-FSA12-EU	3772	31	123
LJT24-50LWG-FSA12-EU	4720	34	139
LJT24-40LWG-FSA12-EU	4334	34	127
LJT24-35LWG-FSA12-EU	4268	34	126
LJT24-30LWG-FSA12-EU	4144	34	122
LJT24-50MLG-FSA12-EU	5218	38	136
LJT24-40MLG-FSA12-EU	4792	38	125
LJT24-35MLG-FSA12-EU	4718	38	123
LJT24-30MLG-FSA12-EU	4581	38	119
LJT24-50HLG-FSA12-EU	6017	45	133
LJT24-40HLG-FSA12-EU	5526	45	122
LJT24-35HLG-FSA12-EU	5441	45	120
LJT24-30HLG-FSA12-EU	5286	45	117
LJT24-50VLG-FSA12-EU	8191	59	138
LJT24-40VLG-FSA12-EU	7522	59	127
LJT24-35VLG-FSA12-EU	7407	59	125
LJT24-30VLG-FSA12-EU	7192	59	121
LJT24-50XLG-FSA12-EU	9763	73	134
LJT24-40XLG-FSA12-EU	8966	73	123
LJT24-35XLG-FSA12-EU	8829	73	121
LJT24-30XLG-FSA12-EU	8571	73	117



**PHOTOMETRIC DATA**

Test 16399 Test Date 06/28/2016

**LUMINAIRE DATA**

Luminaire	LJT24-40LWG-FSA12-EU LJT LED, Lensed Troffer 2' X 4' LED with A12 pattern acrylic prism lens
Ballast	XI040C110V054B5T1
Ballast Factor	1.00
Lamp	LED
Fixture Lumens	4334
Watts	34.00
Mounting	Recessed
Shielding Angle	0° = 90 90° = 90
Spacing Criterion	0° = 1.19 90° = 1.19
Luminous Opening in feet	Length: 3.92 Width: 1.92 Height: 0.00

**ENERGY DATA**

Total Luminaire Efficiency	100.0%
Total Lumens per Watt	127
ANSI/IESNA RP-1-2004 Compliance	Noncompliant
Comparative Yearly Lighting Energy Cost per 1000 Lumens	\$1.89 based on 3000 hrs. and \$0.08 per KWH

**ZONAL LUMEN SUMMARY**

Zone	Lumens	%Lamp	%Fixt.
0-30	1456	33.6	33.6
0-40	2317	53.5	53.5
0-60	3680	84.9	84.9
0-90	4334	100.0	100.0
0-180	4334	100.0	100.0

**INDOOR CANDELA PLOT**

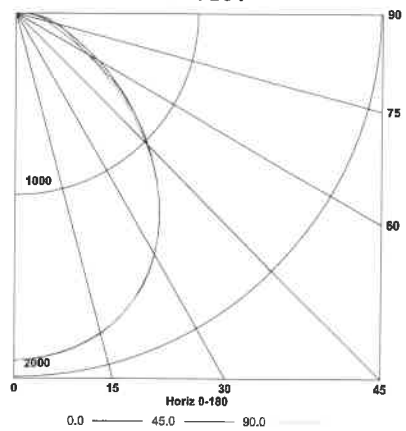

Test 16402 Test Date 06/27/2016

**LUMINAIRE DATA**

Luminaire	LJT24-40MLG-FSA12-EU LJT LED, Lensed Troffer 2' X 4' LED with A12 pattern acrylic prism lens
Ballast	XI040C110V054B5T1
Ballast Factor	1.00
Lamp	LED
Fixture Lumens	4792
Watts	38.40
Mounting	Recessed
Shielding Angle	0° = 90 90° = 90
Spacing Criterion	0° = 1.19 90° = 1.19
Luminous Opening in feet	Length: 3.81 Width: 1.80 Height: 0.00

**ENERGY DATA**

Total Luminaire Efficiency	100.0%
Total Lumens per Watt	125
ANSI/IESNA RP-1-2004 Compliance	Noncompliant
Comparative Yearly Lighting Energy Cost per 1000 Lumens	\$1.90 based on 3000 hrs. and \$0.08 per KWH

**ZONAL LUMEN SUMMARY**

Zone	Lumens	%Lamp	%Fixt.
0-30	1609	33.6	33.6
0-40	2562	53.5	53.5
0-60	4069	84.9	84.9
0-90	4792	100.0	100.0
0-180	4792	100.0	100.0

**INDOOR CANDELA PLOT**

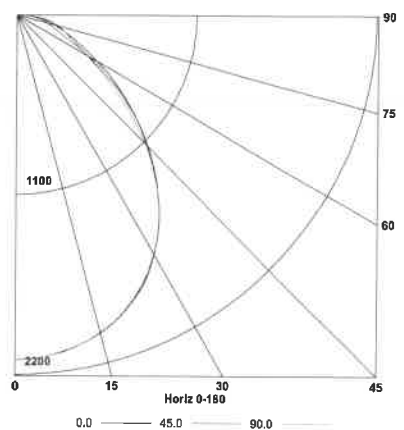

Test 16405 Test Date 06/28/2016

**LUMINAIRE DATA**

Luminaire	LJT24-40HLG-FSA12-EU LJT LED, Lensed Troffer 2' X 4' LED with A12 pattern acrylic prism lens
Ballast	XI054C150V054B5T1
Ballast Factor	1.00
Lamp	LED
Fixture Lumens	5526
Watts	45.20
Mounting	Recessed
Shielding Angle	0° = 90 90° = 90
Spacing Criterion	0° = 1.18 90° = 1.18
Luminous Opening in feet	Length: 3.81 Width: 1.80 Height: 0.00

**ENERGY DATA**

Total Luminaire Efficiency	100.0%
Total Lumens per Watt	122
ANSI/IESNA RP-1-2004 Compliance	Noncompliant
Comparative Yearly Lighting Energy Cost per 1000 Lumens	\$1.95 based on 3000 hrs. and \$0.08 per KWH

**ZONAL LUMEN SUMMARY**

Zone	Lumens	%Lamp	%Fixt.
0-30	1870	33.8	33.8
0-40	2975	53.8	53.8
0-60	4704	85.1	85.1
0-90	5526	100.0	100.0
0-180	5526	100.0	100.0

**INDOOR CANDELA PLOT**

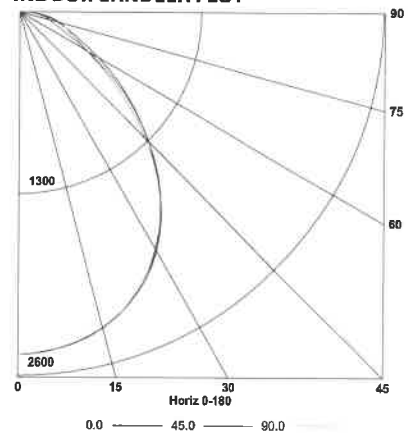

**DIMENSIONAL DATA**

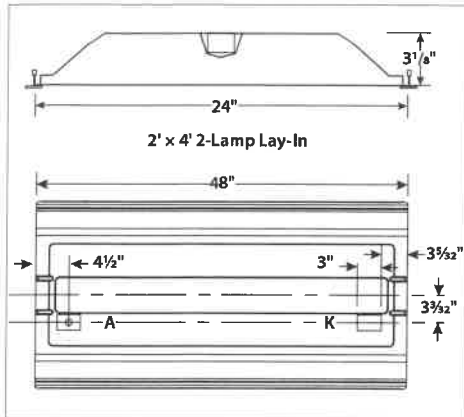

A: 7/8" Diameter knockout  
K: 2" x 3" through hole for access plate.

**NOTE:** All dimensions are in inches; dimensions and specifications are subject to change without notice. Please consult factory or check sample for verification.

**CEILING COMPATIBILITY**

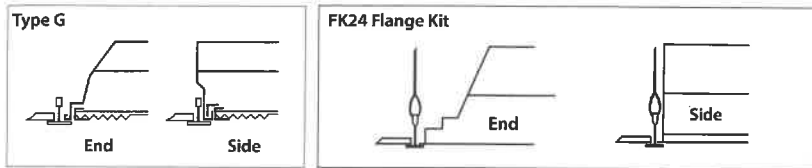

For lay-in installation in exposed grid ceilings. Maximum tee widths of 1" and maximum tee heights of 2" allowed.

For hard ceiling applications order FK24 flange kit. Flange kit wires directly into concealed ceiling opening for a clean, finished appearance.

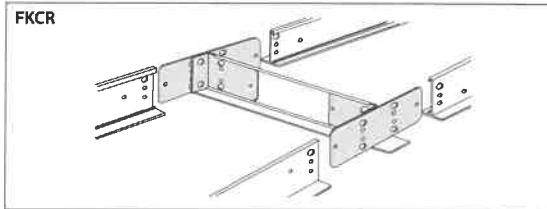

For flanged fixtures in row configurations, the FKCR adapter bracket kit is required in addition to the FK24 kit. Order one less FKCR than the total number of fixtures in row. (Example: Row of two, order (2) FK24 & (1) FKCR)

Rough cut out dimensions using FK24 & FKCR adapters:  
Width 24 3/8", Length [48" x (# in row)] + 3/8". Example: (48" x 2) + 3/8" = 96 3/8"

Flange kit rough in dimensions for single unit only: 24 3/8" x 48 3/8"

**DIMENSIONAL DATA - SURFACE MOUNT (SM) AND CABLE MOUNT (CM)**

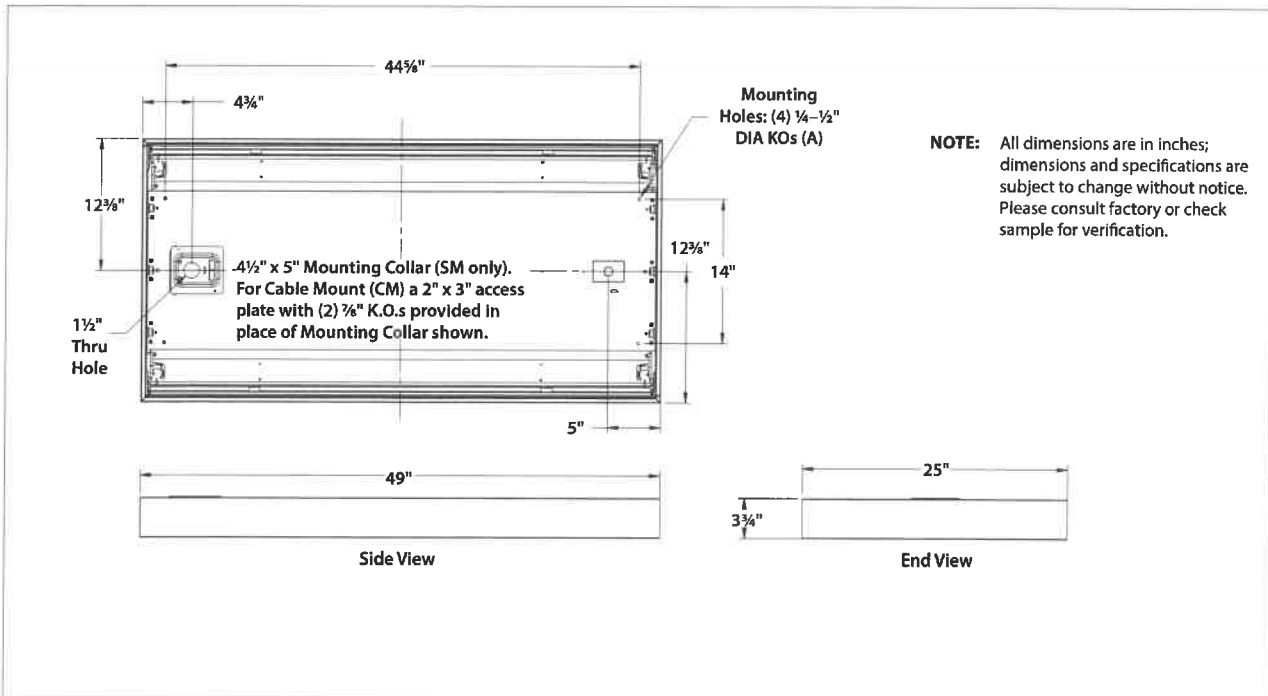

**NOTE:** All dimensions are in inches; dimensions and specifications are subject to change without notice. Please consult factory or check sample for verification.

**SURFACE MOUNT**

Order SM ceiling type. Mounting collar required for surface mounting. (4) Mounting knock-outs, 1/4" to 1/2" provided as shown, marked "A".

**CABLE MOUNT**

Order CM ceiling type. Access plate supplied for cable mounting or suspension. Use CM48Y2C3F-KIT 48" cable mount kit. Includes 3 wire feed cord. For other wiring needs, contact Hubbell Lighting representative. Mounting knock-outs, 1/4" to 1/2", provided as shown, marked "A".

**DTS WIRING DIAGRAM (0-10V DIMMING DRIVER SHOWN)**

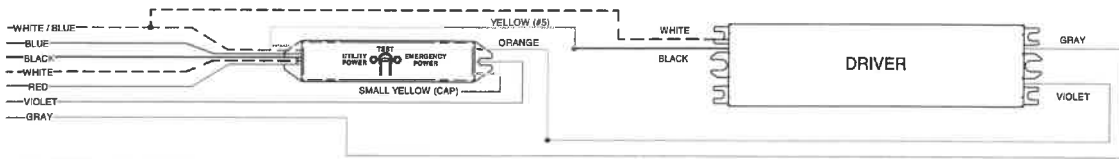

<b>WHITE/BLUE</b>	Emergency Neutral
<b>BLUE</b>	Emergency Line
<b>BLACK</b>	Utility Line_Unswitched Hot
<b>WHITE</b>	Utility Neutral
<b>RED</b>	Switched Hot
<b>VIOLET</b>	Dimming
<b>GRAY</b>	Dimming

DTS Integration Guide



## ST. JOHNS COUNTY SCHOOL DISTRICT

Sebastian Administrative Annex

Purchasing Department

3015 Lewis Speedway, Building 5

St. Augustine, Florida 32084

Telephone (904) 547-8941 FAX (904) 547-8945

*Patrick Snodgrass, CPSM  
Director of Purchasing*

July 1, 2020

TO ALL VENDORS:

The purpose of this letter is to serve as **ADDENDUM #1** to Bid #2020-19 Lighting Retrofit

**The Bid Sheet has been revised and is attached. A REVISED BID SHEET must be used for all submittals.**

The following is a list of questions that were asked along with the responses:

1. **Question:** I would like to know if there are any MWBE goals for this project.  
**Answer:** No, there are not any MWBE goals for this bid.
2. **Question:** are you planning to retrofit and install new fixtures?  
**Answer:** Yes, retrofit and install new fixtures when appropriate.
3. **Question:** are the current 2X2's U-Bent or F17T8?  
**Answer:** There is a mixture of both.
4. **Question:** what color temperature do you desire?  
**Answer:** As per specified in Attachment A of the bid specification.
5. **Question:** what lumen output are you looking to achieve for both the 2X2 and 2X4?  
**Answer:** As per specified in Attachment A of the bid specification.
6. **Question:** any idea on volume of fixtures being removed?  
**Answer:** Anticipated volume unknown at this time.
7. **Question:** are flat panels a considered for NEW installations?

**Answer:** Flat panel LED's could be considered at some locations.

8. **Question:** On the first and third line, the 2'x2' retrofit kit. In the past, practically we have put in 1/2 of a 9844IO kit which officially is a 9822 which is actually 2 of the 20 watt kits combined and this works for the 2x2 and the 1x4 as these are the ones we use 2 strips on (4 strips and the regular NZLED 9844-40 watt kit is used only on the 2'x4' fixtures). If you agree, my suggestion would be to change it to read:

**Line 1:**

**Purchase and Deliver of a Net Zero 20-Watt Retrofit Kit NZLED 9822 for a 2'x2' and / or 1'x4' Unit**

**Line 3:**

**Purchase, Deliver and Turnkey Installation for a Net Zero 20-Watt Retrofit Kit NZLED 9822 for a 2'x2' and / or 1'x4' Unit**

**Answer:** See Revised Bid Sheet.

9. **Question:** On line 9, Percentage (%) Markup Over Costs for Additional Parts and Materials. Four years ago there was confusion that this is for other LED lights not specifically listed in the bid and also for misc parts and materials which should be priced differently. To eliminate this confusion, would it be possible to keep this line item as is and then add another line item for:

**"Other LED and related Products and Services Percentage (%) Markup above costs not specifically identified in this bid"**

**Answer:** See Revised Bid Sheet.

10. **Question:** On line 10 and 11, you only have product only pricing for the alternatives for the NZLED 9844 and the Columbia Lighting LJT24. **Should you not also have a line item for the alternate of the breakout as above (for the 9844 and the 9822) for product only and turnkey and then on the Columbia Lighting LJT24, product only and turnkey as well?**

See the attachment for specific line references in the above questions.

Line		Price
①	Purchase and Delivery of Net Zero 40-Watt Retrofit Kit NZLED 9844 for a 2'x2' Unit	\$
	Purchase and Delivery of Net Zero 40-Watt Retrofit Kit NZLED 9844 for a 2'x4' Unit	\$
③	Purchase, Delivery and Turnkey Installation for Net Zero 40 Watt Retrofit Kit NZLED 9844 for a 2' x 2' Unit	\$
	Purchase, Delivery and Turnkey Installation for Net Zero 40 Watt Retrofit Kit NZLED 9844 for a 2' x 4' Unit	\$
	Purchase and Delivery of Columbia Lighting LJT24 2'x4' LED Troffer Kit	\$
	Purchase, Delivery and Turnkey Installation for Columbia Lighting LJT24 2'x4' LED Troffer Kit	
	Hourly Labor Rate for Additional Work - Journeyman	\$ Per Hour
	Hourly Labor Rate for Additional Work - Helper	\$ Per Hour
⑨	Percentage (%) Markup Over Cost for Additional Parts and Materials	%
⑩	If applicable, bidder must list alternate ("or equal") product to Net Zero 40-Watt Retrofit Kit NZLED 9844	
⑪	If applicable, bidder must list alternate ("or equal") product to Columbia Lighting LJT24 2'x4' LED Troffer Kit	

**Answer:** See Revised Bid Sheet.

11. **Question:** Is the only acceptable means of payment a ghost visa card like before, no check or ACH payments will be made?

**Answer:** As stated in Section 11.0 Contractor Payment, the St. Johns County School District requires all Contractors responding to this bid to accept payment from SJCSD on a Visa credit card. No other payment options will be made available.

12. **Question:** are you planning to retrofit and install new fixtures?

**Answer:** See response #2.

13. **Question:** are the current 2X2's U-Bent or F17T8?

**Answer:** See response #3.

14. **Question:** what color temperature do you desire?

**Answer:** See response #4.

15. **Question:** what lumen output are you looking to achieve for both the 2X2 and 2X4?

**Answer:** See response #5.

16. **Question:** any idea on volume of fixtures being removed?

**Answer:** See response #6.

17. **Question:** are flat panels a considered for NEW installations?

**Answer:** See response #7.

Thank you for your continued participation in the bid process.

Sincerely,

A handwritten signature in black ink, appearing to read "Patrick Snodgrass". The signature is written in a cursive, flowing style.

Patrick Snodgrass  
Director of Purchasing

	If Alternate Product Is Being Offered List Manufacturer and Model	Price
Purchase and Delivery of Net Zero 40-Watt Retrofit Kit NZLED 9844 for a 2'x2' Unit		\$
Purchase and Delivery of Net Zero 40-Watt Retrofit Kit NZLED 9844 for a 2'x4' Unit		\$
Purchase, Delivery and Turnkey Installation for Net Zero 40 Watt Retrofit Kit NZLED 9844 for a 2'x2' Unit		\$
Purchase, Delivery and Turnkey Installation for Net Zero 40 Watt Retrofit Kit NZLED 9844 for a 2'x4' Unit		\$
Purchase and Delivery of Net Zero 20-Watt Retrofit Kit NZLED 9822 for a 2'x2' Unit		\$
Purchase and Delivery of Net Zero 20-Watt Retrofit Kit NZLED 9822 for a 1'x4' Unit		\$
Purchase, Delivery and Turnkey Installation for Net Zero 20 Watt Retrofit Kit NZLED 9822 for a 2'x2' Unit		\$
Purchase, Delivery and Turnkey Installation for Net Zero 20 Watt Retrofit Kit NZLED 9822 for a 1'x4' Unit		\$
Purchase and Delivery of Columbia Lighting LJT24 2'x4' LED Troffer Kit		\$
Purchase, Delivery and Turnkey Installation for Columbia Lighting LJT24 2'x4' LED Troffer Kit		\$
Hourly Labor Rate for Additional Work - Journeyman		\$ Per Hour
Hourly Labor Rate for Additional Work - Helper		\$ Per Hour
Percentage (%) Markup Over Cost for Other LED and related Products.		%
Percentage (%) Markup Over Cost for Other Non LED and related products.		%

**Vendor Acknowledgement and Approval**

I certify that this bid is made without prior understanding, agreement or connection with any corporation, firm or person submitting a bid for the same materials, supplies, equipment or services, and in all respects fair and without collusion or fraud. The following information, including an authorized representative signature, is required to be submitted with your bid in order to be considered for evaluation and award. The person signing below acknowledges and agrees with all proposed information as submitted and has the authorization of the said company to enter into a contractual agreement with the St. Johns County School District for the purposes as proposed and described herein.

Company Name: \_\_\_\_\_

Authorized Signature: \_\_\_\_\_

Print Name: \_\_\_\_\_

Date: \_\_\_\_\_