

St. Johns County School District
Sebastian Administrative Annex
Purchasing Department
3015 Lewis Speedway, Unit 5
St. Augustine, FL 32084



INVITATION TO BID (ITB)

REQUIRED RESPONSE FORM

BID NO.: 2017-03
RELEASE DATE: January 11, 2017
NON MANDATORY MEETING. SEE BID DOC.

INVITATION TO BID TITLE:
Pavement Rehabilitation

F.O.B. Destination: **District Wide**

CONTACT: Patrick Snodgrass
Director of Purchasing
(904) 547-8941
patrick.snodgrass@stjohns.k12.fl.us

BID DUE DATE AND TIME: February 13, 2017 @ 1:30 pm
BID OPENING DATE AND TIME: February 13, 2017 @ 2:00 pm

SUBMIT BID TO: Sebastian Administrative Annex
Purchasing Department
3015 Lewis Speedway, Unit 5
St. Augustine, FL 32084

BID OPENING LOCATION: Sebastian Administrative Annex
Purchasing Department
3015 Lewis Speedway, Unit 5
St. Augustine, FL 32084

REQUIRED SUBMITTALS CHECKLIST - Each submittal checked below is **required** for Bid to be considered.

- Literature Specifications Catalogs Product Samples: See Special Conditions
 Debarment Form Manufacturer's Certificate of Warranty
 Drug-Free Workplace Certification List of References
 Certificate of Insurance: See Special Conditions
 Additional submittals specific to this ITB may also be required – See Special Conditions for details

BIDDER MUST FILL IN THE INFORMATION LISTED BELOW AND SIGN WHERE INDICATED FOR BID TO BE CONSIDERED.

Company Name: _____

Address: _____

City, State: _____ Zip: _____ FEIN: _____

Signature of Owner or Authorized Officer/Agent _____ Telephone: _____

Typed Name of Above: _____ FAX: _____

Email: _____

By my signature, I certify that this offer is made without prior understanding, agreement, or connection with any corporation, firm, business entity or person submitting an offer for the same materials, supplies, equipment, or services (s), and is in all respects fair and without collusion or fraud. I further agree to abide by all conditions of this invitation and certify that I am authorized by the offeror to sign this response. In submitting an offer to the School Board of St. Johns County, I, as the Bidder, offer and agree that if the offer is accepted, the offeror will convey, sell, assign, or transfer to the School Board of St. Johns County all right, title, and interest in and to all causes of action it may now or hereafter acquire under the Anti-trust laws of the United States and the State of Florida for price fixing relating to the particular commodity(s) or service(s) purchased or acquired by the School Board. At the School Board's discretion, such assignment shall be made and become effective at the time the School Board of St. Johns County tenders final payment to the vendor.

GENERAL CONDITIONS, INSTRUCTIONS AND INFORMATION

Bidder: To ensure acceptance of the bid follow these instructions:

1. **DEFINITIONS:** For purpose of these General Conditions "ITB" refers to the Invitation to Bid. "Bid" refers to the completed ITB Required Response Form above, together with all supporting documentations and submittals. "Bidder" refers to the entity or person that submits the Bid. "District" refers to the St. Johns County School District, and "School Board" to the St. Johns County School Board. "Purchasing Department Representative" refers to the Purchasing Department staff member named as its contact on the first page of the ITB. "Conditions" refers to both the General Conditions and the Special Conditions of this ITB.
2. **EXECUTION OF BID:** The ITB Required Response Form must be completed, signed, and returned in a sealed envelope to the Purchasing Department, together with the Bid and all required submittals. All Bids must be completed in ink or typewritten. If a correction is necessary, draw a single line through the entered figure and enter the corrected figure or use an opaque correction fluid. All corrections should be initialed by the person signing the Bid even when using opaque correction fluid. Any illegible entries will not be considered for award. The ITB General Conditions, Special Conditions and specifications **cannot** be changed or altered in any way by the Bid or otherwise by the Bidder. In the event of any conflict between the Conditions and specifications of the ITB and the terms and conditions of the Bid, the Conditions and specifications of the ITB take precedence. Any failure to comply with the ITB Conditions or specifications or attempt to alter them by the Bidder shall be grounds for rejection of the Bid.
3. **SUBMISSION OF BID:** The completed Bid must be submitted in a sealed envelope with the ITB title and bid number on the outside. Bids must be time stamped by the Purchasing Department prior to the ITB due time on date due. No Bid will be considered if not time stamped by the Purchasing Department prior to the stated submission deadline. Bids submitted by telegraphic or facsimile transmission will not be accepted unless authorized by the Special Conditions of this ITB.
4. **SPECIAL CONDITIONS:** The Purchasing Department has the authority to issue Special Conditions as required for a particular ITB. Any Special Conditions that vary from these General Conditions shall take precedence over the General Conditions.
5. **PRICES QUOTED:** Deduct trade discounts and quote a firm net price. Give both unit price and aggregate total. Prices must be stated in units to quantity specified in the ITB. In case of discrepancy in computing the amount of the Bid, the **Unit Price** quoted will govern. All prices quoted shall be F.O.B. destination, freight prepaid. Bidder is responsible for freight charges. Bidder owns goods in transit and files any claims, unless otherwise stated in Special Conditions. Each item must be proposed separately and no attempt is to be made to tie any item or items in with any other item or items. If a Bidder offers a discount or offers terms less than Net 30, it is understood that a minimum of thirty (30) days will be required for payment. If a payment discount is offered, the discount time will be computed from the date of satisfactory delivery at place of acceptance and receipt of correct invoice at the office specified.
 - a) Taxes: The School Board does not pay Federal excise and State taxes on direct purchase of tangible personal property. The applicable tax exemption number is shown on the purchase order. This exemption does not apply to purchases of tangible personal property made by contractors who use the tangible personal property in the performance of contracts for the improvement of School Board-owned real property as defined in Chapter 192 of the Florida Statutes.
 - b) Mistakes: Bidders are expected to examine the General and Special Conditions, specifications, delivery schedules, Bid prices and extensions, and all instructions pertaining to supplies and services. Failure to do so will be at Bidder's risk.

- c) **Conditions and Packaging:** It is understood and agreed that any item offered or shipped as a result of this ITB shall be new (current production model at the time of this ITB) unless otherwise stated. All containers shall be suitable for storage or shipment, and all prices shall include standard commercial packaging.
- d) **Underwriters' Laboratories:** Unless otherwise stipulated in the ITB, all manufactured items and fabricated assemblies shall be U.L. listed where such has been established by U.L. for the item(s) offered and furnished. In lieu of the U.L. listing, Bidder may substitute a listing by an independent testing laboratory recognized by OSHA under the Nationally Recognized Testing Laboratories (NRTL) Recognition Program.
- e) **Preference for St. Johns County Bidders:** For all purchases made by the School Board, prices and quality being equal, preference may be given to St. Johns County Bidders, subject to certification as a drug-free workplace (Florida Statutes 287.087 and 287.084).
- 6. BRAND NAMES:** The District reserves the right to invite Bids for a particular product or specific equipment by manufacturer, make, model or other identifying information. However, a Bidder may propose a substitute product of equal quality and functionality unless the Conditions or specifications state that substitute products or equipment may not be proposed and will not be considered. If a substitute product is proposed, it is the Bidder's responsibility to submit with the Bid brochures, samples and/or detailed specifications on the substitute product. The District shall be the sole judge in the exercise of its discretion for determining whether the substitute product is equal and acceptable.
- 7. QUALITY:** The items proposed must be new and equal to or exceed specifications. The manufacturer's standard warranty shall apply. During the warranty period, the successful Bidder must repair and/or replace the unit without cost to the District with the understanding that all replacements shall carry the same warranty as the original equipment. The successful Bidder shall make any such repairs and/or replacements immediately upon receiving notice from the District.
- 8. SAMPLES:** Samples of items, when required, must be furnished free of expense by the ITB due date unless otherwise stated. If not destroyed, upon request, samples will be returned at the Bidder's expense. Bidders will be responsible for the removal of all samples furnished within thirty (30) days after ITB opening. All samples will be disposed of after thirty (30) days. Each individual sample must be labeled with Bidder's name, ITB number, and item number. Failure of Bidder to either deliver required samples or to clearly identify samples as indicated may be reason for rejection of the ITB. Unless otherwise indicated, samples should be delivered to the office of the Purchasing Department of the St. Johns County School Board, Sebastian Administrative Annex, 3015 Lewis Speedway Unit 5, St. Augustine, FL 32084.
- 9. TESTING:** Items proposed may be tested for compliance with ITB Conditions and specifications.
- 10. NON-CONFORMITY:** Items delivered that do not conform to ITB Conditions or specifications may be rejected and returned at Bidder's expense. Goods or services not delivered as per delivery date in ITB and/or purchase order may be purchased on the open market. The Bidder shall be responsible for any additional cost. Any violation of these stipulations may also result in Bidder being disqualified from participating in future competitive solicitations or otherwise doing business with the District.
- 11. DELIVERY:** Unless actual date of delivery is specified (or if specified delivery cannot be met), the Bid must show the number of days required to make delivery after receipt of purchase order in space provided. Delivery time may become a basis for recommending an award (see Special Conditions).
- 12. REQUESTS FOR CLARIFICATION:** No correction or clarification of any ambiguity, inconsistency or error in the ITB Conditions and specifications will be made to any Bidder orally. Any request for such interpretation or correction should be by email addressed to the Purchasing Department Representative prior to the deadline specified in the Special Conditions for submitting questions. All such interpretations and supplemental instructions will be in the form of written

addenda to the ITB. Only the interpretation or correction so given by the Purchasing Department Representative, by email or in writing, shall be binding and prospective Bidders are advised that no other source is authorized to give information concerning, or to explain or interpret the ITB Conditions and specifications.

- 13. DISPUTE:** Any dispute concerning the Conditions or specifications of this ITB or the contract resulting from this ITB shall be decided by Purchasing Department and that decision shall be final.
- 14. AWARDS:** Bids shall be reviewed in accordance with the ITB Conditions and specifications and the best interest of the School District. To that end, the Board reserves the right to reject any and all Bids; to waive any irregularities or informalities; to accept any item or group of items; to request additional information or clarification from any Bid; to acquire additional quantities at prices quoted in the Bid unless additional quantities are not acceptable, in which case the Bid must be conspicuously labelled "BID IS FOR SPECIFIED QUANTITY ONLY", and to purchase the product or service at the price and terms of any contract with a governmental entity procured by competitive solicitation, in accordance with Florida law. The decision to award a contract or take other action in regard to the ITB shall be made in the best interest of the School District.
- 15. OTHER GOVERNMENTAL AGENCIES:** It is the intent of this solicitation to obtain Bids to sell the services or products to the School Board. Other school boards and governmental agencies/entities may purchase goods or services based on the contract awarded as a result of this ITB. The services and products are to be furnished in accordance with the terms of the resulting contract.
- 16. MARKING:** A packing list must be included in each shipment and shall show the School Board purchase order number, ITB number, school name or department name, contents and shipper's name and address; mark packing list and invoice covering final shipment "Order Completed". If no packing list accompanies the shipment, the buyer's count will be accepted. Mark each package clearly with (A) shipper's name and address, (B) contents, (C) the School Board of St. Johns County purchase order number, and (D) ITB number.
- 17. INSPECTION, ACCEPTANCE & TITLE:** Inspection and acceptance will be at destination shown on purchase order unless otherwise provided. Title to/or risk of loss or damage to all items shall be the responsibility of the successful Bidder until acceptance by the District. If the materials or services supplied to the District are found to be defective or do not conform to specifications, the Board reserves the right to cancel the order upon written notice to the Bidder and return product at Bidder's expense.
- 18. BILLING AND PAYMENT:** Invoices, unless otherwise indicated, must show purchase order numbers and shall be submitted to St. Johns County School District, Accounts Payable Department, 40 Orange Street, St. Augustine, FL 32084. Payment will be made as prescribed in the Special Conditions and properly invoiced.
- 19. COPYRIGHT AND PATENT RIGHTS:** The Bidder, without exception, shall indemnify and hold harmless the School Board and its employees from liability of any nature or kind, including legal fees and other costs and expenses, for or on account of any copyrighted, patented, or unpatented invention, process, or article manufactured or used in the performance of the contract, including its use by the School Board. If the Bidder uses any design, device, or materials covered by letters, patent, or copyright, it is mutually understood and agreed without exception that the Bid prices shall include all royalties or cost arising from the use of such design, device or materials in any way involved in the work.
- 20. OSHA:** The Bidder warrants that the product supplied to the School Board shall conform in all respects to the standards set forth in the Occupational Safety and Health Act of 1970, as amended, and the failure to comply with this condition will constitute a breach of contract.
- 21. LEGAL REQUIREMENTS:** The Bidder shall comply with Federal, State, County, and local laws, ordinances, rules, and regulations that in any manner affect the items covered herein. Lack of knowledge by the Bidder will in no way be a cause for relief from responsibility.

- 22. CONFLICT OF INTEREST:** The award hereunder is subject to the provisions of Chapter 112, Florida Statutes. All Bidders must disclose with their Bid the name of any officer, director, or agent who is also an employee of the School Board. Further, all Bidders must disclose the name of any Board employee who owns directly or indirectly, an interest of five percent (5%) or more of the total assets of capital stock in the Bidder's firm.
- 23. ANTI-DISCRIMINATION:** The Bidder certifies that Bidder is in compliance with the requirements of law regarding equal employment opportunity for all persons without regard to age, race, color, religion, sex, national origin, or disability.
- 24. LICENSES AND PERMITS:** The Bidder shall be responsible for obtaining, at its expense, all licenses and permits required for performance of the work or services resulting from the ITB award.
- 25. BID BONDS, PERFORMANCE BONDS, CERTIFICATES OF INSURANCE:** Bid bonds, when required, shall be submitted with the Bid in the amount specified in Special Conditions. Bid bonds will be returned to unsuccessful Bidders. After acceptance of Bid, the Board will notify the successful Bidder to submit a performance bond and certificate of insurance in the amount specified in Special Conditions. St. Johns County School District shall be named as additional insured on policies required by detailed specifications. Upon receipt of the performance bond, the Bid bond will be returned to the successful Bidder.
- 26. DEFAULT AND REMEDIES:** The following remedies for default shall apply.
- a) **Failure to Timely Deliver.** The parties acknowledge and agree that the damages for the failure of the successful Bidder to timely deliver the products or services contracted for may be difficult to determine. Moreover, both parties wish to avoid lengthy delay and expensive litigation relating to the failure of the successful Bidder to deliver on time. Therefore, in the event the successful Bidder fails to timely deliver the products or services contracted for, the School Board may exercise the remedy of liquidated damages against the successful Bidder in an amount equal to 25% of the unit price Bid, times the quantity. The successful Bidder shall pay that sum to the School Board not as a penalty, but as liquidated damages intended to compensate for unknown and unascertainable damages.
- b) **Other Default.** In the event of default for any reason other than the failure of the successful Bidder to timely deliver the products or services contracted for, the School Board may exercise any and all remedies in contract or tort available to it, including, but not limited to, the recovery of actual and consequential damages.
- 27. TERMINATION:** In the event any of the provisions of this ITB are violated by the Bidder, the Purchasing Department reserves the right to reject its Bid. Furthermore, the School Board reserves the right to terminate any contract resulting from this ITB for financial or administrative convenience, as determined in its sole business judgment, upon giving thirty (30) days prior written notice to the other party.
- 28. FACILITIES:** The Board reserves the right to inspect the Bidder's facilities at any time with prior notice.
- 29. ASBESTOS STATEMENT:** All material supplied to the School Board must be 100% asbestos free. Bidder by virtue of proposing, certifies by signing Bid, that if awarded any portion of this Bid, will supply only material or equipment that is 100% asbestos free.
- 30. INDEMNITY AND HOLD HARMLESS AGREEMENT:** During the term of this Bid and any contract awarded to Bidder as a result of this ITB, the Bidder shall indemnify, hold harmless, and defend the School Board, its agents, and employees from any and all costs and expenses, including but not limited to, attorney's fees, reasonable investigative and recovery costs, court costs and all other sums which the Board, its agents, servants and employees, may pay or become obligated to pay on account of any, all and every claim or demand, or assertion of liability, or any claim or actions founded, thereon, arising or alleged to have arisen out of the products, goods or services furnished

by the Bidder, its agents, or employees, or any of its equipment, including, without limitation, claims for damages, injury to person or property, including the Board's property, or death.

31. CRIMINAL BACKGROUND SCREENING: Pursuant to Florida Statute 1012.467 and School Board Rule 7.142, the District will issue and recognize statewide background badges to non-instructional contractor employees who meet the clearance requirements of Florida Statute 1012.467(2)(g) when it is not anticipated that they will come into direct contact with students. However, pursuant to Florida Statute 1012.467 and School Board Rule 7.142, if the District is unable to rule out that Bidder's employees or subcontractors may come into contact with students, then, in the paramount interest of student safety, the employees will be required to undergo and pass background screening in accordance with School Board Rule 7.142, unless another statutory exemption applies.

For this ITB:

- A. Student contact not anticipated
- B. Student contact anticipated

If Box A is checked, statewide badge will be recognized or issued, if requested and the contractor meets clearance requirements.

If Box B is checked, background screening pursuant to School Board Rule 7.142(4) will be required.

The Bidder acknowledges and agrees to comply with the requirements of School Board Rule 7.142. Bidder shall be responsible for the expense of the background screening of its employees.

32. VENUE: Any suit, action, or other legal proceedings arising out of or relating to any contract awarded based upon this ITB shall be brought in a court of competent jurisdiction in St. Johns County, Florida. The parties waive any right to require that a suit, action, or proceeding arising out of this Agreement be brought in any other jurisdiction or venue.

33. WAIVER OF JURY TRIAL: The parties knowingly, voluntarily, and intentionally waive their right to trial by jury with respect to any litigation arising out of, under, or in connection with this ITB or any contract awarded upon this ITB. This provision is a material inducement for the School Board to enter into a contract with the successful Bidder.

34. LOBBYING: Lobbying is not permitted with any District personnel or School Board members in connection with any ITB or competitive solicitation. All oral or written inquiries must be directed through the Purchasing Department. Lobbying is defined as any action taken by an individual, firm, association, joint venture, partnership, syndicate, corporation, and all other groups who seek to influence the governmental decision of a board member or district personnel on the award of this contract. Any Bidder or any individuals that lobby on behalf of Bidder will result in rejection/disqualification of said Bid.

35. ASSIGNMENTS: The successful bidder may not sell, assign or transfer any of its rights, duties or obligations under Bid contract without the prior written consent of the School Board.

36. PROTEST: Failure to give notice or file a protest within the time prescribed in Section 120.57 (3), Florida Statutes, shall constitute a waiver of any protest.

37. COMPLIANCE WITH FEDERAL REGULATIONS: All contracts involving Federal funds will contain certain provisions required by applicable sections of Title 34, Section 80.36(l) and 85.510, Code of Federal Regulations and are included by reference herein.

- a) Debarment: The Bidder certifies by signing the Bid and required response form that the Bidder and its principals are not presently debarred, suspended, proposed for debarment, declared ineligible or voluntarily excluded from participation in Federally funded transactions and may, in certain instances, be required to provide a separate written certification to this effect.

During the term of any contract with the School Board, in the event of debarment, suspension, proposed debarment, declared ineligible or voluntarily excluded from participation in Federally funded transactions, the Bidder shall immediately notify the Purchasing Department and the Superintendent, in writing.

- b) Records: Vendors will also be required to provide access to records, which are directly pertinent to the contract and retain all required records for three (3) years after the School Board's final **payment is made**.
- c) Termination: For all contracts involving Federal funds, in excess of \$10,000, the School Board reserves the right to terminate the contract for cause as well as convenience by issuing a certified notice to the vendor.

38. PUBLIC ENTITY CRIME: Pursuant to Florida Statute 287.133, a person or affiliate who has been placed on the convicted vendor list following a conviction for a public entity crime may not submit a Bid on a contract to provide any goods or services to a public entity, may not submit a Bid on a contract with a public entity for the construction or repair of a public building or public work, may not submit Bids on leases of real property to a public entity, may not be awarded or perform work as a contractor, supplier, subcontractor, or consultant under a contract with any public entity, and may not transact business with any public entity in excess of the threshold amount provided in Section 287.017 of Florida Statute, for CATEGORY TWO for a period of thirty-six (36) months from the date of being placed on the convicted vendor list.

39. COLLECTION, USE OR RELEASE OF SOCIAL SECURITY NUMBERS: The St. Johns County School District is authorized to collect, use or release social security numbers (SSN) of vendors, contractors and their employees and for the following purposes, which are noted as either required or authorized by law to be collected. The collection of social security numbers is either specifically authorized by law or imperative for the performance of the District's duties and responsibilities as prescribed by law (Sections 119.07(5)(a)2 and 3, Florida Statutes):

- a) **Criminal history and criminal background checks/Identifiers for processing fingerprints by Department of Law Enforcement/, if SSN is available** [Required by Fla. Admin. Code 11 C-6.003 and Fla. Stat. § 119.07(5)(a)6]
- b) **Vendors/Consultants that District reasonably believes would receive a 1099 form if a tax identification number is not provided including for IRS form W-9** [Required by 26 C.F.R. § 31.3406-0, 26 C.F.R. § 301.6109-1, and Fla. Stat. § 119.07(5)(a)2 and 6]

40. PURCHASING AGREEMENTS AND STATE TERM CONTRACTS: The Purchasing agreements and state term contracts available under s. 287.056 have been reviewed.

41. PUBLIC RECORDS AND CONFIDENTIALITY: Subject to the limited confidentiality afforded pending competitive solicitation by Florida Statute 119.071, the ITB and all Bids are public records subject to disclosure pursuant to the Florida Public Records Law. Requests for tabulations and other records pertinent to the competitive solicitation shall be processed in accordance with the Florida Public Records Law. By submitting a Bid, Bidders will be deemed to have waived any claim of confidentiality based on trade secrets, proprietary rights, or otherwise.

IF THE CONTRACTOR HAS QUESTIONS REGARDING THE APPLICATION OF CHAPTER 119, FLORIDA STATUTES, TO THE CONTRACTOR'S DUTY TO PROVIDE PUBLIC RECORDS RELATING TO THIS CONTRACT, CONTACT THE CUSTODIAN OF PUBLIC RECORDS AT 904-547-7637; sjpubrec@stjohns.k12.fl.us ; OR ST. JOHNS COUNTY SCHOOL BOARD, ATTN: COMMUNITY RELATIONS, 40 ORANGE STREET, ST. AUGUSTINE, FL 32084

Certification Regarding Debarment, Suspension, Ineligibility and Voluntary Exclusion - Lower Tier Covered Transactions

This certification is required by the Department of Education regulations implementing Executive Order 12549, Debarment and Suspension, 34 CFR Part 85, for all lower tier transactions meeting the threshold and tier requirements stated at Section 85.110.

1. By signing and submitting this proposal, the prospective lower tier participant is providing the certification set out below.
2. The certification in this clause is a material representation of fact upon which reliance was placed when this transaction was entered into. If it is later determined that the prospective lower tier participant knowingly rendered an erroneous certification, in addition to other remedies available to the Federal Government, the department or agency with which this transaction originated may pursue available remedies, including suspension and/or debarment.
3. The prospective lower tier participant shall provide immediate written notice to the person to whom this proposal is submitted if at any time the prospective lower tier participant learns that its certification was erroneous when submitted or has become erroneous by reason of changed circumstances.
4. The terms "covered transaction," "debarred," "suspended," "ineligible," "lower tier covered transaction," "participant," "person," "primary covered transaction," "principal," "proposal," and "voluntarily excluded," as used in this clause, have the meanings set out in the Definitions and Coverage sections of rules implementing Executive Order 12549. You may contact the person to which this proposal is submitted for assistance in obtaining a copy of those regulations.
5. The prospective lower tier participant agrees by submitting this proposal that, should the proposed covered transaction be entered into, it shall not knowingly enter into any lower tier covered transaction with a person who is debarred, suspended, declared ineligible, or voluntarily excluded from participation in this covered transaction, unless authorized by the department or agency with which this transaction originated.

6. The prospective lower tier participant further agrees by submitting this proposal that it will include the clause titled "Certification Regarding Debarment, Suspension, Ineligibility, and Voluntary Exclusion - Lower Tier Covered Transactions," without modification, in all lower tier covered transactions and in all solicitations for lower tier covered transactions.
7. A participant in a covered transaction may rely upon a certification of a prospective participant in a lower tier covered transaction that it is not debarred, suspended, ineligible, or voluntarily excluded from the covered transaction, unless it knows that the certification is erroneous. A participant may decide the method and frequency by which it determines the eligibility of its principals. Each participant may, but is not required to, check the Nonprocurement List.
8. Nothing contained in the foregoing shall be construed to require establishment of a system of records in order to render in good faith the certification required by this clause. The knowledge and information of a participant is not required to exceed that which is normally possessed by a prudent person in the ordinary course of business dealings.
9. Except for transactions authorized under paragraph 5 of these instructions, if a participant in a covered transaction knowingly enters into a lower tier covered transaction with a person who is suspended, debarred, ineligible, or voluntarily excluded from participation in this transaction, in addition to other remedies available to the Federal Government, the department or agency with which this transaction originated may pursue available remedies, including suspension and/or debarment.

Instructions for Certification:

1. The prospective lower tier participant certifies, by submission of this proposal that neither it nor its principals are:
 - (a) presently debarred, suspended, proposed for debarment, declared ineligible, or voluntarily excluded from participation in this transaction by any Federal department or agency;
 - (b) have not within a three-year period preceding this application been convicted of or had a civil judgment rendered against them for commission of fraud or a criminal offense in performing a public (federal, state or local) transaction or contract under a public transaction; or for violation of federal or state antitrust statutes or commission of embezzlement, theft, forgery, bribery, falsification or destruction of records, making false statements or receiving stolen property;
 - (c) are not presently indicted for or otherwise criminally or civilly charged by a government entity (federal, state or local) with commission of the offenses enumerated in this certification; or
 - (d) have not within a three-year period preceding this application had one or more public transaction (federal, state or local) terminated for cause or default.
2. Where the prospective lower tier participant is unable to certify to any of the statements in this certification, such prospective participant shall attach an explanation to this proposal.

Name of Applicant	PR/Award Number and/or Project Name
Printed Name	Title of Authorized Representative
Signature	Date

DRUG FREE WORKPLACE CERTIFICATION FORM

In accordance with 287.087, Florida Statutes, preference shall be given to businesses with drug-free workplace programs. Whenever two or more bids, which are equal with respect to price, quality, and service, are received by the state or by any political subdivision for the procurement of commodities or contractual services, a bid received from a business that certifies that it has implemented a drug-free workplace program *shall be given preference* in the award process. Established procedures for processing tie bids will be followed if none of the tied vendors have a drug-free workplace program. In order to have a drug-free program, a business shall:

- 1) Publish a statement notifying employees that the unlawful manufacture, distribution, dispensing, possession, or use of a controlled substance is prohibited in the workplace and specifying the action that will be taken against employees for violations of such prohibition.
- 2) Inform employees about the dangers of drug abuse in the workplace, the business's policy of maintaining a drug-free workplace, any available drug counseling, rehabilitation, and employee assistance programs, and the penalties that may be imposed upon employees for drug abuse violations.
- 3) Give each employee engaged in providing the commodities or contractual services that are under bid a copy of the statement specified in subsection (1).
- 4) In the statement specified in subsection (1), notify the employees that, as a condition of working on the commodities or contractual services that are under bid, the employee will abide by the terms of the statement and will notify the employer of any conviction of, or plea of guilty or nolo contendere to, any violation of chapter 893 or of any controlled substance law of the United States or any state, for a violation occurring in the workplace no later than five (5) days after such conviction.
- 5) Impose a sanction on, or require the satisfactory participation in a drug abuse assistance or rehabilitation program if such is available in the employee's community, by any employee who is so convicted.
- 6) Make a good faith effort to continue to maintain a drug-free workplace through implementation of this section.

As the person authorized to sign the statement, I certify that this firm complies fully with the above requirements.

(Vendor's Signature)



BIDDER’S STATEMENT OF PRINCIPAL PLACE OF BUSINESS

(Must be completed & submitted with each competitive solicitation)

Bid number and description: _____

Identify the state in which the Vendor has its principal place of business: _____

Instructions: IF your principal place of business above is located within the State of Florida, the Vendor must sign below and submit this form with your bid response, no further action is required.

However, if your principal place of business is outside of the State of Florida, the following must be completed by an attorney and returned with your bid response. FAILURE TO COMPLY SHALL BE CONSIDERED TO BE NON-RESPONSIVE TO THE TERMS OF THE SOLICITATION.

OPINION OF OUT –OF-STATE BIDDER’S ATTORNEY ON BIDDING PREFERENCES

(To be completed by the Attorney for an Out-of-State Vendor)

NOTICE: Section 287.084(2), Florida Statute, provides that “a vendor whose principal place of business is outside this state must accompany any written bid, proposal, or reply documents with a written opinion of an attorney at law licensed to practice law in that foreign state, as to the preferences, if any or none, granted by the law of that state (or political subdivision thereof) to its own business entities whose principal places of business are in that foreign state in the letting of any or all public contracts.” See also: Section 287.084(1), Florida Statutes.

LEGAL OPINION ABOUT STATE BIDDING PREFERENCES

(Please Select One)

_____ The Vendor’s principal place of business is in the State of _____ and it is my legal opinion that the laws of that state **do not grant a preference** in the letting of any or all public contracts to business entities whose principal places of business are in that state.

_____ The Vendor’s principal place of business is in the State of _____ and it is my legal opinion that the laws of that state **grant the following preference(s)** in the letting of any or all public contracts to business entities whose principal places of business are in that state: (Please describe applicable preference(s) and identify applicable preference(s) and identify applicable state law(s)):

LEGAL OPINION ABOUT POLITICAL SUBDIVISION BIDDING PREFERENCES

(Please Select One)

_____ The Vendor’s principal place of business is in the political subdivision of _____ and it is my legal opinion that the laws of that political subdivision **do not grant a preference** in the letting of any or all public contracts to business entities whose principal places of business are in that political subdivision.

_____ The Vendor’s principal place of business is in the political subdivision of _____ and the laws of that political subdivision **grant the following preference(s)** in the letting of any or all public contracts to business entities whose principal places of business are in that political subdivision: (Please describe applicable preference(s) and identify applicable authority granting the preference(s)):

Signature of out-of-state Vendor’s attorney: _____

Attorney’s printed name: _____

Address of out-of-state Vendor’s attorney: _____

Phone number/e-mail of out-of-state Vendor’s attorney: _____

Attorney’s states of bar admission: _____

Vendor’s Signature: _____

Vendor’s Printed Name: _____



**St. Johns County
School District**

**PROJECT MANUAL, CONTRACT DOCUMENTS
AND SPECIFICATIONS**

**ST. JOHNS COUNTY SCHOOL DISTRICT
PAVEMENT REHABILITATION
BID NO. 2017-03**

BID SET

**FOR
ST. JOHNS COUNTY SCHOOL DISTRICT**

BY

PROSSERTM

Consulting Engineer:

**Prosser, Inc.
13901 Sutton Park Drive South
Jacksonville, Florida 32224**

PH Ref. No. 98008.18

January 11, 2017

ADVERTISEMENT FOR BIDS

ST. JOHNS COUNTY SCHOOL DISTRICT BID NO. 2017-03 PAVEMENT REHABILITATION

Sealed bids will be received by the St. Johns County School Board for the Paving and Sitework project located at the following schools in St. Johns County, Florida:

- **Cunningham Creek Elementary- 1205 Roberts Rd, St. Johns, FL 32259**
- **Mill Creek Elementary- 3750 International Golf Parkway, St. Augustine, FL 32092**
- **WD Hartley Elementary- 260 Cacique Drive, St Augustine, FL 32086**
- **RB Hunt Elementary- 125 Magnolia Drive, St Augustine, FL 32080**
- **Otis Mason Elementary- 207 Mason Manatee Way, St Augustine, FL 32086**
- **Osceola Elementary- 1605 Osceola Elementary Road, St Augustine, FL 32084**
- **Creekside High School- 100 Knights Lane, St Johns, FL 32259**
- **Ponte Vedra High School- 460 David Park Road, Ponte Vedra, FL 32081**
- **Liberty Pines Academy- 10901 Russell Sampson Road, St. Johns, FL 32259**

The work shall include but not be limited to the following:

- **Asphalt Remove and Replace**
- **Full Depth Asphalt Repair**
- **Asphalt Sealcoating**
- **Asphalt Crack sealing**
- **Pavement Markings**
- **Regulatory Signage Replacement**
- **Curb Painting**
- **New Asphalt Construction**
- **Curb, Removal, Installation & Repair**
- **Wheel stop Installation & Repair**
- **Sidewalk Installation & Repair**

All parts, labor, and material, temporary facilities and restoration to provide work completed and in place.

BIDDING DOCUMENTS

Drawings and specifications may be downloaded commencing Wednesday, January 11, 2017 at www.demandstar.com Bidders can also obtain hard copies upon payment of \$50.00 (non-refundable) per set plus cost of mailing and handling. Hard copies will be available at **Prosser, Inc., 13901 Sutton Park Drive S., Suite 200, Jacksonville, FL 32224**

Anyone wishing to visit the site should contact **Mr. David Lee, Director for Maintenance Services 904-547-3707.**

PRE-BID CONFERENCE

A Pre-bid Conference will be held at the office of Mr. David Lee, Director for Maintenance Services, St. Johns County School District, 299 School House Road, St. Augustine, Florida 32084 on Thursday, January 19, 2017 at **2:00 pm**. All bona fide bidders are requested to attend.

BIDDER QUESTIONS

In order to maintain a fair and impartial competitive process, prospective bidders shall not communicate with District staff or Board members after bids are released. All questions and inquiries must be submitted via email no later than **Monday January 30, 2017 at 12:00 PM** to:

Patrick Snodgrass
Director of Purchasing
patrick.snodgrass@stjohns.k12.fl.us

Communication via email as stated above is the only means prospective bidders may contact the District regarding this solicitation. Violation of this section is grounds for automatic disqualification of a prospective bidder's submittal.

All questions will be answered via posting to the DemandStar website www.demandstar.com no later than **Tuesday January 31, 2017 @ 5:00 PM**.

The District will not respond to questions and inquiries submitted after the deadline stated above.

Copies of addendum will be made available for inspection at the District's Purchasing Department where bid documents will be kept on file.

No Addendum will be issued later than **January 31, 2017**, except an addendum withdrawing the Invitation to Bid or one which includes postponement of the date for receipt of bids or one containing the questions and answers.

All notices relative to this Bid, including but not limited to initial release, addendums, letters of intent and awards will be posted on the DemandStar web site – www.demandstar.com.

SUBMITTAL OF BID

All bids must be received no later than **Monday, February 13, 2017 @ 1:30 PM** and must be delivered to:

**St. Johns County School District – Sebastian Administrative Annex
Attn: Patrick Snodgrass, Director of Purchasing
3015 Lewis Speedway, Unit 5
St. Augustine, FL 32084**

All bid proposals must be on the appropriate proposal forms, properly executed, placed in an envelope, marked to identify the bid and then shall be delivered to the St. Johns County School District. Proposals may not be altered by written direction on the outside of the envelope.

If a bid is transmitted by US mail or other delivery medium, the bidder will be responsible for its timely delivery to the address indicated. Bids received after that time will not be accepted.

BID OPENING

The bids will then be **opened publicly Monday, February 13, 2017 at 2:00 PM** and read aloud. All bidders will be required to be pre-qualified with the St. Johns County School District or must submit all required documentation before the bid, or simultaneously with their bid to be considered for possible award of the contract. In any event, ***the successful bidder must be pre-qualified by the St. Johns County School District prior to award of the contract.*** For more information on pre-qualification, contact: David Lee, Director for Maintenance Services, St. Johns County School District, 299 School House Road, St. Augustine, Florida 32084. Additionally, it is mandatory that the successful bidder (s) comply with all terms and conditions of the Jessica Lunsford Act.

Bid security in the amount of five percent (5%) of the bid in the form of a check made payable to the St. Johns County School District or in the form of a bid bond, executed by the bidder, a surety duly qualified to do business in the State of Florida and resident agent, shall accompany each proposal in accordance with Instruction to Bidders. No bid may be withdrawn for a period of forty-five (45) days after the opening. After opening the bids, and in the event the contract is awarded to the bidder, the bidder will be obligated to execute the contract and furnish the required bond within ten (10) days after receipt of the contract. Should the bidder fail to meet the obligation, the bid security shall be forfeited and become the property of the St. Johns County School District as fixed and reasonable liquidated damages. The successful bidder will be required to furnish a 100% Performance Bond and a 100% Material Bond, which shall remain in effect until the date of final inspection and acceptance by the Owner; and shall file certificates with the Owner that he has obtained and will continue to carry Workers' Compensation Insurance, Owner's Protection Insurance, Public and Private Liability and Property Damage Insurance in adequate amount for the life of the contract.

The St. Johns County School District reserves the right to reject any and all bids, waive informalities and irregularities in bidding, and to accept bids which are considered to be in the best interest of the School District. **Contractor should be cautioned that the St. Johns County School District reserves the right to award individual school jobs to individual contractors.**

SECTION A

INFORMATION FOR BIDDERS

A-1. SUBMISSION OF BIDS AND BID OPENING:

- A. Bids will be received by the Construction Program Manager and will be opened and read at the times and places set forth in the Advertisement for Bids. Bidders, or their representative, and other interested persons may be present at the opening of proposals.
- B. The envelopes containing the bids must be sealed and addressed to **St. Johns County School District, 3015 Lewis Speedway, Unit 5, St. Augustine, Florida 32084**, and marked on the outside of the envelope "**Proposal for St. Johns County School District, Bid No. 2017-03 Pavement Rehabilitation**", with the name of the Bidder and his Florida Contractor's Registration Number.
- C. The Bidder shall assume full responsibility for timely delivery at the location designated for receipt of Bids.

A-2. BIDDING DOCUMENTS:

- A. Bidding Documents include the Advertisement for Bids, Information for Bidders, Form of Proposal, the Bid Security and the proposed Contract Documents, including any Addenda issued prior to receipt of bids. All requirements and obligations of the Bidding Documents are hereby incorporated by reference into the Contract Documents and are binding on the Successful Bidder upon award of the contract.
- B. Bidders may obtain complete sets of the bidding Documents from the issuing office designated in the Advertisement for Bids in the number and for the price, if any, stated therein.
- C. Bidders shall use complete sets of Bidding Documents in preparing Bids; neither the Owner, the Construction Program Manager nor the Design Consultant shall have any responsibility for errors or misinterpretations resulting from the use of incomplete sets of Bidding Documents.
- D. The Owner in making copies of the Bidding Documents available on the above terms does so only for the purpose of obtaining Bids on the Work and does not confer a license or grant for any other use.

A-3. DEFINITIONS:

A. THE BID:

A Bid is a complete and properly signed proposal to do the work or designated portion thereof for the sums stipulated therein, submitted in accordance with the Bidding Documents.

B. BASE BID:

The Base Bid is the sum stated in the Bid for which the Bidder offers to perform the Work described in the Bidding Documents as the base, to which work may be added or from which work may be deleted for sums stated in Alternate Bids, if any.

C. ALTERNATES:

An Alternate Bid (or Alternate) is an amount stated in the Bid to be added to or deducted from the amount of the Base Bid if the corresponding change in the Work, as described in the Bidding Documents, is accepted.

A-4. QUALIFICATION OF BIDDER:

- A. The Successful Bidder shall perform at least twenty-five percent (25%) of the work with forces that are in the direct employment of the Contractor's organization. Prior to the signing of the contract, the successful Bidder shall submit a statement of work to be performed by his own forces.
- B. Prior to Contract award, the successful Bidder shall be prepared to demonstrate that his present organization, direct labor force and prior work experience is of adequate size and development to maintain responsible control of the project and to schedule, coordinate and perform the work in an expeditious manner and in accordance with the Contract Documents. Contractor shall complete and deliver to the Construction Program Manager a Bidder's Qualification Statement and audited financial statements for the current and past year, as set forth in the Contract Documents, prior to contract award. This information will be relied upon and investigated by Owner in determining whether Bidder is the best, responsible and most qualified Bidder.
- C. Bidders, whether residents or nonresidents of **Florida** will be required to show evidence of a certificate of registration before their bids will be considered.
- D. The Owner and the Construction Program Manager will consider, in determining the qualifications of a Bidder, his record in the performance of any contracts for construction work into which he may have entered with the Owner or with similar public or private bodies or corporations. The Owner expressly reserves the right to reject the bid of any Bidder if such record discloses that such Bidder, in the opinion

of the Owner, or the Construction Program Manager is not the best or most responsible and qualified Bidder or that Bidder has not properly performed its contracts or has habitually and without just cause neglected the payment of bills, or has otherwise disregarded his obligations, Subcontractors, material men, suppliers or employees.

- E. The Owner or the Construction Program Manager may make such investigation as they deem necessary to determine the responsibility, qualifications and ability of the Bidder to perform the work, and the Bidder shall furnish to the Owner or the Construction Program Manager all such information and data for this purpose as they may request. The Owner reserves the right to reject any bid if the evidence submitted by, or investigation of such Bidder, fails to satisfy the Owner or the Construction Program Manager that such Bidder is a responsive and responsible Bidder in accordance with the criteria set forth herein. The ability to secure payment and performance bonds for the Work shall not be conclusive evidence of Bidder's financial responsibility. Conditional bids will not be accepted.

A-5. BIDDER'S REPRESENTATIONS:

- A. Each Bidder by submitting his Bid understands Owner is relying upon the bid and the representations contained therein in awarding the Contract and represents that:
1. He has read and understands that Bidding Documents and his Bid is made in accordance therewith; and Bidder agrees to be bound by the terms and requirements set forth in the Bidding and Contract Documents;
 2. He has visited the site, has familiarized himself with the local conditions under which the Work is to be performed in accordance with Article A-8 herein, and has correlated his observations with the requirements of the proposed Contract Documents;
 3. His Bid is based upon the materials, systems and equipment required by the Bidding Documents without exception; and
 4. He has the capability, in all respects, and the moral and business integrity, reliability, technical ability, financial resources, plant, management, superintendence, equipment and materials which will assure effective and efficient good faith performance in full compliance with the Contract Documents and with any and all schedules and Milestone and Completion dates required by the Owner. The Bidder acknowledges and represents that he has made allowances for normal inclement weather indigenous to the Project Site, in his estimating, planning and scheduling of the Work. The Bidder hereby certifies that the work shall be completed, in place, in full accordance with the Contract Documents, within the time limits specified.

- B. He agrees that upon receipt of the Notice of Acceptance of his bid, he will execute the formal Contract, and will deliver all bonds and proof of insurance coverage as required by the Specifications.
- C. He agrees to execute the formal Contract within ten (10) days from the date of Notice of Award of the Contract, and in case he fails or neglects to appear within the specified time to execute the Contract, he will be considered as having abandoned the Contract, and the Bid Security accompanying this Proposal will be forfeited to the Owner by reason of such failure on the part of the Bidder.
- D. Contractor shall submit a complete list of all subcontractors to owner immediately upon notice of apparent low bidder status and prior to award of the Contract. Owner shall consider such matters as it deems fit as to each sub-contractor and how, if at all, it impacts on Contractor's responsibility, fitness or ability to perform this Contract. In addition, Contractor shall submit for approval its as-planned schedule pursuant to the requirements of Article 4 of the General Conditions.

A-6. BID SECURITY:

- A. Each bid must be accompanied by (1) cash, (2) a Cashier's or Certified Check of the Bidder, made payable to the Owner, or (3) a bidder's bond on the Bid Bond Form provided herein in an amount not less than 5% of his bid. For purposes of this provision, the amount of the bid shall be the Base Bid plus all positive amount alternates. The bidders bond shall be issued by a surety company licensed to conduct business in **Florida**, which is on the approved U.S. Treasury List, which obtained an A+ rating by the latest Best Insurance Guide and which is otherwise acceptable to the Owner.
- B. Said bid security is given as a guarantee that the Bidder will enter into a contract if awarded the work and, in the case of refusal or failure to so enter into said contract, the security shall be declared forfeited to the Owner. Such security shall be returned to all but the three lowest Bidders within three days after the opening of bids and the remaining security will be returned within 48 hours after the Owner and the successful Bidder have executed the Contract. If no Contract has been awarded or the bidder has not been notified of the acceptance of his bid, within forty-five (45) days of the bid opening, the Bidder may withdraw his bid and request the return of his bid security. If, at the Owner's or construction Program Manager's request, the Bidder agrees to extend and maintain his bid beyond the specified 45 days, his bid security will not be returned. Bidder hereby agrees that all Bid prices are firm, fixed prices which the Owner may accept up to 45 days from Bid opening.

A-7. LIQUIDATED DAMAGES:

The Successful Bidder, upon his failure or refusal to execute the Contract within ten (10) days after he has received notice of the acceptance of his bid, shall forfeit to the Owner the security deposited with his bid, as liquidated damages for such failure or refusal.

A-8. SITE CONDITIONS AND CONDITIONS OF THE WORK:

- A. Each bidder must acquaint himself thoroughly as to the character and nature of the work to be done. Each bidder furthermore must make a careful examination of the site of the work and inform himself fully as to the difficulties to be encountered in the performance of the work, the facilities for delivering, storing and placing materials and equipment, and other conditions relating to construction and labor.
- B. No plea of ignorance of conditions that exist or may hereafter exist on the site of the work, or difficulties that may be encountered in the execution of the work, as a result of failure to make necessary investigations and examinations, will be accepted as an excuse for any failure or omission on the part of the successful Bidder to fulfill in every detail all the requirements of the Contract Documents and to complete the Work for the consideration set forth therein, or as a basis for any claim whatsoever from the Bidder. Bidder specifically waives any such claim(s).
- C. Insofar as possible, the Successful Bidder, in carrying out his work, must employ such methods or means as will not cause interruption of or interference with the Work of the Owner, the Construction Program Manager or any separate contractor.
- D. Contractor is to verify that all pavement areas have been adequately addressed, if there is any area of pavement not shown on the plan that he feels should be repaired, he needs to bring that area to the attention of the Engineer.

A-9. BIDDER'S QUESTIONS, ADDENDA AND INTERPRETATIONS:

- A. Bidders and Sub-bidders shall promptly notify the Owner, prior to submission of their Bid, through the Construction Program Manager of any ambiguity, inconsistency or error which they may discover upon examination of the Bidding and Contract Documents or of the site and local conditions. No interpretation of the meaning of the drawings, specifications or other contract documents will be made to any Bidder orally, nor may Bidder rely on any such pre-bid statements in completing his Bid.
- B. Every request for such interpretation should be in writing addressed to the **Director of Purchasing for the St. Johns County School District.**
- C. Any and all such interpretations and any supplemental instructions will be in the form of written addenda to the Bidding Documents which, if issued, will be mailed to all prospective Bidders (at the respective addresses furnished for such purposes) prior to the date or time fixed for the opening of bids. Neither the Construction Program Manager nor the Owner will not be responsible for any other explanations or interpretations of the proposed documents. Failure of any Bidder to receive any such addendum or interpretation shall not relieve any bidder from any obligation

under his bid as submitted. All addenda so issued shall become part of the Contract Documents.

- D. Each Bidder shall ascertain prior to submitting his bid that he has received all Addenda issued, and he shall acknowledge receipt and inclusion in his proposal of all Addenda.

A-10. SECURITY FOR FAITHFUL PERFORMANCE:

The Successful bidder shall furnish and record in the official records of the county where the project is located a Performance Bond in an amount equal to one hundred percent (100%) of the Contract Sum as security for the faithful performance of this Contract and also a Labor and Material Payment Bond in an amount not less than one hundred percent (100%) of the Contract Sum, as security for the payment of all persons performing labor and furnishing materials under this Contract. Both the Performance Bond and Labor and Material Payment Bond shall be in the forms set forth in the Contract Documents and shall be written by sureties which are licensed to do business in the State of Florida, which are currently on the approved U.S. Treasury List of Sureties, which maintain an A+ rating with Best Insurance Guide, and are otherwise acceptable to the Owner. The Performance Bond and the Labor and Material Payment Bond shall be in separate instruments and shall be delivered to the Owner not later than the date of execution of the Contract. No work or mobilization may proceed until both bonds are executed and delivered to Owner.

A-11. TIME FOR COMPLETION AND LIQUIDATED DAMAGES FOR NON-COMPLETION:

The time for completion of this Contract and liquidated damage for non-completion within the stipulated time shall be as fixed in the Owner-Contractor Agreement.

A-12. LOCATION OF WORK:

The site of the proposed work is on property provided by the Owner, public streets, easements and/or other right-of-ways, as shown on the drawings.

A-13. LIABILITY INSURANCE AND WORKMEN'S COMPENSATION:

The Successful Bidder will be required to carry public liability and workmen's compensation and other insurance in the amounts and under the terms stipulated under the General Conditions.

A-14. BIDDERS REFERRED TO LAWS:

- A. The attention of Bidders is called to the provisions of all Municipal, County and State laws, regulations, ordinances and resolutions, including but not limited to, (the Human Rights Ordinance; the Equal Opportunity, Small and Minority

Business Enterprises and the Construction Safety Resolutions; Chapter 6A-2 FAC; Florida Statute 553, The Trench Safety Act); as well as laws, regulations, ordinance resolutions and permits relating to obstructing streets, maintaining signals, storing and handling of explosives, or affecting the Bidder, or his employees or his work hereunder in his relation to the Owner or any other person. The Bidder shall obey all such laws, regulations, ordinances, permits or resolutions controlling or limiting Contractors while engaged in the prosecution of work under this Contract.

- B. The provisions of this contract shall be interpreted in accordance with the laws of **Florida** and in accordance with the laws, ordinances, regulations, permits and resolutions of **St. Johns County**, if applicable.

A-15. TAXES

All applicable Federal, State and Local Taxes shall be included in the Bidder's proposal. Owner reserves the right to direct purchase materials at Contractor's negotiated prices with materialmen and thereby generate a tax savings to itself.

A-16. RIGHT TO REJECT BIDS:

The Owner expressly reserves the right to reject any or all bids, to waive any informalities or minor irregularities in the bids received, and to accept that bid which in its judgment, best serves the interest of the Owner. Owner hereby retains full discretion to determine the responsiveness of the bid and Bidder's responsibility, character, fitness and experience to perform the Work.

A-17. EQUAL PRODUCTS AND SUBSTITUTIONS:

- A. Unless otherwise provided in the Contract Documents the naming of a certain brand, make or manufacturer or article, device, product, material, fixture, form or type construction by name, make or catalog number, shall convey the general style, type, character and standard of quality of the article desired and shall not be construed as limiting competition. Any bidder, in such cases, may, with Owner approval, use any article, device, product, material, fixture, form or type of construction which in the judgment of the Design Consultant, the Construction Program Manager and Owner is equal to that specified considering quality, workmanship, economy of operation, suitability for the purpose intended, and acceptability for use on the project. Approval by the Owner prior to bid opening will be in the form of an Addendum to the Specifications issued to all prospective Bidders indicating that the additional makes or brands are equivalent to those specified.
- B. The bidder may request approval for substitutions after award of the contract in accordance with the provisions of Article 4.15 of the contract General Conditions.

A-18. PREPARATION AND SUBMITTAL OF FORM OF BID:

- A. Bidder's are requested to organize their bids in the following sequence:
- a. Bid Cover Sheet
 - b. Debarment Form
 - c. Drug Free Workplace Certification
 - d. Principal Place of Business
 - e. Insurance Coverage
 - f. License
 - g. Reference
 - h. Section B - Form of Proposal

Bids shall be submitted utilizing the Form of Proposal as bound herein, or otherwise provided with the Contract Documents, and shall be complete in every respect. The total bid amount shall be entered in words and figures in the space provided. Where applicable, the unit price or lump sum items, and their extensions, shall be entered in figures in the respective columns provided for each bid item. All entries shall be typewritten or printed in ink. The signatures of all persons shall be in longhand. Any entry of amount that appears on the face of the bid to have involved an erasure, deletion, white-out and/or substitution or other such change or alteration, shall show by them the initials of the person signing the bid and the date of the change or alteration. A failure to comply with this requirement may be cause for disqualification or rejection of the bid.

- B. For Unit Price bids, in the event of any discrepancies between the unit prices and the extensions thereof or the total bid amount, the unit prices shall govern. For Lump Sum bids, in the event of a discrepancy between the bid amount in writing and that in figures, the written value shall govern.
- C. Bids shall not contain any conditions, restatement or qualifications of work to be done, and alternate bids will not be considered unless called for. No oral bids or modifications will be considered.

A-19. MODIFICATION OR WITHDRAWAL OF BID:

- A. Prior to the time and date designated for receipt of bids, any bid submitted may be modified or withdrawn by notice to the party receiving bids at the place designated for receipt of bids. Such notice shall be in writing over the signature of the Bidder or by telegrams; if by telegram, written confirmation over the signature of the Bidder shall be mailed and postmarked on or before the date and time set for receipt of bids, and it shall be so worded as not to reveal the amount of the original bid.

- B. Withdrawn bids may be resubmitted up to the time designated for the receipt of Bids provided that they are then fully in conformance with this Information for Bidders.
- C. Bid security, if any is required, shall be in an amount sufficient for the bid as modified or resubmitted.

A-20. DETAILED BID BREAKDOWN:

If the Owner or the Construction Program Manager directs, the Bidder shall provide a detailed breakdown and internal job cost estimate of his bid acceptable to the Owner or the construction Program Manager. In addition to verifying accounting requirements, the breakdown may be used by the Owner to determine whether the Bidder has grossly misjudged the requirements of any area. Failure to provide the requested detailed breakdown may result in rejection of the bid proposal or, if after contract award, may be deemed a default or breach of the Contract.

A-21. AWARD OF CONTRACT:

The contract will be awarded to the lowest responsive and responsible Bidder, and whose bid is considered to be in the best interest of the Owner. This determination will be in the sole discretion of the Owner and based upon the character, fitness, experience, history and financial status of the Bidder. Dependent on the individual base bid amounts, the Owner reserves the right to award partial bids to the Contractor.

- A. The Lowest Bidder is determined by the aggregate amount of the unit prices set forth in the form of bid, if work is bid on a unit price basis, or the individual amount of the Base Bid items.
- B. A Responsive Bidder shall mean a Bidder who has submitted a bid which conforms, in all material respects, to the Bidding Documents.
- C. A Responsible Bidder shall mean a Bidder who has the capability, in all respects, to perform fully the contract requirements and the moral and business integrity and reliability which will assure good faith performance. In determining responsibility, the following criteria will be considered:
 - 1. The ability, capacity and skill of the Bidder to perform the contract or provide the service required;
 - 2. Whether the bidder can perform the contract or provide the service promptly, or within the time specified, without delay or interference;
 - 3. The character, integrity, reputation, judgment, experience and efficiency of the Bidder;

4. The quality of performance of previous contracts or services. For example, the following information will be considered:
 - a. The administrative and consultant cost overruns incurred by Owners on previous contracts with Bidder,
 - b. The Bidder's compliance record with contract general conditions on other projects,
 - c. The submittal by the bidder of excessive and/or unsubstantiated extra cost proposals and claims on other projects,
 - d. The Bidder's record for completion of the work within the Contract Time or within Contract Milestones and Bidders compliance with scheduling and coordination requirements on other projects,
 - e. The Bidder's demonstrated cooperation with the Owner, the Construction Program Manager or the Design Consultant and other contractors on previous contracts,
 - f. Whether the work performed and materials furnished on previous contracts was in accordance with the Contract Documents;
5. The previous and existing compliance by the bidder with laws and ordinances relating to contracts or services;
6. The sufficiency of the financial resources and ability of the Bidder to perform the contract or provide the service;
7. The quality, availability and adaptability of the goods or services to the particular use required;
8. The ability of the Bidder to provide future maintenance and service for the warranty period of the contract;
9. Whether the Bidder is in arrears to any Owner on debt or contract or is a defaulter on surety to any Owner;
10. Such other information as may be secured by the Owner or the Construction Program Manager having a bearing on the decision to award the contract, to include, but not limited to:
 - a. The ability, experience and commitment of the Bidder to properly and reasonably plan, schedule, coordinate and execute the Work,

- b. Whether the Bidder has ever been debarred from bidding by any other public or private owner or found ineligible for bidding on any other projects.
 - c. Bidder's litigation history and reputation with owners for whom Bidder has previously worked.
 - d. Bidder's Public Entity crime statement, which must be returned with the Bid or which may form the basis for bid rejection.
 - e. Whether Bidder's contract on other projects has ever been terminated.
- D. The purpose of the above is to enable the Owner to select the bid which is in the best interests of the Owner. The ability of the low Bidder to provide the required bonds will not of itself demonstrate responsibility of the Bidder.
- E. The Owner reserves the right to defer award of this contract for a period of forty-five (45) days after the due date of bids. During this period time, the Bidder shall guarantee the prices quoted in his bid.

END OF SECTION A
INFORMATION FOR BIDDERS

SECTION B

FORM OF PROPOSAL

CONTRACT FOR ST. JOHNS COUNTY SCHOOL DISTRICT

BID NO. 2017-03 PAVEMENT REHABILITATION

TO: **St. Johns County School District**
3015 Lewis Speedway, Unit 5
St. Augustine, Florida 32084

FROM: _____
Bidder

Address

City State Zip

1. BASE BID PROPOSAL:

Having become familiar with the local conditions affecting the cost of work at the place where work is to be executed, and having carefully examined the site conditions as they currently exist, and having carefully examined Bidding and Contract Documents as prepared by **Prosser, Inc.**, and titled **St. Johns County School District Bid No. 2017-03 Pavement Rehabilitation**, dated _____ **2017** together with any addenda to such Bidding Documents as listed hereinafter, the undersigned hereby proposed and agrees to provide all labor, materials, plant, equipment, transportation and other facilities as necessary and/or required to execute all of the work described by the aforesaid Bidding and Contract Documents for:

BASE BID ITEM NO. 1: Cunningham Creek Elementary

Lump Sum consideration of :

_____ Dollars (\$ _____),

said amount being hereinafter referred to as Base Bid Item No. 1 or Base Bid Item No. 1 Proposal.

BASE BID ITEM NO. 2: Mill Creek Elementary

Lump Sum consideration of :

_____ Dollars (\$ _____),

said amount being hereinafter referred to as Base Bid Item No. 2 or Base Bid Item No. 2 Proposal.

BASE BID ITEM NO. 3: Hartley Elementary

Lump Sum consideration of :

_____ Dollars (\$ _____),

said amount being hereinafter referred to as Base Bid Item No. 3 or Base Bid Item No. 3 Proposal.

BASE BID ITEM NO. 4: RB Hunt Elementary

Lump Sum consideration of :

_____ Dollars (\$_____),

said amount being hereinafter referred to as Base Bid Item No. 4 or Base Bid Item No. 4 Proposal.

BASE BID ITEM NO. 5: Otis Mason Elementary

Lump Sum consideration of :

_____ Dollars (\$_____),

said amount being hereinafter referred to as Base Bid Item No. 5 or Base Bid Item No. 5 Proposal.

BASE BID ITEM NO. 6: Osceola Elementary

Lump Sum consideration of :

_____ Dollars (\$_____),

said amount being hereinafter referred to as Base Bid Item No. 6 or Base Bid Item No. 6 Proposal.

BASE BID ITEM NO. 7: Creekside High School

Lump Sum consideration of :

_____ Dollars (\$_____),

said amount being hereinafter referred to as Base Bid Item No. 7 or Base Bid Item No. 7 Proposal.

BASE BID ITEM NO. 8: Ponte Vedra High School

Lump Sum consideration of :

_____ Dollars (\$_____),

said amount being hereinafter referred to as Base Bid Item No. 8 or Base Bid Item No. 8 Proposal.

BASE BID ITEM NO. 9: Liberty Pines Academy

Lump Sum consideration of :

_____ Dollars (\$_____),

said amount being hereinafter to as Base Bid Item No. 9 or Base Bid Item No. 9 Proposal.

Additional Work:

Additional work may be required as needed. The undersigned agrees to perform the following as needed at unit cost for materials and labor.

<u>Work/Repair.</u>	<u>Unit/Measure</u>	<u>Cost</u>
Seal Coating	1-100 sy 101-500 sy 500+ sy	
Striping/Curb Painting	1-100 lf 101-500 lf 500+ lf	
Full Depth Repair	1-100 sy 101-500 sy 500+ sy	
Sawcut existing asphalt/rework limerock/Overlay	1-100 sy 101-500 sy 500+ sy	
Concrete crack seal	1-100 lf 101-500 lf 500+ lf	
Wheelstops	Each	
Signage (FDOT)	Each	
Curb Repair/Replacement	lf	
Sodding/minor grading	sf	
Asphalt crack seal	1-100 lf 101-500 lf 500+ lf	
Furnish & Install 4" Deep Crushcrete	1-100 sy 101-500 sy 500+ sy	
Installation of new curbing	lf	
1" Asphalt Overlay	1-100 sy 101-500 sy 500+ sy	
1 1/2" Asphalt Overlay	1-100 sy 101-500 sy 500+ sy	
Sawcut existing concrete/install curb ramp	1-100 sy 101-500 sy 500+ sy	
New asphalt/radii enlargement	1-100 sy 101-500 sy 500+ sy	
Asphalt Speed Bump (24' wide)	Each	
Micro-surfacing (1/2")	1-100 sy 101-500 sy 500+ sy	
Milling (1")	1-100 sy 101-500 sy 500+ sy	

2. ADDENDA ACKNOWLEDGMENT:

The undersigned acknowledges receipt of the following addenda: (List by number and date appearing on addenda.)

<u>Addendum No.</u>	<u>Date</u>	<u>Addendum No.</u>	<u>Date</u>
_____	_____	_____	_____
_____	_____	_____	_____
_____	_____	_____	_____
_____	_____	_____	_____

3. BID SECURITY:

Bid security in the amount of five (5) percent of the Base Bid is attached, without endorsement, in the sum of _____ Dollars (\$ _____), which is to become the property of the Owner in the event the Contract and Performance and Labor and Material Payment Bonds are not executed within the time set forth in the Contract Documents, as liquidated damages for the delay and additional work caused the Owner.

- 4. The undersigned declares that the person or persons signing this Proposal is/are fully authorized to sign on behalf of the firm listed and to fully bind the firm listed to all terms of the Bid Solicitation.
- 5. It is agreed that no person or persons or company other than the firm listed below or as otherwise indicated has any interest whatsoever in this proposal or the contract that may be entered into as a result of the Proposal and that in all respects the proposal is legal and firm, submitted in good faith without collusion or fraud.
- 6. It is agreed that the undersigned has complied or will comply with all requirements of local, state, and national laws, and that no legal requirement has been or will be violated in making or accepting this Proposal, in awarding the contract to Bidder and/or in the prosecution by Bidder of the work required.
- 7. The following information is provided pursuant for the Contract Documents:

- .1 Legal Name of Firm:

a. If Firm is a corporation , state that corporation is organized under the laws of the State of _____. Please affix corporate seal to this Form of Bid.
b. If Firm is a partnership, state names of partners:

c. If Firm is an individual using a trade name, state name of individuals:

- .2 Contractor Registration Number: _____
Respectfully submitted, this _____ day of _____, 20____

(Signature)

(Name Typed)

(Title)

(SEAL IF BIDDER IS A CORPORATION)

1. Bid Bond

BID BOND

KNOW ALL MEN BY THESE PRESENTS, That we, _____, of _____, hereinafter called the Principal, and _____, (Surety), a corporation organized and existing under the Laws of the State of _____, and authorized to transact business in the State of _____, as Surety, hereinafter called Surety, are held and firmly bound unto the _____ (Owner), hereinafter called Obligee, in the Penal sum of five percent (5%) of the amount bid, good and lawful money of the United States of America, for the payment of which the Principal and Surety bind themselves, their heirs, executors, administrators, successors and assigns, jointly and severally, firmly by these presents. The Condition of this Obligation is such, that,

WHEREAS the Principal has submitted a bid to the Obligee on a contract for the construction of:

**St. Johns County School District
Bid No. 2017-03 Pavement Rehabilitation**

NOW THEREFORE, if the Obligee shall accept the bid of the Principal and the Principal shall enter into a contract with the Obligee in accordance with the terms of such bid, and give such bond or bonds as may be specified in the Bidding or Contract Documents with good, qualified and sufficient surety for the faithful performance of such construction for the prompt payment of labor and material furnished in the prosecution thereof, then this obligation shall be null and void; otherwise this bid is to remain in full force and effect for the payment to the Obligee of the stated penal sum hereof.

In witness whereof, we have hereunto set our signatures and seal this ____ day of _____, 20____, all pursuant to due authorization.

_____(Seal)

Principal

By _____
Surety

By _____
Attorney-in-Fact in accordance with the attached
Power of Attorney

STATE OF _____)

) ss:

COUNTY OF _____)

I, _____, a Notary Public in and for the State and County aforesaid, do hereby certify that _____, and _____, whose names are signed to the foregoing bond, this day personally appeared before me in my State and County aforesaid and acknowledged the same. Given under my hand and seal this _____ day of _____, 20____.

(Notary Public)

My commission expires:_____

END OF SECTION B
FORM OF PROPOSAL

SECTION C

OWNER-CONTRACTOR AGREEMENT

THIS AGREEMENT, in four (4) copies, made this _____ day of ____, 20__ by and between the **St. Johns County School District** (herein referred to as the "Owner"), whose mailing address is **40 Orange Street, St. Augustine, Florida 32084** and _____ (herein referred to as the "Contractor"), whose mailing address is:

All correspondence, submittals, and notices relating to or required under this Contract shall be sent in writing to the above addresses; unless either party is notified in writing by the other, of a change in address.

WITNESSETH:

WHEREAS, it is the intent of the Owner to obtain the services of the Contractor in connection with the pavement rehabilitation of _____. The Owner reserves the right to award partial bids. Each school may be awarded individually to the lowest responsible bidder, hereinafter any reference to the "Project" or the "Work" will refer to an above referenced St. Johns County School, and

WHEREAS, the Contractor desires to perform such construction on the project in accordance with the terms and conditions of this Agreement,

NOW, THEREFORE, in consideration of the promises made herein and other good and valuable consideration, the following terms and conditions are hereby mutually agreed to, by and between the Owner and Contractor:

Article 1

DEFINITIONS

- 1.1 All terms in this Agreement which are defined in the Information for Bidders and the General Conditions shall have the meanings designated therein.
- 1.2 The Contract Documents are as defined in the General Conditions. Such documents form the Contract, and all are as fully a part hereof as if attached to this Agreement or repeated herein.

Article 2

STATEMENT OF THE WORK

- 2.1 The Contractor shall provide and pay for all materials, tools, equipment, labor and professional and non-professional services, and shall perform all other acts and supply all other things necessary, to fully and properly perform and complete the Work, as required by the Contract Documents.
- 2.2 The Contractor shall further provide and pay for all related facilities described in any of the Contract Documents, including all work expressly specified therein and such additional work as may be reasonably inferred therefrom, saving and excepting only such items of work as are specifically stated in the Contract Documents not to be the obligation of the Contractor. The totality of the obligations imposed upon the contractor by this Article and by all other provisions of the Contract Documents, as well as the structures to be built and the labor to be performed, is herein referred to as the "Work".

Article 3

DESIGN CONSULTANT

- 3.1 The Design Consultant (as defined in the General Conditions) shall be **Prosser, Inc.**, whose address is **13901 Sutton Park Drive South, Suite 200, Jacksonville, FL 32224-0229** provided, however, that the Owner may, without liability to the Contractor, unilaterally amend this Article from time to time by designating a different person or organization to act as its Design Consultant and so advising the Contractor in writing, at which time the person or organization so designated shall be the Design Consultant for purposes of this Contract.

Article 4

TIME OF COMMENCEMENT AND COMPLETION

- 4.1 The Contractor shall commence the Work promptly upon the date established in the Notice to Proceed. If there is no Notice to Proceed, the date of commencement of the Work shall be the date of this Agreement or such other date as may be established herein.
- 4.2 Time is of the essence. The Contractor shall achieve Substantial Completion, as defined in the General Conditions, by the date of **September 22, 2017**. This time period from Notice to Proceed until this date shall be designated the Contract Time. The Contractor must coordinate prior to commencing any construction with David Lee of the St. Johns County School District Maintenance Department. The term of this contract may by mutual agreement between the District and the awarded vendor(s) be renewable for up to two (2) additional one (1) year periods.
- 4.3 All terms and conditions of this bid, any addenda, and negotiated terms are incorporated into the contract by reference as set forth herein.

4.4 The Contractor shall also complete the following activities of Work within the interim Milestone dates indicated, as applicable:

<u>Activity</u>	<u>Date</u>
A. Award of Contract/Notice to Proceed	March, 2017
B. Substantial Completion (Beneficial Occupancy of the entire project)	September 22, 2017
C. Final Completion	September 29, 2017

4.5 Should the Contractor fail to substantially complete the Work on or before the date stipulated as a Milestone Date in Article 4.3 above, or for Substantial Completion (or such later date as may result from an extension of time granted by the Owner), he shall pay the Owner, as liquidated damages, the sum of **\$100** for each consecutive calendar day that terms of the contract remain unfulfilled beyond the date allowed by the Contract, which sum is agreed upon as a reasonable and proper measure of damages which the Owner will sustain per day by failure of the Contractor to complete within time as stipulated; it being recognized by the Owner and the Contractor that the injury to the Owner which could result from a failure of the Contractor to complete on schedule is uncertain and cannot be computed exactly. In no way shall cost for liquidated damages be construed as a penalty on the Contractor.

4.6 For each consecutive calendar day that the Work remains incomplete after the date established for Final Completion, the Owner will retain from the compensation otherwise to be paid to the Contractor the sum of **\$500**. This amount is the minimum measure of damages the Owner will sustain as a failure of the Contractor to complete all remedial work, correct deficient work, clean up the project and other miscellaneous tasks as required to complete all work specified. This amount is in addition to the liquidated damages prescribed above and represents compensation for additional costs the Owner could incur or suffer caused by on-going construction while school may or may not be in progress. Such costs include, but are not limited to, additional security and safety measures for students, employee overtime, split shift for school, additional busing, insurance and like costs.

4.7 The amount of liquidated damages set forth in Articles 4.4 and 4.5 hereinabove shall be assessed cumulatively. The items of cost included in the assessment of liquidated damages are as defined in the General Conditions.

Article 5

CONTRACT SUM

- 5.1 Provided that the Contractor shall strictly and completely perform all of its obligations under the Contract Documents, and subject only to additions and deductions by Modification or as otherwise provided in the Contract Documents, the Owner shall pay to the Contractor, in current funds and at the time and in the installments hereinafter specified, the sum of
\$ _____ herein referred to as the "Contract Sum".

Article 6

PROGRESS PAYMENTS

- 6.1 The Contractor hereby agrees that on or about the First day of the month for every month during the performance of the Work he will deliver to the Design Consultant an Application for Payment in accordance with the provisions of Article 9 of the General Conditions. This date may be changed upon mutual agreement, stated in writing, between the Owner and Contractor. Payment under this Contract shall be made as provided in the General Conditions.

Article 7

OTHER REQUIREMENTS

- 7.1 The Contractor shall submit the Performance Bond, Labor and Material Payment Bond and Certification of Insurance as required by the Contract Documents.
- 7.2 The Owner shall furnish to the Contractor **five (5)** sets of drawings and **five (5)** sets of specifications, at no extra cost, for use in the Construction of the Work. Additional sets of drawings or specifications may be obtained by the Contractor by paying the Owner for the costs of reproduction, handling and mailing.
- 7.3 The Contractor shall perform at least twenty-five percent (25%) of the total Work with forces that are in the direct employment of the Contractor's organization.

IN WITNESS WHEREOF, **St. Johns County School District** (hereinafter called the "Owner") by resolution of its authorized body and directing the same and adopted at a regular meeting thereof, duly called and held in the County of **St. Johns, Florida** on _____ the _____ day of _____ **20**____, has caused these presents to be signed and its corporate seal to be hereunto affixed, attested by its **Superintendent and/or Chairman**, and _____ (hereinbefore called "Contractor") has caused these presents to be signed by its President and its Corporate seal to be hereunto affixed, as hereinafter attested, all as of the day and year first above written.

ST. JOHNS COUNTY SCHOOL DISTRICT

By: _____

Its: _____

(CONTRACTOR)

Name

Title

Attest:

(Seal)

END OF SECTION C
OWNER-CONTRACTOR AGREEMENT

SECTION GC

INDEX

Article 1	Contract Documents
Article 2	The Design Consultant
Article 3	Owner
Article 4	Contractor
Article 5	Subcontractors
Article 6	Work by Owner or By Separate Contractors
Article 7	Miscellaneous Provisions
Article 8	Time
Article 9	Payments and Completion
Article 10	Protection of Persons and Property
Article 11	Insurance
Article 12	Changes in the Work
Article 13	Uncovering and Correction of Work
Article 14	Termination of the Contract

NOTICE OF DISCLAIMER

TAKE NOTICE, that these General Conditions may contain language and Article or Paragraph headings or names which appear similar to or the same as the provisions of the "General Conditions of the Contract for Construction", published by the American Institute of Architects, AIA Document A-201, 1976 Edition.

TAKE NOTICE, however, that these General Conditions are substantially and materially different in many respects from the AIA Document A-201 and that certain additions, deletions or other modifications have been made to provisions similar to those contained in the AIA Document. This document, further, contains provisions which do not appear in the AIA document.

The use of any language or article or paragraph format similar to or the same as AIA Document A-201 does not constitute an endorsement by the American Institute of Architects of this document.

GENERAL CONDITIONS OF THE
CONTRACT FOR CONSTRUCTION

TABLE OF ARTICLES

1.	CONTRACT DOCUMENTS	9.	PAYMENTS AND COMPLETION
2.	DESIGN CONSULTANT	10.	PROTECTION OF PERSONS
3.	OWNER AND PROPERTY	11.	INSURANCE
4.	CONTRACTOR	12.	CHANGES IN THE WORK
5.	SUBCONTRACTORS	13.	UNCOVERING AND CORRECTION
6.	WORK BY OWNER OR BY SEPARATE CONTRACTORS OF WORK	14.	TERMINATION OF THE CONTRACT
7.	MISCELLANEOUS PROVISIONS		
8.	TIME CONTRACT		

ARTICLE 1
CONTRACT DOCUMENTS

1.1 DEFINITIONS

1.1.1 THE CONTRACT DOCUMENTS

The Contract Documents consist of the Owner-Contractor Agreement, the Conditions of the Contract (General, Supplementary and other Conditions), the Performance and Labor and Material Payment Bonds, Bid Bond, the Drawings, the Specifications, and all Addenda issued prior to and all Modifications issued after execution of the Contract. A Modification is (1) a written amendment to the Contract signed by both parties, (2) a Change Order issued pursuant to the provisions of Article 12.1, (3) a written order for a minor change in the Work issued by the Design Consultant pursuant to Paragraph 12.5. The Contract documents include Bidding Documents such as the Advertisement or Invitation to Bid, the Instructions to Bidders, sample forms, the Contractor's Bid or portions of Addenda relating to any of these. The Contract Documents do not include any other documents including but not limited to soils, geotechnical or other reports, boundary or other surveys and analyses, which may be printed, bound or assembled with the contract documents, or otherwise made available to the Contractor for review or information under this Contract, unless specifically enumerated and expressly incorporated by reference in the Owner-Contractor Agreement.

- 1.1.1.1 The Drawings and Specifications referred to in the Contract Documents have been prepared by **Prosser, Inc.** (Design Consultant) and are identified as **St. Johns County School District Pavement Rehabilitation (2017)**.

1.1.2 THE CONTRACT

The Contract is the sum of all the Contract Documents. This Contract represents the entire and integrated agreement between the Owner and the Contractor and supersedes all prior negotiations, representations, or agreements, either written or oral. The Contract may be amended or modified only by a Modification as defined in Subparagraph 1.1.1 and notwithstanding anything contained in the Contract Documents to the contrary, there can be no increase in the Contract Sum or Time without an executed change order.

1.1.3 THE WORK

The Work comprises the completed construction required by the Contract Documents and includes all labor, supplies and other facilities or things necessary to produce such construction, and all materials, equipment, and supplies incorporated or to be incorporated in such construction.

1.1.4 THE PROJECT

The Project is the total construction of which the Work performed under the Contract Documents may be the whole or a part.

1.1.5 FURNISH, INSTALL, PROVIDE:

The terms "Furnish" or "Install" or "Provide", unless specifically limited in context, mean: Furnishing and incorporating a specified item, product or material in the work, including all necessary labor, materials, equipment to perform the work required, ready for use.

1.1.6 NOTICE

The term "Notice" as used herein shall mean and include written notice. Written notice shall be deemed to have been duly served when delivered to or at the last known business address of the person, firm or corporation for whom intended, or to his, their or its duly authorized agent, representative or officer; or when enclosed in a postage prepaid wrapper or envelope addressed to such person, firm or corporation at his, their or its last known business address and deposited in a United States mailbox.

1.1.7 MISCELLANEOUS WORDS OR TERMS

Whenever they refer to the work or its performance, "Directed", "Required", "Permitted", "Ordered", "Designated", "Prescribed", and words of like import shall imply the direction, requirements, permission, order, designation or prescription of the Owner, Construction Program Manager or Design Consultant, and "Approved", "Acceptable", "Satisfactory", "in the judgment of" and words of like import shall mean approved by or acceptable to or satisfactory to, in the judgment of the Owner.

- 1.1.8 **BIDDER:** Any individual, company, corporation, partnership, or joint venture who submits a bid for work required as distinct from a sub-bidder who submits a bid to a prime bidder.
- 1.1.9 **BIDDING DOCUMENTS:** The Invitation to Bid, Contractor's Qualification Statement, Instructions to Bidders, Sample Forms, Proposal, Specifications, Drawings and Addenda issued prior to receipt of bids.
- 1.1.10 **DIRECTED, REQUIRED, ACCEPTABLE:** When these words refer to work or its performance, "directed," "required," "permitted," "ordered," "designated," "prescribed," and words of like implication, mean "by direction of," "requirements of," "permission of," "order of," "designation of," or "prescription of" the Architect. Likewise, "acceptable," "satisfactory," "in the judgement of," and words of like import, mean "recommended by," "acceptable to," "satisfactory to," or "in the judgement of" the Architect.
- 1.1.11 **AS SHOWN, AS INDICATED, AS DETAILED:** These words, and words of like implication, refer to information contained by drawings describing the work, unless explicitly stated otherwise in other Contract Documents.
- 1.1.12 **MANUFACTURER:** An individual, company, or corporation who manufactures, fabricates, or assembles a standard product. A standard product is one that is not made to special design, and if furnished by either direct sale or by contract to the Contractor, Subcontractor or Vendor.
- 1.1.13 **MATERIAL SUPPLIER OR VENDOR:** A person or organization who supplies, but who is not responsible for the installation of, materials, products and equipment of a standard nature that are not specifically fabricated for this particular contract.
- 1.1.14 **PLANS OR DRAWINGS:** All drawings or reproduction of drawings pertaining to required work.
- 1.1.15 **PRODUCT:** The term 'product' includes materials, systems and equipment.
- 1.1.16 **PROJECT MANUAL:** The Project Manual includes the bidding requirements, Conditions of Contract and the specifications. Not all documents bound in the Manual are necessarily Contract Documents as described in Paragraph 1.1.1.
- 1.1.17 **PROPOSAL:** A complete and properly signed document whereby a bidder proposes to do the work or designated portion thereof for the sums stipulated therein, supported by data called for by the bidding requirements.
- 1.1.18 **PROVIDE:** As a directive to the Contractor, "provide" means "furnish and install completely".

1.1.19 SPECIFICATIONS: Descriptions, provisions and requirements, pertaining to method and manner of performing work, or to quantities and qualities of materials to be furnished under terms of the Contract.

1.2 EXECUTION, CORRELATION AND INTENT

1.2.1 The Contract Documents shall be signed in not less than quadruplicate by the Owner and Contractor and each of which shall be deemed an original, but all of which shall constitute one and the same instrument. If either the Owner or the Contractor or both do not sign the Contract Documents, then they shall be as described in Paragraph 1.1.1 and shall be identified by the Construction Project Manager.

1.2.2 By executing the Contract, the Contractor represents that he has visited the site, familiarized himself with the local conditions under which the Work is to be performed, and correlated his observations with the requirements of the Contract Documents. Contractor further represents that all Design Drawings and specifications contain some minor errors and discrepancies. Such errors and discrepancies shall not form the basis of any claim by Contractor for defective design or breach of any implied warranties as to fitness of plans or specifications against Owner.

1.2.3 The intent of the Contract Documents is to include all items necessary for the proper execution and completion of the Work. The Contract Documents are complementary, and what is required by any one shall be as binding as if required by all. Performance by the Contractor shall be required only to the extent consistent with the Contract Documents and reasonably inferable from them as being necessary to produce the intended results. Words and abbreviations which have well-known technical or trade meanings are used in the Contract Documents in accordance with such recognized meanings unless otherwise specifically defined herein. The table of contents, index, titles, headings, running headlines and marginal notes contained herein and in said documents are solely to facilitate reference to various provisions of the Contract Documents and in no way affect, limit or cast light upon the interpretation of the provisions to which they refer.

1.2.4 The organization of the Specifications into divisions, sections and articles, and the arrangement of Drawings is for clarity only, and shall not control the Contractor in dividing the work among Subcontractors or in establishing the extent of Work to be performed by any trade. The Contractor may subcontract the Work in such divisions as he sees fit and he is ultimately responsible for furnishing all work shown on the drawings and/or in the specifications.

1.2.5 Anything shown on the drawings and not mentioned in the specifications or mentioned in the specifications and not shown on the drawings shall have the same effect as if shown or mentioned respectively in both. Technical specifications take priority over general specifications and detail drawings take precedence over general drawings. Any work shown on one drawing shall be construed to be shown in all drawings and the contractor will coordinate the work and the drawings. If any portion of the

Contract Documents shall be in conflict with any other portion, the various documents comprising the Contract Documents shall govern in the following order of precedence: The Owner- Contractor Agreement; Modifications; Addenda; any Supplementary Conditions; the General Conditions; the Specifications; the Drawings; as between schedules and information given on Drawings, the schedules shall govern; as between figures given on Drawings and the scaled measurements, the figures shall govern; as between large-scale Drawings and small scale Drawings, the larger scale shall govern. Any such conflict or inconsistency between or in the drawings shall be submitted to the Design Consultant whose decision thereon shall be final and conclusive.

- 1.2.6 The Contractor agrees that nothing contained in the Contract Documents or any contract between the Owner and the Construction Program Manager or the Owner and the Design Consultant shall create any contractual relationship between the Construction Program Manager and the Contractor, the Design Consultant and the Contractor, the Design Consultant and the Construction Program Manager or between the Owner, Design Consultant, and the Construction Program Manager and any Subcontractor or Sub-subcontractors. The Contractor acknowledges and agrees that this Contract is not intended to create, nor shall any provision be interpreted as creating, any contractual relationship between the Owner or Contractor and any third parties.
- 1.2.7 The provisions of this Contract cannot be amended, modified, varied or waived by the Owner or its agents or representatives in any respect except by a Modification approved and executed by the **St. Johns County School District**. The Contractor is hereby given notice that no person has authority to orally waive, or to release the Contractor from any of the Contractor's duties or to alter obligations under or arising out of this Contract. Any waiver, approval or consent granted by Modification to the Contractor shall be limited to those matters specifically and expressly stated thereby to be waived, approved or consented to and shall not relieve the Contractor of the obligation to obtain any future waiver, approval or consent.
- 1.2.8 Any material or operation specified by reference to published specifications of a manufacturer, a society, an association, a code, or other published standard, shall comply with requirements of the listed document which is current on date of receipt of bids. In case of a conflict between referenced document and project specifications, project specifications shall govern. In case of a conflict between referenced documents, the one having more stringent requirements shall govern.
- 1.2.9 The Contractor, if requested, shall furnish an affidavit from manufacturer certifying that materials or product delivered to job meets requirements specified.
- 1.3 OWNERSHIP AND USE OF DOCUMENTS
- 1.3.1 All Drawings, Specifications and copies thereof furnished by the Design Consultant are and shall remain his property. They are to be used only with respect to this Project and are not to be used on any other project. With the exception of one contract set for each party to the Contract, such documents are to be returned or suitably accounted for

to the Design Consultant on request at the completion of the Work. Submission or distribution to meet official regulatory requirements or for other purposes in connection with the Project is not to be construed as publication in derogation of the Design Consultant's common law copyright or other reserved rights.

- 1.3.1.1 The Contractor will be furnished with the following quantities of drawings and specifications free. Additional copies will be provided at cost.

General Contractor 5 sets

END OF ARTICLE 1

ARTICLE 2
THE DESIGN CONSULTANT

2.1 DEFINITIONS

- 2.1.1 The terms "Design Consultant" or "A/E" or "Architect" or "Engineer" as used or set forth in the Contract Documents, shall mean the entity and its consulting firm or agencies, or their duly authorized representatives, that is responsible for designing or engineering the work, and performing the activities specified herein, as identified in the Owner-Contractor Agreement, including any consulting-engineers or subcontractors to said entity or firm. Such firm or agency and its representatives shall act severally within the scope of particular duties entrusted to them, unless otherwise provided for in the Contract.

- 2.1.2 The Design Consultant is identified in the Owner-Contractor Agreement and is referred to throughout the Contract Documents as if singular in number and masculine in gender. The Design Consultant is further described as and, throughout this document, shall mean one or both of the following:

- 2.1.2.1 ARCHITECT, a person or other legal entity lawfully licensed to practice architecture in the state wherein the Project is located; or

- 2.1.2.2 ENGINEER, a person or other legal entity lawfully licensed to practice engineering in the state wherein the Project is located.

- 2.1.3 DESIGN CONSULTANT: **Prosser, Inc., 13901 Sutton Park Drive South, Suite 200, Jacksonville, FL 32224-0229.**

2.2 SERVICES OF THE DESIGN CONSULTANT

- 2.2.1 The Design Consultant will provide certain services as hereinafter described.

- 2.2.2 Should errors, omissions, or conflicts in the Drawings, Specifications, or other Contract Documents prepared by the Design Consultant be discovered, the Design Consultant will prepare such amendments or supplementary documents and provide consultation as may be required.
- 2.2.3 The Design Consultant will visit the site at intervals appropriate to the stage of construction to familiarize itself generally with the progress and quality of the Work and to determine in general if the Work is proceeding in accordance with the Contract Documents. The Design Consultant will not be required to make exhaustive or continuous on-site inspections to check the quality or quantity of the Work, but it shall make as many inspections as may reasonably be required to fulfill its obligations to the Owner. On the basis of such on-site observations, the Design Consultant and his consulting engineers shall endeavor to guard the Owner against defects and deficiencies in the Work of the Contractor.
- 2.2.4 The Design Consultant will render written field reports to the Construction Program Manager in the form required by the Construction Program Manager relating to the periodic visits and inspections of the Project required by Subparagraph 2.2.3.
- 2.2.5 The Design Consultant will not be responsible for and will not have control or charge of construction means, methods, techniques, sequences or procedures, or for safety precautions and programs in connection with the Work, and he will not be responsible for the Contractor's failure to carry out the Work in accordance with the Contract Documents. The Design Consultant will not be responsible for or have control or charge over the acts or omissions of the Contractor, Subcontractors, or any of their agents or employees, or any other persons performing any of the Work.
- 2.2.6 The Design Consultant shall at all times have access to the work wherever it is in preparation or progress. The Contractor shall provide safe facilities for such access so the Design Consultant may perform his functions under the Contract Documents.
- 2.2.7 As required, the Design Consultant will render to the Construction Program Manager, within a reasonable time, interpretations concerning the design and other technical aspects of the Work and the Contract Documents.
- 2.2.8 All communications, correspondence, submittals, and documents exchanged between the Design Consultant and the Contractor in connection with the Project shall be through or in the manner prescribed by the Construction Program Manager.
- 2.2.9 All interpretations and decisions of the Design Consultant shall be consistent with the intent of and reasonably inferable from the Contract Documents.
- 2.2.10 The Design Consultant's decisions in matters relating to artistic effect will be final if consistent with the intent of the Contract Documents.

- 2.2.11 If the Design Consultant observes any Work that does not conform to the Contract Documents, the Design Consultant shall report this observation to the Contractor and Construction Program Manager. The Design Consultant will prepare and submit to the Contractor and Construction Program Manager "an inspection report" of the Contractor's Work which is not in conformance with the Contract Documents. The Design Consultant shall have a reasonable time to complete his inspection report for substantial and final completion. Contractor shall, upon receipt of the inspection report, cause the defective, omitted or non-conforming work listed in the inspection report to be corrected and/or completed. Contractor shall further cause the person or entity performing the corrective work to sign the inspection report adjacent to the listed item, which signature shall attest to the completion or correction of the listed item. After Contractor has completed and corrected all items listed in the inspection report, Contractor shall, in writing, call for final inspection. Design Consultant shall have a reasonable time within which to conduct the final inspection. In the event Design Consultant determines that one or more of the items required for completion of the work (whether listed in the inspection report referenced above or not) remain incomplete or uncorrected, then in such event, Contractor shall be responsible for and liable to the Owner for any and all additional design or construction inspection costs associated with the completion of the project. It is the intent of this paragraph that Owner shall be responsible for the costs associated with one inspection to determine substantial completion and one additional inspection to determine final completion. All additional design or inspection costs shall be deducted from Contractor's final pay estimate and Contractor, by execution of this Contract, hereby consents to same.
- 2.2.12 The Design Consultant has the authority to condemn or reject work on behalf of the Owner when, in its opinion, the work does not conform to the Contract Documents. Whenever, in the Design Consultant's reasonable opinion, it is considered necessary or advisable for the implementation of the intent of the Contract Documents, the Design Consultant will have the authority to require special inspection or testing of the work in accordance with the provisions of the Contract Documents whether or not such work be then fabricated, installed or completed.
- 2.2.13 The Design Consultant will review Contractor's submittals such as Shop Drawings, Product Data and Samples, but only for conformance with the design concept of the Work and for general compliance with the Contract Documents. Such action shall be taken within fourteen (14) days of receipt unless otherwise authorized by the Construction Program Manager.
- 2.2.14 The Construction Program Manager will establish with the Design Consultant procedures to be followed for review and processing of all Shop Drawings, catalog submittals, project reports, test reports, maintenance manuals, and other necessary documentation, as well as requests for changes and applications for extensions of time.
- 2.2.15 The Design Consultant will prepare Change Orders as required under the Contract Documents.

- 2.2.16 The Design Consultant and the Construction Program Manager will conduct inspections to determine the dates of Substantial Completion and Final Completion, and will jointly issue a final Certificate for Payment. The Design Consultant shall be solely responsible for issuance of Certificates of Substantial and Final Completion.
- 2.2.17 The Design Consultant will prepare a set of reproducible record prints of Drawings showing significant changes in the Work made during the construction process, based on neatly and clearly marked-up prints, Drawings, and other data furnished by the Contractor. The Design Consultant will also provide the Owner assistance in the original operation of any equipment or system such as initial start-up, testing, adjusting, and balancing.
- 2.2.18 In case of the termination of the employment of the Design Consultant, the Owner may appoint a new Design Consultant whose status under the Contract Documents shall be that of the former Design Consultant, or the Owner may have the Construction Program Manager assume all of the services of the Design Consultant thereafter.

END OF ARTICLE 2

ARTICLE 3

OWNER

3.1 DEFINITION

3.1.1 The Owner is the person or entity identified as such in the Owner-Contractor Agreement and is referred to throughout the Contract Documents as if singular in number and masculine in gender.

3.1.2 Owner: **St. Johns County School District
40 Orange Street
St. Augustine, Florida 32084**

3.2 CONSTRUCTION PROGRAM MANAGER

3.2.1 **Prosser, Inc.** (herein referred to as the Construction Program Manager will assist and advise the Owner during Project construction and until the issuance of the final Certificate for Payment. The term Construction Program Manager is referred to throughout the Contract Documents as if singular in number and masculine in gender. The Owner's communications with the Contractor and the Design Consultant shall generally be through the Construction Program Manager, who will assist the Owner with regard to the Project. The Owner must approve all Change Orders and payments to the Contractor and, notwithstanding anything in the Contract Documents to the contrary, neither the Design Consultant nor Construction Program Manager shall have any authority to authorize or issue change orders. All of the Contractor's

communications to the Owner or to the Design Consultant shall be exclusively through the Construction Program Manager.

3.2.2 The Construction Program Manager is not authorized to revoke, alter, change, relax, or release any requirements of the Contract, nor to approve or accept any portion of the Work not executed in accordance with, nor to issue instructions contrary to, the Contract Documents.

3.3 INFORMATION, SERVICES AND RIGHTS OF THE OWNER

3.3.1 The Construction Program Manager, will provide administration of the Contract as hereinafter described.

3.3.2 The Owner and the Construction Program Manager shall at all times have access to the Work whenever it is in preparation or progress. The Contractor shall provide safe facilities for such access.

3.3.3 The Owner and the Construction Program Manager shall not be responsible for or have control or charge of the construction means, methods, techniques, sequences, or procedures, or for safety precautions and programs in connection with the Work, and will not be responsible for the Contractor's failure to carry out the Work in accordance with the Contract Documents.

3.3.4 The Construction Program Manager or Design Consultant will have authority to require special inspection or testing of the work in accordance with Subparagraph 2.2.12 whether or not such Work be then fabricated, installed, or completed. However, neither the Construction Program Manager's authority to act under Subparagraph 3.3.4, nor any decision made by the Construction Program Manager in good faith either to exercise or not to exercise such authority shall give rise to any duty or responsibility of the Construction Program Manager to the Contractor, any Subcontractor, any of their agents or employees, or any other person performing any of the Work.

3.3.5 The Construction Program Manager shall have the authority and discretion to call, schedule, and conduct job meetings to be attended by the Contractor, representatives of his Subcontractors, and the Design Consultant, to discuss such matters as procedures, progress, problems, and scheduling.

3.3.5.1 Each Contractor is requested and required to attend monthly job site progress conferences as called by the Architect. Contractor shall be represented at these job progress conferences by an authoritative representative of the home office of the Contractor as well as by project personnel representatives. These meetings shall be open to subcontractors, material suppliers, and any others who can contribute shall be encouraged by Contractor to attend. It shall be the principal purpose of these meetings, or conferences, to affect coordination, cooperation and assistance in every practical way toward the end of maintaining progress of the project on schedule and to complete the project within the specified Contract Time. Each Contractor shall be

prepared to assist progress of the work and to recommend remedial measures for the correction of progress as may be appropriate. The Construction Program Manager shall be the coordinator of the conferences and shall preside as chairman.

- 3.3.6 The Construction Program Manager will establish procedures to be followed for processing all Shop Drawings, catalogs, and other project reports, and other documentation, test reports, and maintenance manuals.
- 3.3.7 The Design Consultant will review all requests for changes and Design Consultant shall implement the processing of Change Orders, including applications for extension of the Contract Time.
- 3.3.8 The Owner and the Construction Program Manager, however, will not be responsible for the failure of the Contractor to plan, schedule, and execute the Work in accordance with the approved schedule or the failure of the Contractor to meet scheduled completion dates or the failure of the Contractor to schedule and coordinate the Work of his own trades and Subcontractors or to coordinate and cooperate with other separate contractors.
- 3.3.9 The Construction Program Manager, in consultation with the Design Consultant, will review and process all Applications for Payment by the Contractor, including the final Application for Payment.
- 3.3.10 The Owner, Construction Program Manager and Design Consultant shall not be responsible or liable to Contractor for the acts, errors or omissions of the Contractor, any separate Subcontractor, any separate contractor or any contractor's or subcontractor's agents or employees, or any other persons performing any of the Work.
- 3.3.11 The Owner shall furnish all surveys describing the physical characteristics, legal limitations and utility locations for the site of the Project. Such documents are not part of the Contract Documents and are provided for Contractor's information only.
- 3.3.12 The Owner shall secure and pay for necessary easements, required for permanent structures or for permanent changes in existing facilities.
- 3.3.13 Unless otherwise provided in the Contract Documents, the Contractor will be furnished, free of charge, all copies of Drawings and Specifications reasonably necessary for the execution of the Work.
- 3.3.14 The Owner will make available for the Contractor's reasonable review, at the Owner's offices or together with the Contract Documents, certain boring logs, geotechnical, soils and other reports, surveys and analyses pertaining to the Contract site of which the Owner is aware and has in its possession. Any boring logs that are provided to the Contractor are only intended to reflect conditions at the locations of the borings and do not necessarily reflect site conditions at other locations. Any reports, surveys, boring logs and analyses provided by Owner are for the Contractor's information only, and

their accuracy and completeness are not guaranteed or warranted by the Owner, the Construction Program Manager or the Design Consultant, and such reports are not adopted by reference into, nor are they part of the Contract Documents. Notwithstanding any factual statement, conclusion, or any language or recommendations contained in such reports, the Contractor assumes full responsibility for inspection of the site and determination of the character, legal limits, quality and quantity of any soil, surface or subsurface conditions that may be encountered or which may affect the Work, and for the means and methods of construction that he employs when performing the Work.

3.3.15 The foregoing rights are in addition to other rights of the Owner enumerated herein and those provided by law.

3.4 OWNER'S RIGHT TO STOP OR TO SUSPEND THE WORK

3.4.1 If the Contractor fails to correct defective Work as required by Paragraph 13.2 or fails to carry out the Work or supply labor and materials in accordance with the Contract Documents, the Construction Program Manager by a written order may order the Contractor to stop the Work, or any portion thereof, until the cause for such order has been eliminated; however, this right of the Construction Program Manager to stop the Work on behalf of the Owner shall not give rise to any duty on the part of the Construction Program Manager to exercise this right for the benefit of the Contractor or any person or entity other than the Owner.

3.4.2 The Construction Program Manager may order the Contractor in writing to suspend, delay, or interrupt all or any part of the Work for such period of time as he may determine to be appropriate for the convenience of the Owner.

3.4.3 If the performance of all or any part of the Work is, for an unreasonable period of time, suspended, delayed, or interrupted by an act of the Owner, the Construction Program Manager, or the Design Consultant in the administration of this Contract, or by failure of any one of them to act within the time specified in this Contract (or if no time is specified, within a reasonable time), an adjustment shall be made for an increase in the actual time required for performance of the Work by the Contractor, due solely to such unreasonable suspension, delay, or interruption and the Contract modified in writing accordingly. However, no claim for an extension of time shall be made under this Subparagraph 3.4.3 for any suspension, delay, or interruption pursuant to Subparagraph 3.4.1, or for which claim is provided or excluded under any other provision of this Contract. No claim under this Subparagraph shall be allowed for an extension of time required for performance, unless within 20 days after the act or failure to act involved, the Contractor submits to the Construction Program Manager a written statement setting forth, as then practicable, the extent of such claimed time extension and unless the claim for an extension of time is asserted in writing as soon as practicable after the termination of such suspension, delay, or interruption, and unless such delay actually delayed critical work activities on the project. Any time extension

granted shall only be for the unreasonable portion of the delay to critical work activities and in accordance with Article 8 hereof.

3.4.4 In the event of a suspension of work or delay or interruption of work per Article 3.4.3, the Contractor will and will cause his subcontractors to protect carefully his, and their, materials and work against damage or injury from the weather and maintain completed and uncompleted portions of the work as required by the Contract Documents. If, in the opinion of the Construction Program Manager, any work or material shall have been damaged or injured by reason of failure on the part of the Contractor or any of his subcontractors to so protect same, such work and materials shall be removed and replaced at the expense of the Contractor.

3.4.5 No claim by the Contractor for an equitable adjustment under Subparagraph 3.4.3 shall be allowed if asserted after final payment under this Contract.

3.5 OWNER'S RIGHT TO CARRY OUT THE WORK

3.5.1 If the Contractor defaults or neglects to carry out the Work in accordance with the Contract Documents and fails within seven days after receipt of written notice from the Construction Program Manager, with a copy of such notice sent to the Contractor's surety, to commence and continue correction of such default or neglect with diligence and promptness, the Owner may, after seven days following receipt by the Contractor of an additional written notice and without prejudice to any other remedy he may have, make good such deficiencies and may further elect to complete all Work thereafter through such means as the Owner may select, including the use of a new contractor pursuant to Article 3.5.2. In such case the Owner shall provide notice to the Contractor's surety and an appropriate Change Order shall be issued deducting from the payments then or thereafter due the Contractor the cost of correcting such deficiencies, including compensation for the Design Consultant's and the Construction Program Manager's additional services made necessary by such default, neglect or failure. Such action by the Owner and the amount charged to the Contractor are both subject to the prior approval of the Construction Program Manager and the Design Consultant. If the payments then or thereafter due the Contractor are not sufficient to cover such amount, the Contractor shall pay the difference to the Owner. Notwithstanding the Owner's right to carry out a portion of the work, maintenance and protection of the work remains the Contractor's and Surety's responsibility as provided for in the Performance Bond and Guarantee of Contractor.

3.5.2 Whenever Contractor shall be, and is declared by Owner to be, in default under the Contract the Owner having performed Owner's obligations thereunder, the Surety shall promptly remedy the default, or shall promptly

- 1) Complete the Contract in accordance with its terms and conditions, or,
- 2) Obtain a bid or bids for completing the Contract in accordance with its terms and conditions upon determination by the Owner and the Surety jointly of the

lowest responsible bidder, arrange for a contract between such bidder and Surety to complete the Work and provide any required warranty work on service.

END OF ARTICLE 3

ARTICLE 4

CONTRACTOR

4.1 DEFINITION

4.1.1 The Contractor is the person or organization identified as such in the Owner-Contractor Agreement and is referred to throughout the Contract Documents as if singular in number and masculine in gender. The term Contractor means the Contractor or his authorized representative, who shall have authority to bind the Contractor in all matters pertinent to this Contract.

4.1.2 This entire Contract is not one of agency by the Contractor for Owner but one in which Contractor is engaged independently in the business of providing the services and performing the Work herein described as an independent contractor.

4.2 REVIEW OF CONTRACT DOCUMENTS

4.2.1 Before placing his proposal to the Owner, and continuously after execution of the Contract, the Contractor shall carefully study and compare the Contract Documents and shall at once report to the Owner through the Construction Program Manager and Design Consultant any error, inconsistency or omission he may discover, including any requirement which may be contrary to any law, ordinance, rule, regulation or order of any public authority bearing on the performance of the Work. If the Contractor has reported in writing an error, inconsistency or omission, has promptly stopped the affected work until otherwise instructed, and has otherwise followed the instructions of the Owner, the Contractor shall not be liable to the Owner or the Design Consultant for any damage resulting from any such errors, inconsistencies or omissions in the Contract Documents. The Contractor shall perform no portion of the Work at any time without being awarded the Contract and receiving a Notice to Proceed under these Contract Documents, and, where required, possessing approved Shop Drawings, Product Data or Samples for such portion of the Work.

4.2.2 The Contractor and his Subcontractors shall keep at the site of the Work at least one copy of the drawings and specifications and shall at all times give the Construction Program Manager, the Design Consultant, inspectors, as well as other representatives of the Owner access thereto. Further, said drawings shall be the approved sets issued to the Contractor by the Owner through the Construction Program Manager.

4.3 SUPERVISION AND CONSTRUCTION PROCEDURES

- 4.3.1 The Contractor shall supervise and direct the Work, using his best skill and attention. He shall be solely responsible for and have control over all construction means, methods, techniques, sequences and procedures of construction and for coordinating all portions of the Work under the Contract.
- 4.3.1.1 It shall be the responsibility of the Contractor to coordinate the work with other Prime Contractors; to maintain a progress schedule for all Prime Contractors for this project; and to notify the designer of any changes in the progress schedule. He shall be responsible for providing adequate notice to all Prime Contractors to insure efficient continuity of all phases of the project work. Each other Prime Contractor is held responsible for keeping the Contractor fully informed as to his work progress, including immediate notification of any work progress changes.
- 4.3.2 The Contractor shall be responsible to the Owner for the acts and omissions of his employees, Subcontractors and Sub-subcontractors, suppliers, their agents and employees, and other persons performing any of the Work and for their compliance with each and every requirement of the Contract Documents, in the same manner as if they were directly employed by the Contractor.
- 4.3.3 The Contractor shall not be relieved from his obligations to perform the Work in accordance with the Contract Documents either by the acts, failures to act or duties of the Owner, the Design Consultant or the Construction Program Manager in their administration of the Contract, or by inspections (or lack thereof), tests or approvals (or lack thereof) required or performed under Paragraph 7.6 by persons other than the Contractor.
- 4.3.4 Before starting any section of work, the Contractor shall carefully examine all preparatory work that has been executed to receive his work to see that it has been completed in accordance with the Contract Documents. He shall check carefully, by whatever means are required, to ensure that his Work and adjacent, related work will finish to proper and required standards for quality, contours, planes, and levels.
- 4.3.5 The Contractor understands and agrees that the Owner, Construction Program Manager and Design Consultant will not be responsible for and will not have control or charge of construction means, methods, techniques, sequences or procedures, or for safety precautions and programs in connection with the Work, and they will not be responsible for the Contractor's failure to carry out the Work in accordance with the Contract Documents. The Owner, Construction Program Manager and the Design Consultant will not be responsible for or have control or charge over the acts or omissions of the Contractor, Subcontractors, or any of their agents or employees, or any other persons performing any of the Work.
- 4.3.6 The Contractor shall employ no plant, equipment, materials, methods or persons to which the Construction Program Manager and Design Consultant have a reasonable

objection and shall remove no portion of the Work or stored materials from the site of the Work.

4.4 CONTRACTOR'S REPRESENTATIONS

4.4.1 By entering into this Contract with the Owner, the Contractor represents and warrants the following, together with all other representations and warranties in the Contract Documents:

- .1 that he is experienced in and competent to perform the type of work required and to furnish the plant, materials, supplies or equipment to be so performed or furnished by him;
- .2 that he is financially solvent, able to pay his debts as they mature, and possessed of sufficient working capital to initiate and complete the Work required under the Contract;
- .3 that he is familiar with all Federal, State, County, municipal and department laws, ordinances, permits, regulations and resolutions which may in any way affect the Work or those employed therein, including but not limited to any special laws or regulations relating to the Work or any part thereof;
- .4 that such temporary and permanent work required by the Contract Documents which is to be done by him will be satisfactorily constructed and fit for use for its intended purpose and that such construction will not injure any person, or damage any property;
- .5 that he has carefully examined the Contract Documents and the site of the Work and that from his own investigations, he has satisfied himself and made himself familiar with: **(1)** the nature and location of the Work; **(2)** the character, legal limits, quality and quantity of surface and subsurface materials likely to be encountered, including, but not limited to, all structures and obstructions on or at the project site, both natural and man-made; **(3)** the character of equipment and other facilities needed for the performance of the Work; **(4)** the general and local conditions including without limitation its climatic conditions, the availability and cost of labor and the availability and cost of materials, tools and equipment; **(5)** the quality and quantity of all materials, supplies, tools, equipment, labor and professional services necessary to complete the work in the manner required by the Contract Documents; and **(6)** all other matters or things which could in any manner affect the performance of the Work;
- .6 that he will fully comply with all requirements of the Contract Documents;
- .7 that he will perform the Work consistent with good workmanship, sound business practice, and in the most expeditious and economical manner consistent with the best interests of the Owner;

- .8 that he will furnish efficient business administration and experienced superintendence and an adequate supply of workmen, equipment, tools and materials at all times;
- .9 that he has carefully reviewed the Work required and that the Work can be planned and executed in a normal and orderly sequence of Work and reasonably scheduled so as to ensure completion of the work in accordance with the Contract Documents, allowing for normal and reasonably foreseeable weather, labor and other delays, interruptions and disruptions of the Work;
- .10 that he will complete the Work within the Contract Time and all portions thereof within any required Contract milestones; and
- .11 that his Contract price is based upon the labor, materials, systems and equipment required by or reasonably inferable from the Contract Documents, without exception.

4.5 LABOR AND MATERIALS

- 4.5.1 Unless otherwise provided in the Contract Documents, the Contractor shall provide and pay for all labor, materials, equipment, supplies, tools, construction equipment and machinery, water, heat, utilities, transportation, and other facilities and services necessary or proper for or incidental to the execution and completion of the Work required by and in accordance with the Contract Documents and any applicable code or statute, whether specifically required by the Contract Documents or whether their provision may reasonably be inferred as necessary to produce the intended results, whether temporary or permanent and whether or not incorporated or to be incorporated in the Work. Final payment will not be made until the Work is so completed. The Contractor hereby acknowledges that its bid price is not based upon any claim to the land, timber, soils or other resources at the Construction site, except to the use of soils for necessary site work.
- 4.5.2 The Contractor shall at all times enforce strict discipline and good order among his employees and shall not employ on the Work any unfit subcontractor or person or anyone not skilled in the task assigned to him. The Owner may, by notice in writing, require the Contractor to remove from the work any subcontractor or employee the Owner deems incompetent, careless or otherwise objectionable and Contractor shall provide for this contingency in his Subcontracts.
- 4.5.3 The Contractor shall be responsible for ensuring that the work is completed in a skillful and workmanlike manner.
- 4.5.4 The Contractor shall perform at least that percentage of the Work, if any, specified in Article 7 of the Owner-Contractor Agreement, with forces that are in the direct employment of the Contractor's organization. The Contractor shall submit to the

Construction Program Manager within thirty (30) calendar days after award of the Contract for the Work, a designation of the Work to be performed by the Contractor with his own forces. The percentage of the Work to be performed under subcontract, shall be calculated by adding the amounts of all subcontracts and dividing this sum by the total amount of the Contract. No portion of the Contract shall be subcontracted or otherwise performed by a party not the Contractor, except with the written consent of the Owner.

4.5.5 All equipment, apparatus and/or devices of any kind to be incorporated into the work that are shown or indicated on the drawings or called for in the specifications or required for the completion of the work shall be entirely satisfactory to the Construction Program Manager and the Design Consultant as regards operations, capacity and/or performance. No approval, either written or verbal, of any drawings, descriptive data or samples of such equipment, apparatus and/or device shall relieve the Contractor of his responsibility to turn over the same in good working order for its intended purpose at the completion of the Work in complete accordance with the Contract Documents. Any equipment, apparatus and/or device not fulfilling these requirements shall be removed and replaced by proper and acceptable equipment, etc. or put in good working order satisfactory to the Construction Program Manager and Design Consultant without additional cost to the Owner.

4.6 WARRANTY

4.6.1 The Contractor warrants to the Owner, the Construction Program Manager, and the Design Consultant that all materials and equipment furnished under this Contract will be new unless otherwise specified, and that all workmanship will be of first class quality, free from faults and defects and in conformance with the Contract Documents and all other warranties and guaranties specified therein. Where no standard is specified for such workmanship or materials, they shall be the best of their respective kinds. All Work not conforming to these requirements, including substitutions not properly approved and authorized, may be considered defective. If required by the Construction Program Manager or the Design Consultant, the Contractor shall furnish satisfactory evidence as to the kind and quality of materials and equipment. This warranty is not limited by the provisions of Article 13.

4.6.2 The Work included in this Contract is heretofore specified. The Contractor will be required to complete the Work specified and to provide all items needed for construction of the project, complete and in good order.

4.6.3 The warranties set forth in this Paragraph 4.6 and elsewhere in the Contract Documents shall survive Final Completion of the Work under Paragraph 9.9.

4.6.4 The Contractor and Surety guarantee and warrant to the Owner all work as follows:

.1 that all materials and equipment furnished under this Contract will be new and the best of its respective kind unless otherwise specified;

- .2 that all Work will be of first-class quality and free of omissions and faulty, poor quality, imperfect and defective material or workmanship;
 - .3 that the Work shall be entirely watertight and leak proof in accordance with all applicable industry customs and practices, and shall be free of shrinkage and settlement;
 - .4 that the Work, including but not limited to, mechanical and electrical machines, devices and equipment, shall be fit and fully usable for its intended and specified purpose and shall operate satisfactorily with ordinary care;
 - .5 that consistent with requirements of the Contract Documents the Work shall be installed and oriented in such a manner as to facilitate unrestricted access for the operation and maintenance of fixed equipment; and
 - .6 that the Work will be free of abnormal or unusual deterioration which occurs because of poor quality materials, workmanship or unsuitable storage.
- 4.6.5 All Work not conforming to guarantees and warranties specified in the Contract Documents, including substitutions not properly approved and authorized, may be considered defective. If required by the Design Consultant, the Contractor shall furnish satisfactory evidence as to the kind and quality of materials and equipment.
- 4.6.6 If, within one year after the Date of Final Completion of the Work or within such longer period of time as may be prescribed by law or by the terms of any applicable special warranty required by the Contract Documents, any of the Work is found to be defective, not in accordance with the Contract Documents, or not in accordance with the guarantees and warranties specified in the Contract documents, the Contractor shall correct it within five (5) working days or such other period as mutually agreed, after receipt of a written notice from the Owner to do so. The Owner shall give such notice with reasonable promptness after discovery of the condition.
- 4.6.7 If at any time patent deficiencies in the Work are discovered, the Contractor will be liable for replacement or correction of such Work and any damages which Owner has incurred related thereto, regardless of the time limit of any guarantee or warranty.
- 4.6.8 Any materials or other portions of the Work, installed, furnished or stored on site which are not of the character or quality required by the specifications, or are otherwise not acceptable to the Construction Program Manager, the Design Consultant or the Owner, shall be immediately removed and replaced by the Contractor to the satisfaction of the Construction Program Manager, Design Consultant and Owner, when notified to do so by the Construction Program Manager, Design Consultant or Owner.

4.6.9 If the Contractor fails to correct defective or nonconforming Work as required by Article 4.6.6, or if the Contractor fails to remove defective or nonconforming Work from the site, as required by Article 4.6.8, the Owner may elect to either correct such Work in accordance with Article 3.5 or remove and store materials and equipment at the expense of the Contractor. If the Contractor does not pay the cost of such removal and storage within ten (10) days thereafter, the Owner may upon ten (10) additional days' written notice sell such Work at auction or at private sale and shall account for the net proceeds thereof, after deducting all the costs that should have been borne by the Contractor, including compensation for the Construction Program Manager's and/or the Design Consultant's additional services made necessary thereby. If such proceeds of sale do not cover all costs which the Contractor should have borne, the difference shall be charged to the Contractor and an appropriate Change Order shall be issued. If the payments then or thereafter due the Contractor are not sufficient to cover such amount, the Contractor shall pay the difference to the Owner.

4.6.10 The Contractor shall bear the cost of making good all work of the Owner, separate contractors or others, destroyed or damaged by such correction or removal required under this Article 4, Article 13 or elsewhere in the Contract Documents.

4.7 TAXES

4.7.1 The Contractor shall pay all sales, consumer, use and other similar taxes for the Work or portions thereof provided by the Contractor which are legally enacted at the time bids are received, whether or not yet effective. Owner reserves the right to delete portions of the Work and to direct purchase materials to realize a tax savings. Contractor hereby agrees to permit Owner to direct purchase from his suppliers at prices quoted to Contractor and for Owner to retain any tax savings generated thereby.

4.8 PERMITS, FEES AND NOTICES

4.8.1 Except as specifically provided in Subparagraph 3.3.13, the Contractor shall secure and pay for all permits and governmental fees, licenses and inspections necessary for the proper execution and completion of the Work which are legally required at the time the bids are received. The total cost of the permits will be paid by the Contractor. Each Contractor will pay for his own fees, licenses and inspections for his part of the work. Impact fees, acreage fees and costs for service and service connections of the respective utility will be paid by the Owners.

4.8.2 The Contractor shall give all notices and comply with all laws, ordinances, rules, regulations and lawful orders of any public authority bearing on the performance of the Work.

4.9 ALLOWANCES

4.9.1 The Contractor shall include in the Contract Sum all allowances stated in the Contract Documents. Items covered by these allowances shall be supplied for such amount and

by such persons as the Owner may direct, but the Contractor will not be required to employ persons against whom he makes a reasonable objection.

4.9.2 Unless otherwise provided in the Contract Documents:

- .1 these allowances shall cover the cost to the Contractor, less any applicable trade discount, of the materials and equipment required by the allowance delivered at the site, and all applicable taxes;
- .2 the Contractor's costs for unloading and handling on the site, labor, installation costs, overhead, profit and other expenses contemplated for the original allowance shall be included in the Contract Sum and not in the allowance;
- .3 whenever the cost is more than or less than the allowance, the Contract Sum shall be adjusted accordingly by Change Order, the amount of which will recognize changes, if any, in handling costs on the site, labor, installation costs, overhead, profit and other expense.

4.10 SUPERINTENDENT

4.10.1 The Contractor shall employ a competent superintendent and necessary assistants who shall be in attendance at the Project site during the progress of the Work. The superintendent shall represent the Contractor and all communications given to the superintendent shall be as binding as if given to the Contractor. If the Contractor employs more than a single individual in this role, the Construction Program Manager shall be provided an organizational chart and personnel listing for the superintending staff. In such event, all references to the superintendent elsewhere in the Contract Documents shall mean the superintending staff.

4.10.2 The superintendent shall be in attendance at the Project site not less than eight (8) hours per day, two (2) days per week, unless the job is closed down due to a general strike or conditions beyond the control of the Contractor or until completion or termination of the Contract in accordance with the Contract Documents. It is understood that such Superintendent shall be acceptable to the Owner and the Construction Program Manager and shall be the one who will be continued in that capacity for the duration of the project, unless he ceases to be on the Contractor's payroll or the Owner otherwise agrees. The Superintendent shall not be employed on any other project for or by Contractor or any other entity during the course of the Work.

4.10.3 In the event any of the following conditions shall exist, the Contractor shall require that his superintendent be at the Project site not less than ten (10) hours per day, two (2) days per week:

- .1 should Substantial Completion not be accomplished on schedule.

- .2 should Final Completion not be accomplished on schedule.
- .3 should the progress schedule indicate in the opinion of the Construction Program Manager that the Contractor is fourteen (14) or more days behind schedule at any time during construction up until thirty (30) days prior to scheduled Substantial Completion.
- .4 should the progress schedule indicate in the opinion of the Construction Program Manager that the Contractor is seven (7) or more days behind schedule at any time during the last thirty (30) days prior to scheduled Substantial Completion.

4.11 PROGRESS SCHEDULE

- 4.11.1 The Contractor shall prepare and submit to the Construction Program Manager for the Owner's review and approval an as-planned progress schedule for the Work pursuant to Division 1, Section 01311 of the General Requirements entitled "Schedules and Reports". This Schedule shall be submitted after notice of apparent low bidder status, but prior to contract award.

4.12 RESPONSIBILITY FOR COMPLETION

- 4.12.1 The Contractor shall furnish such manpower, materials, facilities and equipment and shall work such hours, including night shifts, overtime operations and Sundays and holidays, as may be necessary to ensure the performance of the Work within the Milestone and Completion dates specified in the Owner-Contractor Agreement. If it becomes apparent to the Construction Program Manager, Design Consultant or Owner that the Work will not be completed within required Milestone or Completion dates, the Contractor agrees to undertake some or all of the following actions, at no additional cost to the Owner, in order to ensure, in the opinion of the Construction Program Manager, Design Consultant or Owner, that the Contractor will comply with all Milestone and Completion date requirements:
 - .1 increase manpower, materials, crafts, equipment and facilities to accelerate performance of the Work;
 - .2 increase the number of working hours per shift, shifts per working day, working days per week, or any combination of the foregoing; and
 - .3 reschedule activities to achieve maximum practical concurrence of accomplishment of activities.
- 4.12.2 In undertaking the actions required under paragraph 4.12.1, Contractor shall comply with the requirements for a Recovery Schedule set forth in Division 1, Section 01311 of the General Requirements entitled "Schedules and Reports".

- 4.12.3 If the actions taken by the Contractor are not satisfactory, the Construction Program Manager, Design Consultant or Owner may direct the Contractor to take any and all actions necessary to ensure completion within the required Milestone and Completion dates (which shall be at Contractor's sole expense), without additional cost to the Owner. In such event, the Contractor shall continue to assume responsibility for his performance and for completion within the required dates.
- 4.12.4 If, in the opinion of the Construction Program Manager, Design Consultant or Owner, the actions taken by the Contractor pursuant to this Article or the progress or sequence of Work are not accurately reflected on the Construction Schedule, the Contractor shall revise such schedule to accurately reflect the actual progress and sequence of Work.
- 4.12.5 Failure of the Contractor to substantially comply with the requirements of this Article and Division 1, Section 01311 of the General Requirements entitled "Schedules and Reports", may be considered grounds for a determination by the Owner, pursuant to Article 14, that the Contractor is failing to prosecute the Work with such diligence as will ensure its completion within the time specified.
- 4.12.6 The Owner may, at its sole discretion and for any reason, other than when it becomes apparent to the Construction Program Manager, Design Consultant or Owner that the Work will not be completed within the required Milestone or Completion dates, require the Contractor to accelerate the Schedule of Performance by providing overtime, Saturday, Sunday and/or holiday work and/or by having all or any Subcontractors designated by the Owner provide overtime, Saturday, Sunday, and/or holiday work. In the event that the Owner requires such acceleration a Change Order shall be issued in accordance with Article 12.
- 4.12.7 This paragraph 4.12 does not eliminate the Contractor's responsibility to comply with the local noise ordinances, all highway permit requirements and all other applicable laws, regulations, rules, ordinances, resolutions, and permit requirements.

4.13 DOCUMENTS AND SAMPLES AT THE SITE

- 4.13.1 The Contractor shall maintain at the site for the Owner one record copy of all Drawings, Specifications, Addenda, Change Orders and other Modifications, in good order and marked currently to record all changes made during construction, and approved Shop Drawings, Product Data and Samples. These shall be delivered to the Construction Program Manager for the Owner upon completion of the Work.

4.14 SHOP DRAWINGS, PRODUCT DATA AND SAMPLES

- 4.14.1 Shop Drawings are drawings, diagrams, schedules and other data specially prepared for the Work by the Contractor or any Subcontractor, manufacturer, supplier or distributor to illustrate some portion of the Work.

- 4.14.2 Product Data are illustrations, standard schedules, performance charts, instructions, brochures, diagrams and other information furnished by the Contractor to illustrate a material, product or system for some portion of the Work.
- 4.14.3 Samples are physical examples which illustrate materials, equipment or workmanship and establish standards by which the Work will be judged.
- 4.14.4 Manuals are manufacturer's installation, start-up, operating, maintenance and repair instructions together with parts lists, pictures, sketches and diagrams which set forth the manufacturer's requirements for the benefit of the Contractor and the Owner.
- 4.14.5 The Contractor shall review, approve and submit, with reasonable promptness and in such sequence as to cause no delay in the Work or in the work of the Owner or any separate contractor, all Shop Drawings, Product Data, Manuals and Samples required by the Contract Documents.
 - 4.14.5.1 Unless otherwise directed in writing, the Contractor shall submit no less than eight (8) copies of each Shop Drawing, Product Data, or Manuals to the Design Consultant. Routing of said submittals will be from the Contractor to the Construction Program Manager to the Design Consultant to the Owner. The Owner will return four (4) copies of each submittal directly to the Construction Program Manager who will direct them to the Contractor.
 - 4.14.5.2 Where the Contract calls for the submittal of manufacturer's data to the Design Consultant for information only, such submittals shall be made before the commencement of any portion of the Work requiring such submission.
 - 4.14.5.3 For standard manufactured items not requiring special shop drawings for manufacture, submit seven (7) copies of manufacturer's catalog sheets showing illustrated cuts of item to be furnished, scale details, sizes, dimensions, performance characteristics, capacities, wiring diagrams and controls, and all other pertinent information. Four (4) copies of reviewed submissions will be returned to the Contractor.
 - 4.14.5.4 For all other shop drawings, submit legible, unfolded, reproducible (positive side up sepia) transparencies and seven (7) opaque prints(s) for each drawing. Each drawing shall have a clear space for stamps. When phrase "by others" appears on shop drawings, the Contractor shall indicate on the drawing who is to furnish material or operations so marked before submittal. When shop drawings are checked "revise and resubmit", the Contractor shall correct original tracing and submit a new transparency and opaque print for review. The transparency shall contain the contractors "approval" and corrections.
 - 4.14.5.5 For use of all trades, the Contractor shall provide such number of prints as are required for field distribution.

- 4.14.5.6 The Design Consultant will add on this reproducible his corrections and mark "No Exceptions" or "Revise and Resubmit" and return same to Contractor.
- 4.14.5.7 Shop Drawings marked "No Exceptions": All copies for use or distribution shall be made from this APPROVED REPRODUCIBLE, and submitted as outlined in Item 4.14.5.1 and 4.14.5.2.
- 4.14.5.8 Shop Drawings marked "Revise & Resubmit": Upon receipt of reproducible the Contractor shall have original corrected and resubmit as outlined in Item 4.14.5.
- 4.14.5.9 Submit names of proposed manufacturers, materialmen, dealers, who are to furnish materials, fixtures, appliances or other fittings for approval as early as possible, to afford proper investigation, checking.
- 4.14.5.10 Transactions with manufacturers, or Subcontractors, shall be through Contractor.
- 4.14.5.11 Unless otherwise specified, submit samples in duplicate of adequate size showing quality, type, color range, finish, texture.
- 4.14.5.12 Where specifications require manufacturer's printed installation instructions, submit duplicate copies of such instructions for approval.
- 4.14.5.13 Where several materials are specified by name for one use, select for use any of those so specified.
- 4.14.5.14 Whenever item or class of material is specified exclusively by trade name, manufacturer's name, or by catalog reference, use only such item, unless written approval for substitution is secured, as outlined in A-17, Instructions to Bidders, or Article 4.15, General Conditions.
- 4.14.5.15 Do not order materials until receipt of written approval. Furnish materials equal in every respect to approved samples.
- 4.14.6 By approving and submitting Shop Drawings, Product Data, Manuals and Samples, the Contractor represents that he has determined and verified all materials, field measurements, and field construction criteria and that he has checked and coordinated the information contained within such submittals with the requirements of the Work and of the Contract Documents. The Contractor shall adhere to any supplementary processing and scheduling instructions pertaining to Shop Drawings which may be issued by the Construction Program Manager.
- 4.14.6.1 Parts and details not fully indicated on the contract drawings shall be detailed by the Contractor in accordance with standard engineering practice. Dimensions on the Contract Drawings, as well as detailed drawings themselves are subject in every case to measurements of existing, adjacent, incorporated and completed work, which shall be taken by the Contractor before undertaking any work dependent on such data.

- 4.14.7 The Contractor shall not be relieved of responsibility for any deviation from the requirements of the Contract Documents by the Design Consultant's review of Shop Drawings, Product Data, Samples or Manuals under Subparagraph 2.2.14 unless the Contractor has specifically informed the Design Consultant in writing of such deviation at the time of submission and the Design Consultant has given written approval to the specific deviation by a written field order. The Contractor shall not be relieved from responsibility for errors or omissions in the Shop Drawings, Product Data, Samples, or Manuals by the Design Consultant's review thereof.
- 4.14.8 The Contractor shall make corrections required by the Design Consultant and shall resubmit the required number of corrected copies of Shop Drawings or new Product Data or Samples. The Contractor shall direct specific attention, in writing or on resubmitted Shop Drawings, Product Data or Samples, to revisions other than those requested by the Design Consultant on previous submittals. Resubmittals necessitated by required corrections due to Contractor's errors or omissions shall not be cause for extension of Contract Time.
- 4.14.9 The Contractor shall direct specific attention, in writing or on resubmitted Shop Drawings, Product Data, Samples or Manuals, to revisions other than those requested by the Design Consultant on previous submittals.
- 4.14.9.1 No portion of the Work requiring submission of Shop Drawings, Product Data, Samples or Manuals shall be commenced until the submittal has been approved by the Design Consultant as provided in Article 2. All such portions of the Work shall be in accordance with approved submittals.
- 4.14.10 Shop Drawings, Product Data and Samples shall be dated and shall bear the name of the Project; a description or the names or equipment, materials and items; and complete identification of locations at which materials or equipment are to be installed.
- 4.14.11 Submittals of Shop Drawings, Product Data, Samples or Manuals shall be accompanied by a transmittal letter, in duplicate, containing the name of the Project, the Contractor's name, the number of Shop Drawings, Product Data, Samples, or Manuals and titles and other pertinent data.

4.15 EQUAL PRODUCTS AND SUBSTITUTIONS

- 4.15.1 All materials, supplies and articles furnished under this Contract shall, whenever specified and otherwise practicable, be the standard products of recognized, reputable manufacturers. Unless otherwise specifically provided in the Contract Documents, the naming of a certain brand, make, manufacturer or article, device, product, material, fixture or type of construction shall convey the general style, type, character and standard of quality of the article desired and shall not be construed as limiting competition. The Contractor, in such cases, may with Owner approval, use any brand, make, manufacturer, article, device, product, material, fixture, form or type of

construction which in the judgement of the Owner, the Construction Program Manager and Design Consultant is equal to that specified. An item may be considered equal to the item so named or described if, in the opinion of the Owner, Construction Program Manager and Design Consultant (1) it is at least equal in quality, durability, appearance, strength, and design; (2) it will perform at least equally the specific function imposed by the general design for the work being contracted for or the material being purchased; and (3) it conforms substantially, even with deviations, to the detailed requirements for the item in the specifications. Approval by the Owner, the Construction Program Manager and Design Consultant will be granted based upon considerations of quality, workmanship, economy of operation, suitability for the purpose intended, and acceptability for use on the Project.

4.15.2 To obtain such approval on makes or brands of material other than those specified in Contract Documents, and not previously approved during the bidding, the Contractor's request for approval of any substitution shall include:

- .1 complete data substantiating compliance of the proposed substitution with the Contract Documents;
- .2 product identification including manufacturer's name, address, and phone number;
- .3 manufacturer's literature showing complete product description, performance and test data, and all reference standards;
- .4 samples and colors in the case of articles or products;
- .5 name and address of similar projects on which the product was used and date of installation;
- .6 for construction methods, include a detailed description for the proposed method and drawings illustrating same;
- .7 itemized comparison of proposed substitution with product or method specified and any cost reduction which shall benefit the Owner;
- .8 accurate cost data on proposed substitution in comparison with product or method specified; and
- .9 all directions, specifications, and recommendations by manufacturers for installation, handling, storing, adjustment, and operation.

4.15.3 The Contractor shall also submit with his request for approval a sworn and notarized statement which shall include all of the following representations by the Contractor, namely that:

- .1 he has investigated the proposed product or method and determined that it is equal or better in all respects to that specified and that it fully complies with all requirements of the Contract Documents;
- .2 he will meet all contract obligations with regard to this substitution;
- .3 he will coordinate installation of accepted substitutions into the work, making all such changes and any required schedule adjustments, at no additional cost to the Owner, as may be required for the Work to be complete in all respects;
- .4 he waives all claims for additional costs and additional time related to substitutions which consequently become apparent. He also agrees to hold the Owner harmless from claims for extra costs and time incurred by other Subcontractors and suppliers, or additional services which may have to be performed by the Construction Program Manager and/or Design Consultant, for changes for extra work that may, at some later date, be determined to be necessary in order for the Work to function in the manner intended in the Contract Documents;
- .5 he will provide the same warranty and guarantee, and perform any work required in accordance therewith, for the substitution that is applicable to the specified item for which the substitution is requested;
- .6 material will be installed, handled, stored, adjusted, tested, and operated in accordance with the manufacturers' recommendation and as specified in the Contract Documents.
- .7 in all cases new materials will be used unless this provision is waived by notice from the Owner or his Design Consultant, or unless otherwise specified in the Contract Documents;
- .8 all material and workmanship will be in every respect in accordance with that which, in the opinion of the Owner, Construction Program Manager, or Design Consultant, is in conformity with approved modern practice;
- .9 he has provided accurate cost data on the proposed substitution in comparison with the product or method specified.

4.15.4 Subject to the provisions of any applicable laws, approval for substitutions or equal products shall be at the sole discretion of the Owner, shall be in writing to be effective, and the decision of the Owner shall be final. The Owner or Design Consultant, through the Construction Program Manager, may require tests of all materials proposed for substitution so submitted to establish quality standards, at the Contractor's expense. After approval of a substitution, if it is determined that the Contractor submitted defective information or data regarding the substitution upon which Owner's approval was based, and that unexpected or unanticipated extensive

redesign or rework of the project will be required in order to accommodate the substitution, or that the substituted item will not perform or function as well as the specified item for which substitution was requested, the Contractor will be required to furnish the original specified item or request approval to use another substitution; the Contractor shall pay all costs, expenses or damages associated with or related to the unacceptability of such a substitution and the resultant utilization of another item and no time extension shall be granted for any delays associated with or related to such substitution.

4.15.5 If a substitution is approved, no change in brand or make will be permitted unless satisfactory, written evidence is presented to and approved by the Owner that the manufacturer cannot make scheduled delivery of the approved substituted item. Substitutions will not be considered for approval by the Owner if:

- .1 the proposed substitution is indicated or implied on the Contractor's shop drawing or product data submittal and has not been formally submitted for approval by the Contractor in accordance with the above-stated requirements, or
- .2 acceptance of the proposed substitution will require substantial design revisions to the Contract Documents or is otherwise not acceptable to the Owner, Construction Program Manager and Design Consultant.

4.15.6 Except as otherwise provided for by the provisions of any applicable laws, the Contractor shall not have any right of appeal from the decision of the Owner condemning any materials submitted if the Contractor fails to obtain the approval for substitution under this Article.

4.16 USE OF SITE

4.16.1 The Contractor shall confine operations at the site to areas provided by the Owner permitted by law, ordinances, permits, easements, right-of-way agreements and the Contract Documents. The Contractor shall not unreasonably encumber the site, in the opinion of the Owner or the Construction Program Manager, with any materials, equipment or trailers nor shall he block the entrances or otherwise prevent reasonable access to the site, other working and parking areas, completed portions of the Work and/or properties, storage areas, areas of other facilities that are adjacent to the worksite. If the Contractor fails or refuses to move said material, equipment or trailers within 24 hours of notification by the Owner, through the Construction Program Manager, to so do, the Owner shall have the right, without further notice, to remove, at the Contractor's expense, any material, equipment and/or trailers which the Owner deems are in violation of this paragraph.

4.17 CUTTING AND PATCHING OF WORK

4.17.1 The Contractor shall be responsible for all cutting, fitting or patching that may be required to complete the Work or to make its several parts fit together properly and in accordance with the Contract Documents.

4.17.2 The Contractor shall not damage or endanger any portion of the Work or the work of the Owner or any separate contractors by cutting, patching or otherwise altering any work, or by excavation. The Contractor shall not cut or otherwise alter the work of the Owner or any separate contractor except with the written consent of the Owner and of such separate contractor. The Contractor shall not unreasonably withhold from the Owner or any separate contractor his consent to cutting or otherwise altering the Work. The Owner shall not be required to accept Work with a cut, splice, or patch when such cut, splice or patch is not generally accepted practice for the particular work involved or is otherwise unworkmanlike in the opinion of the Construction Program Manager, the Design Consultant, or the Owner.

4.17.3 Existing structures and facilities including but not limited to building, utilities, topography, streets, curbs, walks, etc., that are damaged or removed due to required excavations or other construction work, shall be patched, repaired or replaced by the Contractor to satisfaction of the Construction Program Manager, the Architect and the Owner of such structures and facilities and authorities having jurisdiction. In event the local jurisdictional authorities require that such repairing and patching be done with their own labor and materials, the Contractor shall abide by such regulations and pay for such work.

4.18 CLEANING UP

4.18.1 The Contractor at all times shall keep the premises free from accumulation of waste materials or rubbish caused by his operations. At the completion of the Work and before Final Payment is made, he shall remove all his waste materials and rubbish from and about the Project as well as all his tools, construction equipment, machinery and surplus materials.

4.18.2 If the Contractor fails to clean up during or at the completion of the Work, the Owner may do so as provided in Paragraph 6.3 and the cost thereof shall be charged to the Contractor.

4.19 COMMUNICATIONS

4.19.1 The Contractor shall generally forward its communications and communications from his subcontractors, or to the Owner, through the Construction Program Manager.

4.20 ROYALTIES AND PATENTS

4.20.1 The Contractor shall pay all royalties and license fees. He shall defend all suits or claims for infringement of any patent rights and shall save the Owner harmless from loss, damages, costs or attorneys' fees on account thereof.

4.21 INDEMNIFICATION

- 4.21.1 To the fullest extent permitted by law, the Contractor shall, at his sole cost and expense, indemnify, defend, and hold harmless the Owner, the Construction Program Manager and the Design Consultant and their agents, representatives, and employees from and against all claims, actions, judgments, costs, liabilities, penalties, damages, losses and expenses, including but not limited to attorneys' fees, arising out of or resulting from the performance of the Work, provided that any such claim, action, judgment, cost, liability, penalty, damage, loss or expense (1) is attributable to bodily injury, sickness, disease or death, or to injury to or destruction of tangible property (other than the Work itself) including the loss of use resulting therefrom, and (2) is caused in whole or in part by any negligent act or omission of the Contractor, any Subcontractor, anyone directly or indirectly employed by any of them or anyone for whose acts any of them may be liable, regardless of whether or not it is caused in part by a party indemnified hereunder. Such obligation shall not be construed to negate, abridge, or otherwise reduce any other right or obligation of indemnity which would otherwise exist as to any party or person described in this Paragraph 4.21. Contractor specifically agrees that it has included Fifty Dollars (\$50.00) in its bid price, over and above what it otherwise would have bid, to compensate Contractor for all indemnity obligations contained in the Contract Documents.
- 4.21.2 In any and all claims against the Owner, the Construction Program Manager or the Design Consultant or any of their agents, representatives, or employees by any employee of the Contractor, any Subcontractor, anyone directly or indirectly employed by any of them or anyone for whose acts any of them may be liable, the indemnification obligation under this Paragraph 4.21 shall not be limited in any way by any limitation on the amount or type of damages, compensation or benefits payable by or for the Contractor or any Subcontractor under workers' or workmen's compensation acts, disability benefit acts or other employee benefit acts.
- 4.21.3 No provision of this Paragraph 4.21 shall give rise to any duties on the part of the Construction Program Manager, the Design Consultant, the Owner, or any of their agents, representatives, or employees.

4.22 PERSONS AUTHORIZED TO SIGN DOCUMENTS

- 4.22.1 The Contractor, within five (5) days after the earlier of the date of a notice to proceed or the date of the Owner-Contractor Agreement, shall file with the Construction Program Manager a list of all persons who are authorized to sign documents such as contracts, certificates, and affidavits on behalf of the Contractor and to fully bind the Contractor to all the conditions and provisions of such documents, except that in the case of a corporation he shall file with the Construction Program Manager a certified copy of a resolution of the Board of Directors of the corporation in which are listed the names and titles of corporation personnel who are authorized to sign documents on

behalf of the corporation and to fully bind the corporation to all the conditions and provisions of such documents.

4.23 CONDITIONS AFFECTING THE WORK

4.23.1 The Contractor shall be responsible for taking all steps necessary to ascertain the nature and location of the Work and the general and local conditions which can affect the Work or the cost thereof. Failure by the Contractor to fully acquaint himself with conditions which may affect the Work, including, but not limited to conditions relating to transportation, handling, storage of materials, availability of labor, water, roads, weather, topographic and subsurface conditions, multi-prime contract conditions, applicable provisions of law, and the character and availability of equipment and facilities needed prior to and during the execution of the Work, shall not relieve the Contractor of his responsibilities under the Contract Documents and shall not constitute a basis for an adjustment in the Contract Sum or the Contract Time under any circumstances. The Owner assumes no responsibility for any understanding or representation about conditions affecting the Work made by any of his officers, employees, representatives, or agents prior to the execution of the Contract, unless such understandings or representations are expressly stated in the Contract Documents.

4.23.2 If in the execution of the Work any valuable items or materials of any kind are discovered within the work, such items or materials shall be the property of the Owner. The Contractor shall take reasonable precautions to prevent any persons from removing or damaging such items or materials and shall immediately upon discovery thereof and before removal, acquaint the Construction Program Manager or the Design Consultant with such discovery and carry out the Construction Program Manager or the Design Consultant's orders as to disposal of the same.

END OF ARTICLE 4

ARTICLE 5

SUBCONTRACTORS

5.1 DEFINITION

5.1.1 A Subcontractor is a person or entity who has a direct contract with the Contractor to perform any of the Work at the site. The term Subcontractor is referred to throughout the Contract Documents as if singular in number and masculine in gender and means a Subcontractor or his authorized representative. The term Subcontractor does not include any separate contractor or his subcontractors.

5.1.2 A Sub-subcontractor is a person or entity who has a direct or indirect contract with a Subcontractor to perform any of the Work at the site. The term Sub-subcontractor is

referred to throughout the Contract Documents as if singular in number and masculine in gender and means a Sub-subcontractor or an authorized representative thereof.

5.1.3 Nothing contained in the Contract Documents is intended to, nor shall it create, any contractual relationship between the Owner, the Construction Program Manager, the Design Consultant, or any of their agents, consultants, employees, independent contractors, or representatives and any Subcontractor, Sub-subcontractor, supplier or vendor of the Contractor, but the Owner shall be entitled to performance of all obligations intended for his benefit, and to enforcement thereof.

5.1.4 The Construction Program Manager and Design Consultant will not deal directly with any Subcontractor or Sub-subcontractor or materials supplier. Communication will be made only through the Contractor. Subcontractor, Sub-subcontractors or material suppliers shall route requests for information or clarification through the Contractor to the Construction Program Manager, who will direct them to the Design Consultant.

5.2 AWARD OF SUBCONTRACTS AND OTHER CONTRACTS FOR PORTIONS OF THE WORK

5.2.1 The Contractor, in compliance with the requirements of the Contract Documents, shall furnish to the Owner and the Construction Program Manager in writing the names of the persons or entities (including those who are to furnish materials or equipment fabricated to a special design) proposed for each of the principal portions of the Work. The Construction Program Manager will promptly reply to the Contractor in writing stating whether or not the Owner after due investigation, has reasonable objection to any such proposed person or entity. Failure of the Construction Program Manager to reply within a reasonable time shall constitute notice of no reasonable objection. The Contractor understands and agrees that no contractual agreement exists for any part of the Work under this Contract between the Owner, Construction Program Manager or Design Consultant and any of the Contractor's Subcontractors or Sub-subcontractors. Further, the Contractor understands and agrees that he alone is responsible to the Owner for all of the Work under this Contract and that any review of Subcontractors or Sub-subcontractors by the Owner or Construction Program Manager will not in any way make the Owner or Construction Program Manager responsible to any Subcontractor, nor responsible for the actions or failures of any Subcontractor or Sub-subcontractor.

5.2.1.1 The Contractor, prior to Contract award and in accordance with the Instructions to Bidders, shall furnish to the Construction Program Manager in writing for acceptance by the Owner, a list of names of the Subcontractors proposed for the principal portions of the Work.

5.2.2 The Contractor shall not contract with any such proposed person or entity to whom the Owner has made reasonable objection under the provisions of Subparagraph 5.2.1. The Contractor shall not be required to contract with anyone to whom he has a reasonable objection.

- 5.2.3 If the Owner or the Construction Program Manager has reasonable objection to any proposed person or entity under Subparagraph 5.2.1, the Contractor shall name a substitute to whom the Owner or the Construction Program Manager has no reasonable objection. The Contract Sum shall be increased or decreased by the difference in cost occasioned by such substitution and an appropriate Change Order shall be issued, subject to an audit of said difference by the Owner; provided, however, that no increase in the Contract Sum shall be allowed for any such substitution unless the Contractor has acted promptly and responsively in submitting names as required by Subparagraph 5.2.1; or if the Owner or Construction Program Manager has stated said objection in writing before the submission by the Subcontractors of a proposal acceptable to Contractor; or if said Subcontractor is unable to enter into and carry out his work under his proposed Subcontract; or if said Subcontractor fails to comply with all applicable laws; or if the proposed Subcontractor is not an on-going business in the field of his proposed Subcontract; or if the proposed Subcontractor does not have a labor force and the means of supply compatible with the scope of the subcontract.
- 5.2.4 If the Owner requires a change of any proposed Subcontractor or person or organization previously accepted by him, the Contract Sum shall be increased or decreased by the difference in cost occasioned by such change and an appropriate Change Order shall be issued, subject to an audit by Owner.
- 5.2.5 The Contractor shall make no substitution for any Subcontractor, person or entity previously selected if the Owner, the Construction Program Manager, or the Design Consultant makes reasonable objection to the such substitution.

5.3 SUBCONTRACTUAL RELATIONS

- 5.3.1 By an appropriate agreement, written where legally required for validity, the Contractor shall require each Subcontractor, to the extent of the Work to be performed by the Subcontractor, to be bound to the Contractor by the terms of the Contract Documents, and to assume toward the Contractor all the obligations and responsibilities which the Contractor, by these Documents, assumes toward the Owner. Said agreement shall preserve and protect the rights of the Owner under the Contract Documents with respect to the Work to be performed by the Subcontractor so that the subcontracting thereof will not prejudice such rights, and shall allow to the Subcontractor, unless specifically provided otherwise in the Contractor- Subcontractor agreement, the benefit of all rights, remedies and redress against the Contractor that the Contractor, by these Documents, has against the Owner. Where appropriate, the Contractor shall require each Subcontractor to enter into similar agreements with his sub-subcontractors. The Contractor shall make available to each proposed Subcontractor, prior to the execution of the Subcontract, copies of the Contract Documents to which the Subcontractor will be bound by this Paragraph 5.3, and identify to the Subcontractor any terms and conditions of the proposed Subcontract which may be at variance with the Contract Documents. Each Subcontractor shall similarly make copies of such Documents available to his Sub-subcontractors.

5.3.2 The provisions herein regarding Subcontractor approvals shall in no way affect the liability of the Contractor to the Construction Program Manager or Owner regarding performance of all obligations by or payment of Subcontractors. Approval to subcontract and of any given Subcontractor shall not to any degree relieve the Contractor of his obligation to perform or have performed to the full satisfaction of the Owner all of the work required by this Contract.

5.4 QUALIFICATION SUBMITTALS

5.4.1 Specific qualification submittals may be required of Subcontractors, installers and suppliers for certain critical items of the Work. Required qualification submittals are set forth in detail in the Technical Specifications and shall be collected and submitted by the Contractor for review and approval by the Design Consultant. All information required of a single Subcontractor, installer or supplier shall be contained in a single, complete submittal. The Contractor shall submit the required qualification information within ten (10) days after receipt of the Design Consultant's request.

5.4.2 The Construction Program Manager, the Design Consultant, and the Owner shall reject any proposed Subcontractor, installer or supplier, or any qualification submittals related thereto, for the following reasons:

- .1 the Contractor's failure to submit requested information within the specified time;
or
- .2 the Contractor's failure to provide all of the requested information; or
- .3 the Contractor's submission of a Subcontractor, installer or supplier, or qualifications thereof, which are unacceptable in the judgment of the Owner, the Construction Program Manager, or Design Consultant.

5.4.3 Should the Construction Program Manager, the Design Consultant, and the Owner have reasonable objection to any proposed Subcontractor, installer or supplier, the Contractor shall submit another firm for approval by the Design Consultant, the Construction Program Manager, and Owner.

5.5 PREPARATORY WORK

5.5.1 Before starting any Section of Work, the responsible Subcontractor shall carefully examine all preparatory work that has been executed to receive his work. He shall check carefully, by whatever means are required, to ensure that his work and adjacent related work will finish to proper contours, planes and levels. He shall promptly notify the Contractor and the Construction Program Manager of any defects or imperfections in preparatory work which will, in any way, affect satisfactory completion of his Work. Absence of such notification will be construed as an acceptance of preparatory work and later claims of defects therein will not be recognized.

- 5.5.2 Under no condition shall a Section of Work proceed prior to preparatory work having been completed, cured, dried, and otherwise made satisfactory to receive such related work. Responsibility for timely installation of all materials rests solely with the Contractor, who shall maintain coordination control at all times.

END OF ARTICLE 5

ARTICLE 6

WORK BY OWNER OR BY SEPARATE CONTRACTORS

6.1 OWNER'S RIGHT TO PERFORM WORK AND TO AWARD SEPARATE CONTRACTS

- 6.1.1 The Owner reserves the right to perform work related to the Project with his own forces, and to award separate contracts in connection with other portions of the Project or other work on the site under these or similar Conditions of the Contract.

- 6.1.2 When separate contracts are awarded for different portions of the Project or other work on the site, the term Contractor in the Contract Documents in each case shall mean the Contractor who executes each separate Owner-Contractor Agreement.

6.2 MUTUAL RESPONSIBILITY

- 6.2.1 The Contractor shall afford other contractors, the Construction Program Manager and the Owner reasonable opportunity for the introduction and storage of their materials and equipment and the execution of their work and shall properly connect and coordinate the Work with that of the Owners, the Construction Program Manager and other contractors to store his apparatus, materials, supplies and equipment in such orderly fashion at the site of the Work as will not unduly or unreasonably interfere with the progress of the Work or the work of any other contractors.

- 6.2.1.1 If the execution or result of any part of the Work depends upon any work of the Owner or of any separate contractor, the Contractor shall, prior to proceeding with the Work, inspect and promptly report to the Owner in writing any apparent discrepancies or defects in such work of the Owner or of any separate contractor that render it unsuitable for such proper execution or result of any part of the Work.

- 6.2.1.2 Failure of the Contractor to so inspect and report shall constitute an acceptance of the Owner's or separate contractor's work as fit and proper to receive the Work, except as to defects which may develop in the Owner's or separate contractor's work after

completion of the Work and which the Contractor could not have discovered by its inspection prior to completion of the Work.

- 6.2.2 Should the Contractor cause damage to the work or property of the Owner or of any separate contractor on the Project, or to other work on the Site, or delay or interfere with the Owner's work on ongoing operations or facilities or adjacent facilities or said separate contractor's work, the Contractor shall be liable for the same; and, in the case of another contractor, the Contractor shall attempt to settle said claim with such other contractor prior to such other contractor's institution of litigation or other proceedings against the Contractor.
- 6.2.2.1 If such separate contractor sues the Owner or the Construction Program Manager or Design Consultant on account of any damage, delay or interference caused or alleged to have been caused by the Contractor, the Owner shall notify the Contractor, who shall defend the Owner, the Construction Program Manager and Design Consultant in such proceedings at the Contractor's expense. If any judgment or award is entered against the Owner, Construction Program Manager or Design Consultant, the Contractor shall satisfy the same and shall reimburse the Owner, Construction Program Manager and Design Consultant for all damages, expenses, attorneys' fees and other costs which the Owner, Construction Program Manager or Design Consultant incurs as a result thereof.
- 6.2.3 Should a separate contractor cause damage to the Work or to the property of the Contractor or cause delay or interference with the Contractor's performance of the Work, the Contractor shall present directly to said separate contractor any claims it may have as a result of such damage, delay or interference (with an information copy to the Owner) and shall attempt to settle its claim against said separate contractor prior to the institution of litigation or other proceedings against said separate contractor.
- 6.2.3.1 In no event shall the Contractor seek to recover from the Owner, the Construction Program Manager, or the Design Consultant, and the Contractor hereby warrants to the Owner, Construction Program Manager and Design Consultant that it will not seek to recover from them, or any of them, any costs, expenses (including, but not limited to, attorney's fees) or damages or other losses incurred by the Contractor as a result of any damage to the Work or property of the Contractor or any delay or interference caused by any separate contractor.
- 6.2.3.2 In order to carry out the intent of this Article 6, Contractor agrees that privity of contract exists between Contractor and any separate contractor, as defined herein, for the purpose of disposing of the liabilities or obligations which are imposed upon said parties to each other hereunder; and Contractor agrees to accept service of process and to sue and be sued in Contractor's own name in any litigation which may arise hereunder between Contractor and any separate contractor.
- 6.2.4 Whenever Contractor receives items from another Contractor or from Owner for storage, erection or installation, the Contractor receiving such items shall give receipt

for items delivered, and thereafter will be held responsible for care, storage and any necessary replacing of item or items received.

6.2.5 When certain items of equipment and other work are indicated as "NIC" (not in contract), or to be furnished and installed under other contracts, any requirements for preparation of openings, provision of backing, etc., for receipt of such "NIC" work will be furnished upon written request of the Contractor who shall properly form and otherwise prepare his work in a satisfactory manner to receive such "NIC" work.

6.3 OWNER'S RIGHT TO PERFORM DISPUTED WORK

6.3.1 If a dispute arises between the Contractor and separate contractors as to their responsibility for cleaning up as required by Paragraph 4.18 or for accomplishing coordination or doing required cutting, filling, excavating or patching as required by Paragraph 4.17, the Owner may carry out such Work and charge the cost thereof to the contractors responsible therefor as the Owner or the Construction Program Manager shall determine to be just. Such determination shall be final.

6.4 COORDINATION OF THE WORK

6.4.1 By entering into this contract, Contractor acknowledges that there may be other contractors on the site whose work will be coordinated with that of his own. Contractor expressly warrants and guarantees that he will cooperate with other contractors and will do nothing to delay, hinder or interfere with the work of other separate contractors, the Owner, the Construction Program Manager or Design Consultant. Contractor also expressly agrees that, in the event his work is hindered, delayed, interfered with or otherwise affected by a separate contractor, his sole remedy will be a direct action against the separate contractor as described in this Article 6. Contractor will have no remedy, and hereby expressly waives and releases any remedy, against the Owner and/or the Construction Program Manager or Design Consultant on account of delay, hindrance, interference or other event caused by a separate contractor.

END OF ARTICLE 6

ARTICLE 7

MISCELLANEOUS PROVISIONS

7.1 GOVERNING LAW

7.1.1 Unless otherwise provided in the Contract Documents, the Contract shall be governed by the law of the State of Florida. The sole and exclusive venue for any litigation arising from or related to this Contract, shall be in **St. Johns County**, Florida.

7.1.2 Each and every provision of law and clause required by law to be inserted in this Contract shall be deemed to be inserted herein and the Contract shall be read and enforced as though it were included herein. If through mistake or otherwise, any such provision is not inserted or is not correctly or fully inserted, then upon the application of either party, the Contract shall forthwith be physically amended to make such insertion.

7.2 SUCCESSORS AND ASSIGNS

7.2.1 The Owner and the Contractor each binds himself, his partners, successors, assigns and legal representatives to the other party hereto and to the partners, successors, assigns and legal representatives of such other party in respect to all covenants, agreements and obligations contained in the Contract Documents. The Contractor shall not assign the Contract or sublet it as a whole without the written consent of the Owner, nor shall the Contractor assign any moneys due or to become due to him hereunder, without the previous written consent of the Owner and the Contractor's Surety.

7.3 CLAIMS AND DAMAGES

7.3.1 Should the Contractor suffer injury or damage to person or property because of any act or omission of the Owner, Construction Program Manager or Design Consultant, or of any of their employees, agents or others for whose acts either is legally liable, notice of same shall be given in writing to the Owner within 25 days after the first observance of such injury or damage; otherwise, the Contractor shall have waived and released any and all rights he may have against the Owner, the Construction Program Manager, the Design Consultant, or their employees, representatives and agents which are not otherwise covered by Contractor's indemnity obligations set forth in the Contract Documents.

7.4 PERFORMANCE BOND AND LABOR AND MATERIAL PAYMENT BOND

7.4.1 The Contractor shall furnish bonds covering the faithful performance of the Contract and the payment of all obligations and damages arising thereunder whether same be direct or indirect, real or consequential in a form and with a surety satisfactory to the Owner. It is expressly agreed that the Surety shall be responsible for any delay or liquidated damages assessed against Contractor.

7.4.2 The Contractor is required to furnish in duplicate a Performance Bond and a Labor and Material Payment Bond, each in the amount of one-hundred percent (100%) of the Contract sum.

7.5 RIGHTS AND REMEDIES

7.5.1 The duties and obligations of the Contractor imposed by the Contract Documents and the rights and remedies of the Owner available thereunder shall be in addition to and not a limitation of any duties, obligations, rights and remedies otherwise imposed or available by law.

7.5.2 Except as may be specifically agreed in writing, the failure of the Owner, the Construction Program Manager, or the Design Consultant to insist in any one or more instances upon the strict performance of any one or more of the provisions of this Contract, or to exercise any right herein contained or provided by law, shall not be construed as a waiver or relinquishment of the performance of such provisions or right(s) or of the right to subsequently demand such strict performance or exercise such right(s), and the rights shall continue unchanged and remain in full force and effect.

7.5.3 The Contractor agrees that he can be adequately compensated by money damages for any breach of this Contract which may be committed by the Owner and hereby agrees that no default, act, or omission of the Owner, the Construction Program Manager or the Design Consultant, except for failure to make progress payments as required by the Contract Documents, shall constitute a material breach of the Contract entitling the Contractor to cancel or rescind the provisions of this Contract or (unless the Owner shall so consent or direct in writing) to suspend or abandon performance of all or any part of the Work. The Contractor hereby waives and releases any and all rights and remedies to which he might otherwise be or become entitled, save only his right to money damages.

7.6 TESTS

7.6.1 If the Contract Documents, laws, ordinances, rules, regulations or orders of any public authority having jurisdiction require any portion of the Work to be inspected, tested, or approved, the Contractor shall give the Construction Program Manager timely notice of its readiness so the Design Consultant and the Construction Program Manager may observe such inspection, testing or approval. The Contractor shall bear all costs of such inspections, tests or approvals conducted by public authorities. Unless otherwise provided, the Owner shall bear all costs of other inspections, tests or approvals.

7.6.1.1 Unless otherwise stipulated in other Contract Documents, the Contractor shall pay for all utilities required for testing of installed equipment of all of his work and work of each Subcontractor. Boiler fuel other than gas shall be provided by Subcontractor furnishing boilers. Labor and supervision required for making such tests shall be provided at no additional cost to the Owner.

7.6.2 If the Design Consultant or the Construction Program Manager determine that any Work requires special inspection, testing, or approval which Subparagraph 7.6.1 does not include, the Construction Program Manager will instruct the Contractor to order such special inspection, testing or approval, and the Contractor shall give notice as provided in Subparagraph 7.6.1. If such special inspection or testing reveals a failure of the Work to comply (1) with the requirements of the Contract Documents, or (2) with respect to the performance of the Work, with laws, ordinances, rules, regulations, or orders of any public authority having jurisdiction, the Contractor shall bear all costs thereof, including compensation for the Design Consultant's and the Construction Program Manager's and Design Consultant's additional services made necessary by such failure.

7.6.3 Inspections and tests required to establish compliance with the Contract Documents, as provided for in the Contract Documents, will be made by a pre-qualified, independent testing agency selected by the Owner. The cost of the initial services of such agency will be paid by the Owner. When the initial tests indicate non-compliance with the Contract Documents, any subsequent testing occasioned by non-compliance shall be performed by the same agency and the cost thereof shall be borne by the Contractor. Representatives of the testing agency shall have access to the Work at all times. The Contractor shall provide facilities for such access in order that the agency may properly perform its functions.

7.6.4 The independent testing agency, employed by the Owner, shall prepare the test reports, logs, and certificates applicable to the specific inspections and tests and promptly deliver the specified number of copies to the designated parties. Certificates of inspection, testing or approval required by public authorities shall be secured by the Contractor and promptly delivered by him to the Owner, in adequate time to avoid delays in the Work or final payment therefor.

7.6.5 If the Design Consultant or the Construction Program Manager is to observe the inspections, tests or approvals required by the Contract Documents, laws, ordinances, rules, regulations, or order of any public authority having jurisdiction or that are required to establish compliance with the Contract Documents, he will do so promptly and, where practicable, at the normal place of testing.

7.6.6 The Contractor shall pay for and have sole responsibility for inspections or testing performed exclusively for his own convenience.

7.7 UNENFORCEABILITY OF ANY PROVISION

7.7.1 If any provision of this Contract is held as a matter of law to be unenforceable, against public policy or unconscionable, the remainder of the Contract shall be enforceable without such provision.

7.8 ATTORNEYS' FEES AND OTHER EXPENSES

7.8.1 The Contractor hereby agrees that he will not submit, assert, litigate or otherwise pursue any frivolous or unsubstantiated claims or claims he has specifically waived under the terms of the Contract Documents. In the event that the Contractor's claims, or any separate item of a claim, is without substantial justification, the Contractor shall reimburse the Owner, Construction Program Manager or Design Consultant for all costs and expenses associated with defending such claim or separate item, including but not limited to, attorneys' fees, audit costs, accountants' fees, expert witness' fees, additional Construction Program Manager or Design Consultant expenses or services, additional program management expenses and any other consultant costs.

7.8.2 If the Contractor breaches any obligation under the Contract Documents, the Contractor shall reimburse the Owner and Construction Program Manager and Design Consultant for

all costs and expenses incurred by the Owner relating to the lawsuit involving such breach, including but not limited to attorneys' fees, audit costs, accountants' fees, expert witness' fees, additional Construction Program Manager and Design Consultant expenses, additional program management expenses and any other consultant costs.

- 7.8.3 If the Owner, Construction Program Manager or Design Consultant prevails in a claim brought against the Contractor, including but not limited to, claims for fraud or misrepresentation, overpayment, defective work, liquidated or delay damages, and recovery of termination expenses, the Contractor shall reimburse the Owner and Construction Program Manager and Design Consultant for all costs and expenses incurred by them relating to the lawsuit, including but not limited to, attorneys' fees, audit costs, accountants' fees, expert witness' fees, additional Construction Program Manager and Design Consultant expenses, additional program management expenses, and any other consultant costs.

7.9 JESSICA LUNSFORD ACT

- 7.9.1. Effective September 1, 2005, if the Contractor, his employees, or his agents have access to a St. John's County school when students are present, have direct contact with students, or have access to or control of school funds, the Contractor, employee or agent must undergo and pass screening requirements as described in Sections 1012.32 and 435.04, Florida Statutes and comply with Section 1012.465 Florida Statutes as amended by HB 1877, The Jessica Lunsford Act.
- 7.9.2. The Contractor shall insure that he and all his employees, agents, and subcontractors are processed and approved to commence work within the planned schedule. Contract delays due to failure to comply with the Jessica Lunsford Act shall not constitute reasons for adjustments in contract price or contract time.

END OF ARTICLE 7

ARTICLE 8

TIME

8.1 DEFINITIONS

- 8.1.1 Unless otherwise provided, the Contract Time is the period of time allotted in the Contract Documents for Final Completion of the Work as defined in Subparagraph 8.1.4, including authorized adjustments thereto. The Contractor shall complete his Work within Contract Time.

- 8.1.2 The date of commencement of the Work is the date established in a notice to proceed. If there is no notice to proceed, it shall be the date of the Owner-Contractor Agreement or such other date as may be established therein. The Contractor shall not mobilize, commence Work or store materials or equipment on site until: (1) written Notice to Proceed is issued; (2) all bonds and Certificates of Insurance have been executed, delivered to and accepted by the Owner; (3) Contractor has delivered to Owner his as-planned schedule, original job cost estimate, list of sub-contractors and corporate resolution designating his representative; (4) or until the Contractor otherwise receives the Owner's or Construction Program Manager's written consent.
- 8.1.3 The Date of Substantial Completion of the Work is the Date certified by the Design Consultant and the Construction Program Manager when the Work is sufficiently complete, in accordance with the Contract Documents, so the Owner can fully occupy and utilize the Work for the use for which it is intended, with all of the Project's parts and systems operable as required by the Contract Documents. Only incidental corrective work and any final cleaning beyond that needed for the Owner's full use may remain for final completion.
- 8.1.4 The date of Final Completion of the Work is the date certified by the Construction Program Manager, the Design Consultant and the Owner when the Work is totally complete, to include all items listed on the inspection report following substantial completion inspection, in accordance with the Contract Documents and the Owner may fully occupy and utilize all of the Work for the use for which it is intended.
- 8.1.5 The term day as used in the Contract Documents shall mean calendar day unless otherwise specifically designated. All dates shall mean midnight of the indicated day unless otherwise stipulated.

8.2 PROGRESS AND COMPLETION

- 8.2.1 All time limits stated in the Contract Documents are of the essence of the Contract.
- 8.2.2 The Contractor shall begin the Work on the date of commencement as defined in Subparagraph 8.1.2. He shall carry the Work forward expeditiously with adequate forces and shall achieve Substantial Completion and Final Completion within the time frames stated in the Contract Documents.
- 8.2.3 If a date or time of completion is included in the Contract, it shall be the Date of Final Completion as defined in Subparagraph 8.1.4, including authorized extensions thereto, unless otherwise provided.

8.2.4 SPECIFIC DATES

The schedule below contains certain specific dates in addition to date of Notice to Proceed. These dates shall be adhered to and are the last acceptable dates unless modified by mutual agreement between the Contractor and the Owner. All dates indicate

midnight unless otherwise stipulated. The only exceptions to this schedule are defined in paragraph 8.3, DELAYS AND EXTENSIONS OF TIME:

- A. Substantial Completion (Beneficial Occupancy of the Entire Project) **September 22, 2017**

- B. Project Final Completion **September 29, 2017**

8.3 DELAYS AND EXTENSIONS OF TIME

- 8.3.1 The time during which the Contractor is delayed in the performance of the Work, by the acts or omissions of the Owner, the Construction Program Manager, the Design Consultant or their employees or agents, acts of god, unusually severe and abnormal climatic conditions, fires, floods, epidemics, quarantine restrictions, or other conditions beyond the Contractor's control and which the Contractor could not reasonably have foreseen and provided against, shall be added to the time for completion of the Work (i.e., the Contract Time) stated in the Agreement; provided, however, that no claim by the Contractor for an extension of time for delays will be considered unless made in compliance with the requirements of this Article and other provisions of the Contract Documents. Contractor agrees that a change in the Contract Time may only be authorized by a written Change Order authorized and executed by the **St. Johns County School District**. No person has authority to orally or in writing grant any change in the Contract Time except as stated herein.

- 8.3.2 Neither the Owner, the Construction Program Manager, nor the Design Consultant shall be obligated or liable to the Contractor for, and the Contractor hereby expressly waives and releases any claims against the Owner, the Construction Program Manager and the Design Consultant on account of any indirect or direct damages, costs or expenses of any nature which the Contractor, its Subcontractors, or Sub-subcontractors or any other person may incur as a result of any delays, interferences, changes in sequence or the like, which are reasonable, foreseeable, contemplated, or avoidable by Contractor, arising from or out of any act or omission of the Owner, the Contract Program Manager or the Design Consultant, or their agents, employees, consultants, independent contractors or any governmental representative, it being understood and agreed that the Contractor's sole and exclusive remedy in any such events shall be an extension of the Contract Time, but only as determined in accordance with the provisions of the Contract Documents.

- 8.3.3 The Contract Time shall be adjusted only for changes pursuant to Paragraph 12.1, suspension of Work pursuant to Paragraph 3.4 and excusable delays pursuant to Subparagraph 8.3.4. In the event the Contractor requests an extension of the Contract Time, he shall furnish such justification and supporting evidence as the Owner may deem necessary for a determination of whether or not the Contractor is entitled to an extension of time under the provisions of the Contract, and shall further conform to all of the requirements of Section 01311, Construction Schedules and Reports. The burden of proof to substantiate a claim for an extension of the Contract Time shall rest with the Contractor, including evidence that the cause was beyond his control. The Owner shall

base his findings of fact and decision on such justification and supporting evidence and shall advise the Contractor in writing thereof. If the Owner finds that the Contractor is entitled to any extension of the Contract Time, the Owner's determination of the total number of days extension shall be based upon the currently approved progress schedule and on all data relevant to the extension. Such data will be incorporated into the schedule in the form of a revision thereto, accomplished in a timely manner. The Contractor acknowledges and agrees that actual delays (due to said changes, suspension of Work or excusable delays) in activities which, according to the schedule, do not affect the Contract Time, do not have any effect upon the Contract Time and therefore will not be the basis for a change therein. The Contractor acknowledges and agrees that time extensions will be granted only to the extent that excusable delays exceed the available float in the Contractor's schedule. The Contractor acknowledges and agrees that all available float in the Contractor's schedule belongs to the Owner and may be utilized, without additional cost, by the Owner.

8.3.3.1 Extensions in the Contract Time are Change Orders are subject to extension-in-time audit by the Construction Program Manager as follows:

The Contractor agrees that, even though the Owner, Contractor and Design Consultant have previously signed a Change Order containing an extension-in-time resulting from a change in or addition to the Work that said extension in the Contract Time may be adjusted by an audit after the fact by the Construction Program Manager. If such an audit is to be made, the Construction Program Manager must undertake the audit and make a ruling within 30 days after the completion of the Work under the Change Order.

The Contractor agrees that any extension of the Contract Time to which he is entitled arising out of a change order undertaken on a force accounting (labor and materials) basis, shall be determined by an extension-in-time audit by the Construction Program Manager after the Work of the change order is completed. Such rulings shall be made by the Construction Program Manager within 30 days after a request for same is made by the Contractor or Design Consultant, except said 30 days will not start until the Work under the Change Order is completed.

8.3.4 Subject to other provisions of the Contract, the Contractor may be entitled to an extension of the Contract Time (but no increase in the Contract Sum) for delays arising from unforeseeable causes beyond the control and without the fault or negligence of the Contractor, his Subcontractors or suppliers as follows:

- .1 labor disputes and strikes (including strikes affecting transportation), that do, in fact, directly and critically affect the progress of the Work; however, an extension of Contract Time on account of an individual labor strike shall not exceed the number of days of said strike;
- .2 acts of God, tornado, fire, hurricane, blizzard, earthquake, typhoon, or flood that damage completed work or stored materials;

- .3 abnormal inclement weather; however, the Contract Time will not be extended due to normal inclement weather. The time for performance of this Contract, as stated in the Contract Documents, includes an allowance for calendar days which may not be available for construction out-of-doors; for the purposes of this Contract, the Contractor agrees that said number of calendar days per month are to be considered as normal inclement weather. Unless the Contractor can substantiate to the satisfaction of the Owner that there was greater than normal inclement weather considering the full term of the Contract Time using a ten year average of accumulated record mean values from climatological data compiled by the U.S. Department of Commerce, National Oceanic and Atmospheric Administration for the locale of the Project and that such alleged greater than normal inclement weather actually delayed the Work or portions thereof which had an effect upon the Contract Time, the Contractor shall not be entitled to an extension of time. If the total accumulated number of calendar days lost due to inclement weather, from the start of Work until Substantial Completion, exceeds the total accumulated number to be expected for the same period from the aforesaid table, time for completion will be extended by the number of calendar days needed to include the excess number of calendar days lost.
- .4 acts of the public enemy, acts of the state, Federal or local government in its sovereign capacity, and acts of another contractor in the performance of a contract with the Owner relating to the Project.

8.3.5 The Contractor shall not be entitled to and hereby expressly waives any extension of time resulting from any condition or cause unless said claim for extensions of time is made in writing to the Construction Program Manager within seven (7) days of the first instance of delay. Circumstances and activities leading to such claim shall be indicated or referenced in a daily field inspection report for the day(s) affected; otherwise, all such claims are waived and released by the Contractor. In every such written claim, the Contractor shall provide the following information:

- .1 Nature of the delay;
- .2 Date (or anticipated date) of commencement of delay;
- .3 Activities on the progress schedule affected by the delay, and/or new activities created by the delay and their relationship with existing activities;
- .4 Identification of person(s) or organization(s) or event(s) responsible for the delay;
- .5 Anticipated extent of the delay; and
- .6 Recommended action to avoid or minimize the delay.

8.3.6 For the purpose of this contract, the Contractor agrees that he may expect inclement weather for the number of calendar days in accordance with the following table:

.1 in. Precipitation, or more 32 Degrees F., or less

Jan	<u>5</u>	<u>4</u>
Feb	<u>6</u>	<u>2</u>
Mar	<u>5</u>	<u>1</u>
Apr	<u>3</u>	<u>0</u>
May	<u>5</u>	<u>0</u>
June	<u>8</u>	<u>0</u>
July	<u>9</u>	<u>0</u>
Aug	<u>8</u>	<u>0</u>
Sept	<u>10</u>	<u>0</u>
Oct	<u>8</u>	<u>0</u>
Nov	<u>4</u>	<u>1</u>
Dec	<u>4</u>	<u>3</u>

Also the Contractor agrees that the measure of extreme weather during the period covered by this Contract shall be the number of days in excess of those shown for each month in the table above, in which precipitation exceeded .10 inch, or in which the highest temperature was 32 degrees F. or less from the National Weather Station, St. Augustine, Florida, over the same period of time, which is the same source of data used to determine normal weather losses. If the total accumulated number of calendar days lost to inclement weather, from the start of work until the building is enclosed, exceeds the total accumulated number to be expected for the same period from the table above, time for completion will be extended by the number of calendar days needed to include the excess number of calendar days lost. No extension of time will be made for days due to weather occurring after the building is enclosed. For the purpose of this Contract, the term "enclosed" is defined to mean when the building is sufficiently roofed and sealed, either temporarily or permanently, to permit the structure to be heated and the plastering and dry-wall trades to work. The Construction Program Manager shall determine when the structure is "enclosed". The Construction Program Manager shall issue a letter certifying to the Owner, with a copy to the contractor, stating the date the building became enclosed. No change in Contract Sum will be authorized because of adjustment of Contract Time due to weather.

8.3.7 If no schedule or agreement is made stating the dates upon which written interpretations as set forth in Paragraph 2.2 shall be furnished, then no claim for delay shall be allowed on account of failure to furnish such interpretations until twenty days after demand is made for them, and not then unless such claim is reasonable.

8.3.8.1 If the said Contractor shall neglect, fail or refuse to complete the Work within the time herein specified, or any proper extension thereof granted by the Owner, then the Contractor does hereby agree, as a part consideration for the awarding of this contract, to pay the Owner the amount specified in the Contract, not as a penalty but as liquidated damages for such breach of contract as hereinafter set forth, for each and every calendar

day that the Contractor shall be in default after the time stipulated in the contract for completing the work.

8.3.8.2 The said amount is fixed and agreed upon by and between the Contractor and the Owner because of the impracticability and extreme difficulty of fixing and ascertaining the actual damages the Owner would in such event sustain, and said amount is agreed to be the amount of damages which the Owner may sustain and said amount shall be retained from time to time by the Owner from current periodical estimates.

8.4 RESPONSIBILITY FOR COMPLETION

8.4.1 The Contractor shall furnish such manpower, materials, facilities and equipment and shall work such hours, including night shifts, overtime operations and Sundays and holidays, as may be necessary to insure the progress and completion of the Work in accordance with the approved and currently updated progress schedule. If Work actually in place falls behind the currently updated and approved progress schedule and it becomes apparent from the current schedule that the Work will not be completed within the Contract Time, the Contractor agrees that he will, as necessary, take some or all of the following actions at no additional cost to the Owner, as required to eliminate the backlog of Work:

- .1 increase manpower in quantities and crafts as necessary;
- .2 increase the number of working hours per shift, shifts per day, working days per week, the amount of equipment, or any combination of the foregoing; and/or
- .3 reschedule activities to achieve maximum practical concurrence.

8.4.2 The Construction Program Manager may require the Contractor to submit a recovery schedule in accordance with Section 01311 of the Specifications, demonstrating his program and proposed plan to make up the lag in scheduled progress and to ensure completion of the Work within the Contract Time. If the Construction Program Manager finds the proposed plan not acceptable, he may require the Contractor to submit a new plan. If the actions taken by the Contractor or the second plan proposed are not satisfactory, the Construction Program Manager may require the Contractor to take any of the actions set forth in this Paragraph 8.4 without additional cost to the Owner, to make up the lag in scheduled progress.

8.4.3 Failure of the Contractor to substantially comply with the requirements of this Paragraph 8.4 may be considered grounds for a determination by the Owner, pursuant to Article 14, that the Contractor is failing to prosecute the Work with sufficient diligence to ensure its completion within the Contract Time.

8.5 LIQUIDATED DAMAGES FOR DELAY

8.5.1 The damages incurred by the Owner due to the Contractor's failure to complete the Work within required Milestone dates and the Contract Time, including any extensions thereof,

shall be in the amount set forth in the Owner-Contractor Agreement, for each consecutive calendar day beyond the Milestone dates or the Contract Time (Sundays and all holidays included) for which the Contractor shall fail to complete the Work.

END OF ARTICLE 8

ARTICLE 9

PAYMENTS AND COMPLETION

9.1 CONTRACT SUM

9.1.1 The Contract Sum is stated in the Owner-Contractor Agreement and, including authorized adjustments thereto, is the total amount payable by the Owner to the Contractor for the performance of the Work under the Contract Documents.

9.2 SCHEDULE OF VALUES

9.2.1 Before the first Application for Payment, the Contractor shall submit to the Owner a schedule of values allocated to the various portions of the Work, as set forth in Division 1, Section 01311 of the General Requirements entitled "Schedules and Reports" and supported by such data to substantiate its accuracy as the Construction Program Manager and the Owner may require. This schedule, unless objected to by the Owner, shall be used as a basis for the Contractor's Applications for Payment and only for this purpose. If approved by the Owner, the Contractor may include in his schedule of values a line item for mobilization which shall include a reasonable amount of mobilization for the Contractor and his subcontractors. The Contractor shall not front-end load his schedule of values, and such schedule shall set forth Contractor's best evaluation of the value of the various segments of the Work. Surety hereby consents to, agrees and accepts Contractor's schedule of values.

9.3 APPLICATIONS FOR PAYMENT

9.3.1 Prior to the date for each progress payment established in the Owner-Contractor Agreement, the Contractor, in accordance with Division 1, Section 01311 of the General Requirements entitled "Schedules and Reports", shall submit to the Construction Program Manager an itemized Application for Payment, notarized if required, supported by such data substantiating the Contractor's right to payment as the Construction Program Manager and the Design Consultant may require, including but not limited to the Contractor's certification that all work for which payment is requested has been completed in full in accordance with the Contract Documents, and reflecting retainage, if any, as provided elsewhere in the Contract Documents. The Contractor shall also swear to and certify that he has paid all due and payable amounts due to subcontractors and materialmen for which previous certificates for payment were issued and payments received from the Owner.

9.3.2 The Owner will retain ten percent of the amount of all progress payments until the Work is Finally Completed and accepted, whether or not the Owner has occupied any or all of the Project before such time. However, if the Owner, at any time after fifty percent of the Work has been completed, finds that satisfactory progress is being made, he may, but is not required to, authorize payment to the Contractor in full of each Progress Payment for Work performed beyond the fifty percent stage of completion.

9.3.3 Payments may be made by the Owner at his discretion, on account of materials or equipment not incorporated in the Work but delivered and suitably stored at the site by the Contractor. Payments for materials or equipment stored on the site shall only be considered upon submission of the Contractor of satisfactory evidence (for example, releases or paid invoices from the Seller) that he has acquired title to such material, that it will be utilized on the Work under this Contract and that it is satisfactorily stored, protected, and insured or that other procedures satisfactory to the Owner that will protect the Owner's interests have been taken. Materials once paid for by the Owner become the property of the Owner and may not be removed from the work site without the Owner's written permission.

9.3.3.1 Owner will be under no obligation to make payment to the Contractor on account of materials or equipment not incorporated in the Work but delivered and stored at the site unless the Contractor, in his Schedule of Values, includes line items for such delivered and stored materials or equipment.

9.3.3.2 It is specifically understood and agreed that an inspection and approval of the materials by the Owner, Construction Program Manager, the Design Consultant or any agency retained by any of them shall not in any way subject the Owner to pay for the said materials or any portion thereof, even though incorporated in the Work, if said materials shall in fact turn out to be unfit to be used in the Work, nor shall such inspection be considered as any waiver of objection to the Work on account of the unsoundness or imperfection of the material used.

9.3.3.3 Unless otherwise provided for elsewhere in the Contract Documents, no payments will be made for any materials or equipment stored off or away from the Work Site.

9.3.4 The Contractor warrants that title to all Work, materials and equipment covered by an Application for Payment will pass to the Owner either by incorporation in the construction or upon the receipt of payment by the Contractor, whichever occurs first, free and clear of all liens, claims, security interests or encumbrances, hereinafter referred to in this Article 9 as "liens"; and that no Work, materials or equipment covered by an Application for Payment will have been acquired by the Contractor, or by any other person performing Work at the site or furnishing materials and equipment for the Project, subject to an agreement under which an interest therein or an encumbrance thereon is retained by the seller or otherwise imposed by the Contractor or such other person.

9.4 CERTIFICATES FOR PAYMENT

- 9.4.1 The Design Consultant and the Construction Program Manager will, after receipt of the Contractor's Application for Payment, and within the time set forth in Division 1, Section 01311 of the General Requirements entitled "Schedules and Reports", either jointly issue a Certificate for Payment to the Owner, with a copy to the Contractor, for such amount as the Construction Program Manager and the Design Consultant determine is properly due, or notify the Contractor in writing of their reasons for withholding a Certificate as provided in Subparagraph 9.6.1. The Design Consultant shall at all times seek the advice of the Construction Program Manager regarding said applications for payment.
- 9.4.2 The submission and approval of the progress schedule and monthly updates thereof as required by Division 1, Section 01311 of the General Requirements entitled "Schedules and Reports", shall be a condition precedent to the processing and payment of any Application for Payment. The Contractor shall be entitled to progress payments only as determined from the currently approved and updated schedule.
- 9.4.3 The signing of a Certificate for Payment will constitute a representation by the Construction Program Manager and the Design Consultant to the Owner, based on their observations at the site pursuant to their agreements with the Owner, and the data comprising the Application for Payment, that the Work has progressed to the point indicated; that, to the best of their knowledge, information and belief, the quality of the Work is in accordance with the Contract Documents (subject to an evaluation of the Work for conformance with the Contract Documents upon Substantial Completion, to the results of any subsequent tests required by or performed under the Contract Documents, to minor deviations from the Contract Documents correctable prior to completion, and to any specific qualifications stated in their Certificate); and that the Contractor is entitled to payment in the amount certified. However, by signing a Certificate for Payment, the Construction Program Manager and the Design Consultant shall not thereby be deemed to represent that either has made exhaustive or continuous on-site inspections to check the quality or quantity of the Work or that either has reviewed the construction means, methods, techniques, sequences, or procedures, or that either has made any examination to ascertain how or for what purpose the Contractor has used the moneys previously paid on account of the Contract Sum.

9.5 PROGRESS PAYMENTS

- 9.5.1 After a Certificate for Payment has been issued, the Owner shall make payment in the manner and within the time provided in the Contract Documents.
- 9.5.2 The Contractor shall promptly pay each Subcontractor (including suppliers, laborers, and material-men) performing labor or furnishing material for the Work, upon receipt of payment from the Owner, out of the amount paid to the Contractor on account of such Subcontractor's Work, the amount to which said Subcontractor is entitled, reflecting the percentage actually retained, if any, from payments to the Contractor on account of such Subcontractor's Work. The Contractor shall, by an appropriate agreement with each

Subcontractor, also require each Subcontractor to make payments to his Sub-subcontractors in similar manner.

- 9.5.3 The Owner may, on request and at his discretion, furnish to any Subcontractor, if practicable, information regarding the percentages of completion or the amounts applied for by the Contractor and the action taken thereon by the Construction Program Manager or the Design Consultant on account of Work done by such Subcontractor.
- 9.5.4 Neither the Owner, the Construction Program Manager, nor the Design Consultant shall have any obligation to pay or to see to the payment of any moneys to any Subcontractor or materialman.
- 9.5.5 No Certificate for a progress payment, nor any progress payment, nor any partial or entire use or occupancy of the Project by the Owner, shall constitute an acceptance of any Work not in accordance with the Contract Documents.
- 9.5.6 Contractor acknowledges that he may not lien Owner's interest in the Project site, pursuant to Florida law. Contractor agrees to advise all subcontractors and materialmen of the non-lienable nature of the project and to further furnish each such person or entity a copy of the Labor and Material Payment Bond for the project.

9.6 PAYMENTS WITHHELD

- 9.6.1 The Design Consultant and the Construction Program Manager may decline to certify payment and may withhold their Certificate in whole or in part, to the extent necessary reasonably to protect the Owner, if in their opinion they are unable to make representations to the Owner as provided in Subparagraph 9.4.3. If the Construction Program Manager and the Design Consultant are unable to make representations to the Owner as provided in Subparagraph 9.4.3 and to certify payment in the amount of the Application, they will notify the Contractor as provided in Subparagraph 9.4.1. If the Contractor and the Design Consultant cannot agree on a revised amount, the Construction Program Manager and the Design Consultant will promptly issue a Certificate for Payment for the amount for which they are able to make such representations to the Owner. The Design Consultant and the Construction Program Manager may also decline to certify payment or because of subsequently discovered evidence or subsequent observations, they may nullify the whole or any part of any Certificate for Payment previously issued to such extent as may be necessary in their opinion to protect the Owner from loss, because of:

- .1 defective work not remedied,
- .2 third party claims filed, whether in court, in arbitration or otherwise, or reasonable evidence indicating the probability of filing of such claims,
- .3 failure of the Contractor to make payments properly to Subcontractors or for labor, materials or equipment,

- .4 reasonable evidence that the Work cannot be completed for the unpaid balance of the Contract Sum,
- .5 damage to the Owner or another contractor,
- .6 reasonable evidence that the Work will not be completed within the Contract Time, or within any Contract Milestones as established in the Contract Documents,
- .7 failure or refusal of the Contractor to carry out the Work in accordance with or to otherwise substantially or materially comply with the Contract Documents,
- .8 failure or refusal of the Contractor to properly schedule and coordinate the Work, to provide progress schedules, reports and updates, or to otherwise fully comply with Division 1, Section 01311 of the General Requirements entitled "Schedules and Reports", or
- .9 failure or refusal of the Contractor to fully comply with the provisions of Article 6.2 requiring the Contractor to direct certain claims to separate contractors and to defend and indemnify the Owner, the Construction Program Manager and/or the Design Consultant in the event separate contractors file certain claims.

9.6.2 When the above grounds in Subparagraph 9.6.1 are removed, payment shall be made for amounts withheld because of them.

9.7 FAILURE OF PAYMENT

9.7.1 If the Owner does not make payment to the Contractor within the forty (40) calendar days after receipt of the Contractor's Approved Application for Payment by the Design Consultant and the Construction Program Manager through no fault of the Contractor, and the Owner otherwise not being entitled under the Contract Documents or applicable law to withhold payment, then the Contractor may, upon seven (7) additional days' written notice to the Owner and the Construction Program Manager, stop the Work until payment of the amount owing according to the Contract Documents has been received.

9.8 SUBSTANTIAL COMPLETION

9.8.1 When the Contractor considers that the Work, is substantially complete as defined in Subparagraph 8.1.3, the Contractor shall prepare for submission to the Owner a list of items which in his opinion are to be completed or corrected and shall request in writing that the Design Consultant and the Construction Program Manager perform a Substantial Completion inspection. The Design Consultant and the Construction Program Manager shall review the Contractor's list and shall compile an inspection report of items to be corrected and completed. The failure to include any items on such list does not alter the responsibility of the Contractor to complete all Work in accordance with the Contract

Documents. When the Design Consultant on the basis of an inspection determines that the Work is substantially completed then the Design Consultant will prepare a Certificate of Substantial Completion which shall establish the Date of Substantial Completion, shall state the responsibilities of the Owner and the Contractor for security, maintenance, heat, utilities, damage to the Work, and insurance, and shall fix the time within which the Contractor shall complete the items listed therein. Warranties required by the Contract Documents shall commence on the Date of Final Completion of the Work. The Certificate of Substantial Completion shall be submitted to the Owner and the Contractor for their written acceptance of the responsibilities assigned to them in such Certificate.

- 9.8.2 Upon Substantial Completion of the Work and upon application by the Contractor and certification by the Construction Program Manager and the Design Consultant, the Owner may make payment, reflecting adjustment in retainage, if any, for such work or portion thereof, as provided in the Contract Documents.
- 9.8.3 The acceptance of any Substantial Completion payment shall constitute a waiver and full release of all claims by the Contractor except those previously made in writing and identified by the Contractor as unsettled at the time of the Application for Payment for Substantial Completion, and except for the retainage sums due at final completion and acceptance.
- 9.8.4 The Contractor shall have thirty (30) working days from the Date of Substantial Completion to complete all items on the inspection report to the satisfaction of the Owner, Design Consultant and Construction Program Manager. The Owner and the Construction Program Manager shall have the option to correct or conclude any and all items on the inspection report not completed by the Contractor within thirty (30) working days from the Date of Substantial Completion by utilizing its own forces or by hiring others. The cost of such correction of remaining inspection report items by the Owner or others shall be deducted from the final payment to the Contractor.
- 9.8.5 The issuance of the Certificate of Substantial Completion does not indicate final acceptance of the project by the Owner, and the Contractor is not relieved of any responsibility for the project except as specifically stated in the Certificate of Substantial Completion.
- 9.8.6 Should the Design Consultant and the Construction Program Manager determine that the work or a designated portion thereof is not substantially complete, they shall provide the Contractor with written notice stating why the project or designated portion is not substantially complete. The Contractor shall expeditiously complete the Work and shall re-request in writing that the Design Consultant and the Construction Program Manager perform a Substantial Completion inspection. Costs, if any, associated with such inspection shall be assessed to the Contractor.
- 9.9 FINAL COMPLETION AND FINAL PAYMENT

9.9.1 Upon receipt of the documentation required by Article 9.8, and of written notice that the Work is ready for final inspection and acceptance and upon receipt of a final Application for Payment, the Design Consultant and the Construction Program Manager will promptly make such inspection and, when they find the Work acceptable under the Contract Documents and the Contract fully performed, they will jointly issue a final Certificate of Payment stating that to the best of their knowledge, information and belief, and on the basis of their observations and inspections, the Work has been completed in accordance with the terms and conditions of the Contract Documents and that the entire balance found to be due the Contractor, and noted in said final Certificate, is due and payable. The final Certificate for Payment will constitute a further representation that the conditions precedent to the Contractor's being entitled to final payment as set forth in Subparagraph 9.8 have been fulfilled. Payment shall be made in full to the Contractor within thirty (30) calendar days of the date of the final Certificate of Payment provided that the requirements of Article 9 have been fulfilled, except for an amount mutually agreed upon for any work remaining uncompleted for which the Owner is entitled a credit under the Contract Documents. Owner shall have no obligation to pay any Applications for Progress or Final Payments absent an approved Certificate of Payment from the Design Consultant and the Construction Program Manager.

9.9.2 Neither the final payment nor the remaining retained percentage shall become due until the Work is free and clear of any and all liens and the Contractor submits to the Owner:

- .1 an affidavit from Contractor and all subcontractors, sub-subcontractors and materialmen that all payrolls, bills for materials and equipment, and other indebtedness connected with the Work have been paid or otherwise satisfied;
- .2 consent of surety, if any, to final payment;
- .3 if required by the Construction Program Manager, other data establishing payment or satisfaction of all such obligations, such as receipts, releases and waivers of liens arising out of the Contract, to the extent and in such form as may be designated by the Construction Program Manager;
- .4 as-built drawings in the form required by the Contract Documents after having been delivered to and approved by the Design Consultant, operation and maintenance manuals and other project close-out submittals, as required by the Contract Documents; and
- .5 a written certification that:
 - .1 the Contractor has reviewed the requirements of the Contract Documents,
 - .2 the Work has been inspected by the Contractor for compliance with all requirements of the Contract Documents,

- .3 pursuant to this inspection, the Contractor certifies and represents that the Work complies in all respects with the requirements of the Contract Documents,
- .4 the Contractor further certifies and represents that all equipment and systems have been installed in accordance with the Contract Documents and have been tested in accordance with specification requirements and are operational, and
- .5 the Contractor hereby certifies and represents that the Work is complete in all respects and ready for final inspection.

9.9.3 If any Subcontractor refuses to furnish a release or waiver required by the Owner, the Contractor may furnish a bond satisfactory to the Owner to indemnify him against any loss. If any such lien or claim remains unsatisfied after all payments are made, the Contractor shall refund to the Owner all moneys that the latter may be compelled to pay in discharging such lien or claim, including all costs and reasonable attorneys' fees. The Owner may withhold from the final payment any sum that the Owner has reason to believe may be needed to satisfy any claim arising from the Work. The Owner may deduct from the final payment an amount equal to any costs, expenses and attorneys' fees incurred by the Owner associated with any lien or claim by a subcontractor, sub-subcontractor, material supplier, laborer, etc.

9.9.4 The making of final payment shall not constitute a waiver of any claims by the Owner against the Contractor.

9.9.5 The acceptance of final payment shall constitute a waiver and release of all claims by the Contractor.

9.10 OWNER'S RIGHT TO OCCUPY INCOMPLETE WORK

9.10.1 Should the Project, or any portion thereof, be incomplete for Beneficial Occupancy or Final Completion at the scheduled date or dates, the Owner shall have the right to occupy any remaining portion of the Project. In such an event, the Contractor shall not be entitled to any extra compensation on account of said occupancy by the Owner or by the Owner's normal full use of that portion of the Project, nor shall the Contractor interfere in any way with said normal full use of that portion of the Project. Further, in such an event, the Contractor shall not be entitled to any extra compensation on account of the Owner's occupancy and use of the Project, nor shall the Contractor be relieved of any responsibilities of the Contract including the required times of completion. Such occupancy by the Owner does not constitute Beneficial Occupancy or Final Completion.

9.11 LIQUIDATED DAMAGES

9.11.1 Should the Contractor fail to substantially complete the Work on or before the date stipulated for Substantial Completion (or such later date as may result from extension of time granted by Owner), he shall pay the Owner, as liquidated damages, the sum of **\$100** for each consecutive calendar day that terms of the contract relating to obtaining

Substantial Completion remain unfulfilled beyond the date allowed by the Contract, which sum is agreed upon as a reasonable and proper measure of damages which the Owner will sustain per day by failure of the Contractor to complete work within time as stipulated; it being recognized by the Owner and the Contractor that the injury to the Owner which could result from a failure of the Contractor to complete on schedule is uncertain and cannot be computed exactly. In no way shall costs for liquidated damages be construed as a penalty on the Contractor.

- 9.11.2 For each consecutive calendar day that the Work remains incomplete after the date established for Final Completion, the Owner will retain from the compensation otherwise to be paid to the Contractor the sum of **\$500**. This amount is the minimum measure of damages the Owner will sustain by failure of the Contractor to complete all remedial work, correct deficient work, clean up the project and other miscellaneous tasks as required to complete all work specified. This amount is in addition to the liquidated damages prescribed above and shall be added to such damages for any period of time that the Contractor is late in achieving both Substantial and Final Completion.

END OF ARTICLE 9

ARTICLE 10

PROTECTION OF PERSONS AND PROPERTY

10.1 SAFETY PRECAUTIONS AND PROGRAMS

- 10.1.1 Neither the Owner, the Construction Program Manager, the Design Consultant, nor their agents, employees or representatives are responsible for the means, methods, techniques, sequences or procedures utilized by the Contractor, or for safety precautions and programs in connection with the Work. The Contractor shall be solely responsible for initiating, maintaining and supervising the means, methods, techniques, sequences, procedures and all safety precautions and programs in connection with the Work. This requirement applies continuously throughout the Contract performance, until Final Payment is made, and is not limited to regular working hours.

10.2 SAFETY OF PERSONS AND PROPERTY

- 10.2.1 The Contractor shall take all reasonable precautions for the safety of, and shall provide all reasonable protection to prevent damage, injury or loss to:

- .1 all employees on the Work and all other persons who may be affected thereby;
- .2 all the Work and all materials and equipment to be incorporated therein, whether in storage on or off the site, under the care, custody or control of the Contractor or any of his Subcontractors or Sub-subcontractors, machinery, equipment and all hazards shall be guarded or eliminated in accordance with all applicable safety regulations; and

.3 other property at the site or adjacent thereto, including trees, shrubs, lawns, walks, pavements, roadways, structures and utilities not designated for removal, relocation or replacement in the course of construction.

10.2.2 The Contractor shall give all notices and comply with all applicable laws, ordinances, permits, rules, regulations and lawful orders of any public authority bearing on the safety or persons or property or their protection from damage, injury or loss. Contractors shall comply with the requirements of the Trench Safety Act, Chapter 553, Florida Statutes. Each specific subcontract within the scope of such act shall be in compliance with the Act and Contractor hereby acknowledges his bid complies with and was prepared in accordance with the Act.

10.2.2.1 The Contractor shall at all times safely guard the Owner's property from injury or losses in connection with the Contract. He shall at all times safely guard and protect his own work and adjacent property as provided by law and the Contract Documents, from damage. All passageways, guard fences, lights and other facilities required for protection by applicable safety regulations must be provided and maintained by the Contractor.

10.2.3 The Contractor shall erect and maintain, as required by existing conditions and progress of the Work, all reasonable safeguards for safety and protection, including posting danger signs and other warnings against hazards, promulgating safety regulations and notifying owners and users of adjacent utilities.

10.2.4 When the use or storage of explosives or other hazardous materials or equipment is necessary for the execution of the Work, the Contractor shall exercise the utmost care and shall carry on such activities under the supervision of properly qualified personnel.

10.2.5 The Contractor shall promptly remedy at his own cost and expense all damage or loss to any property referred to in Clauses 10.2.1.2 and 10.2.1.3 caused in whole or in part by the Contractor, any Subcontractor, any Sub-subcontractor, or anyone directly or indirectly employed by any of them, or by anyone for whose acts any of them may be liable and for which the Contractor is responsible under Clauses 10.2.1.2 and 10.2.1.3. The foregoing obligations of the Contractor are in addition to his obligations under Paragraph 4.21. The Contractor shall perform such restoration by underpinning, repairing, rebuilding, replanting, or otherwise restoring as may be required or directed by the Construction Program Manager or Owner, or shall make good such damage in a satisfactory and acceptable manner. In case of failure on the part of the Contractor to promptly restore such property or make good such damage, the Construction Program Manager or Owner may, upon two (2) calendar days written notice, proceed to repair, rebuild or otherwise restore such property as may be necessary and the cost thereof, or a sum sufficient in the judgment of the Construction Program Manager or Owner to reimburse the owners of property so damaged, will be deducted from any monies due or to become due the Contractor under the Contract.

- 10.2.6 The Contractor is responsible for the proper packing, shipping, handling and storage (including but not limited to shipment or storage at the proper temperature and humidity) of materials to be incorporated in the Work, so as to insure the preservation of the quality and fitness of the material for proper installation and incorporation in the Work, as required by the Contract Documents. For example, but not by way of limitation, Contractor shall, when necessary, place material on wooden platforms or other hard and clean surfaces and not on the ground and/or place such material under cover in any appropriate shelter or facility. Stored materials or equipment shall be located so as to facilitate proper inspection. Material and equipment which is delivered crated shall remain crated until ready for installation. Lawns, grass plots or other private property shall not be used for storage purposes without the written permission of the owner or lessee unless otherwise within the terms of the easements obtained by the Owner.
- 10.2.6.1 It shall be the responsibility of the Contractor in his preparation of phasing schedule of work operations after consulting with the other contractors to designate areas in which each contractor may store materials. Areas designed shall meet with the approval of the Architect.
- 10.2.7 The Contractor shall give notice in writing at least 48 hours before breaking ground, to all persons, Public Utility Companies, owners of property having structures or improvements in proximity to site of the Work, superintendents, inspectors, or those otherwise in charge of property, streets, water pipes, gas pipes, sewer pipes, telephone cables, electric cables, railroads or otherwise, who may be affected by the Contractor's operation, in order that they may remove any obstruction for which they are responsible and have representative on site to see that their property is properly protected. Such notice does not relieve the Contractor of responsibility for all damages, claims, or defense or indemnification of all actions against Owner resulting from performance of such work in connection with or arising out of Contract.
- 10.2.8 Contractor shall field locate all utilities and acknowledges that all utilities are not necessarily shown in the Contract Documents, or may be incorrectly located thereon. The Contractor shall protect all utilities encountered while performing its work, whether indicated on the Contract Drawings or not. The Contractor shall maintain utilities in service until moved or abandoned. The Contractor shall exercise due care when excavating around utilities and shall restore any damaged utilities to the same condition or better as existed prior to starting the Work, at no cost to the Owner. The Contractor shall maintain operating utilities or other services, even if they are shown to be abandoned on the Contract Drawings, in service until new facilities are provided, tested and ready for use.
- 10.2.9 The Contractor shall return all improvements on or about the site and adjacent property which are not shown to be altered, removed or otherwise changed to conditions which existed prior to starting work.
- 10.2.10 The Contractor shall protect the Work, including but not limited to, the site, stored materials and equipment, excavations, and excavated or stockpiled soil or other material,

intended for use in the Work, and shall take all necessary precautions to prevent or minimize damage to same or detrimental effect upon his performance or that of his subcontractors, caused by or due to rain, snow, ice, run-off, floods, temperature, wind, dust, sand and flying debris; for example, but not by way of limitation, Contractor shall, when necessary, utilize temporary dikes, channels or pumping to carry-off divert or drain water, and shall as necessary tie-down or otherwise secure the Work and employ appropriate covers and screens.

10.2.11 The Contractor shall designate a responsible member of his organization at the site whose duty shall be the prevention of accidents and the protection of material, equipment and property. This person shall be the Contractor's superintendent unless otherwise designated by the Contractor in writing to the Owner.

10.2.12 The Contractor shall not load or permit any part of the Work to be loaded so as to endanger its safety.

10.2.13 Notification to the Contractor by the Owner, the Construction Program Manager or the Design Consultant of a safety violation will in no way relieve the Contractor of sole and complete responsibility for the correctness of said violation or of sole liability for the consequences of said violation.

10.3 EMERGENCIES

10.3.1 In any emergency affecting the safety of persons or property, the Contractor shall act, at his discretion, to prevent threatened damage, injury or loss. The Contractor shall notify the Owner and the Construction Program Manager of the situation and all actions taken immediately thereafter. If, in the opinion of the Contractor, immediate action is not required, the Contractor shall notify the Owner and Construction Program Manager of the emergency situation and proceed in accordance with the Owner's or Construction Program Manager's instructions. Provided, however, if any loss, damage, injury or death occurs that could have been prevented by the Contractor's prompt and immediate action, the Contractor shall be fully liable for all costs, damages, claims, actions, suits, attorney's fees and all other expenses arising therefrom or relating thereto. Any additional compensation or extension of time claimed by the Contractor on account of emergency work shall be determined as provided in Article 12 for Changes in the Work.

END OF ARTICLE 10

ARTICLE 11

INSURANCE

11.1 CONTRACTOR'S LIABILITY INSURANCE

- 11.1.1 The Contractor shall purchase and maintain in companies properly licensed and qualified to do business in the State of Florida and acceptable to the Owner such non-surplus lines of insurance as will protect him, the Owner, the Construction Program Manager, the Design Consultant and their agents, representatives, and employees from claims set forth below which may arise out of or result from the Contractor's operations under the Contract, whether such operations be by himself or by any Subcontractor or by anyone directly or indirectly employed by any of them, or by anyone for whose acts any of them may be liable:
- .1 claims under worker's or workmen's compensation, disability benefit and other similar employee benefit acts (with Workmen's Compensation and Employer's Liability Insurance in amounts not less than those necessary to meet the statutory requirements of the state having jurisdiction over the Work);
 - .2 claims for damages because of bodily injury, sickness or disease, or death of his employees; the Contractor will require his Subcontractors to similarly provide Workmen's Compensation Insurance for all of the latter's employees;
 - .3 claims for damages because of bodily injury, sickness or disease, or death of any person other than his employees;
 - .4 claims for damages insured by usual personal injury liability coverage which are sustained (1) by any person as a result of an offense directly or indirectly related to the employment of such person by the Contractor, or (2) by any other person;
 - .5 claims for damages, other than to the Work itself, because of injury to or destruction of tangible property, including loss of use resulting therefrom; and
 - .6 claims for damages because of bodily injury or death of any person or property damage arising out of the ownership, maintenance or use of any motor vehicle.
- 11.1.2 The insurance required by Subparagraph 11.1.1 shall be primary and noncontributing to any insurance possessed or procured by the Owner, and limits of liability shall be not less than those set forth in the Supplementary Conditions of this Contract or required by law, whichever is greater.
- 11.1.3 The insurance required by Subparagraph 11.1.1 shall include contractual liability insurance applicable to the Contractor's obligations under Paragraph 4.21.
- 11.1.4 Without limiting the above during the term of the Contract, the Contractor shall, at his own expense, purchase and maintain the following insurance with companies licensed to do business in the jurisdiction in which the Project is located and satisfactory to the Owner:
- .1 Workmen's Compensation including Occupational Disease and Employer's Insurance.

- a. Statutory - Amounts and coverage as required by **State of Florida** Workers' Compensation Laws;
 - b. Employers Liability - At least \$500,000 each accident;
- .2 Public Contractor's Liability and Property Damage Insurance - The Contractor shall take out and maintain during the life of this Contract such Public Contractor's Liability and Property Damage Insurance as shall protect him and any Subcontractor performing work under this Contract from claims for damages for personal injury including accidental death, as well as from claims for personal property damage which may arise from operations under this Contract, whether such operations be by himself or by any Subcontractor or by anyone directly or indirectly employed by either of them. The Contractor shall procure insurance coverage for direct operations, sublet work, elevators, contractual liability and completed operations with limits not less than those stated below:
- a. Bodily Injury Liability
 - \$ 500,000 Per Person
 - \$ 1,000,000 Per Occurrence
 - b. Property Damage Liability
 - \$ 500,000 Per Person
 - \$ 1,000,000 Per Occurrence
 - \$ 2,000,000 Aggregate
 - c. Personal Injury
 - \$ 500,000 Per Person
 - \$ 2,000,000 Aggregate
- .3 Property Damages, including Broad Form Property Damage and Explosion, Collapse, Underground property damage coverages, and blasting; in the amounts noted in paragraph 11.1.4.2;
- .4 Completed Operations and Product Liability: Continuous coverage in force for one year after completion of work in the amounts noted in paragraph 11.1.4.2;
- .5 Comprehensive Automobile Liability Insurance, including coverage for owned, non-owned and hired vehicles - with limits not less than those stated below:
- a. Bodily Injury Liability
 - \$ 500,000 Each Person
 - \$ 1,000,000 Each Occurrence;
 - b. Property Damage Liability
 - \$ 1,000,000 Each Occurrence;

- c. Excess/umbrella policy raising the above limits to
\$ 1,000,000; and
- .6 The Contractor shall purchase and maintain during the life of this Contract complete Owner's Protective Liability Insurance in amounts as specified below. Insurance shall be taken out in the name of the Owner.
 - a. Bodily Injury
 - \$ 1,000,000 Each Occurrence
 - \$ 2,000,000 Aggregate
 - b. Property Damage
 - \$ 1,000,000 Each Occurrence
 - \$ 2,000,000 Aggregate Limit
 - c. Personal Injury
 - \$ 1,000,000 Each Occurrence
 - \$ 2,000,000 General Aggregate
- .7 Liability insurance may be arranged by Comprehensive General Liability and Comprehensive Automobile Liability policies for the full limits required; Comprehensive General Liability Insurance may be arranged under a single policy for the full limits required or by a combination of underlying policies with the balance provided by an excess of umbrella liability policy.
- 11.1.5 The insurance required by Subparagraph 11.1 shall be written for not less than any limits of liability specified in the Contract Documents, or required by law, whichever is greater.
- 11.1.6 All certificates of Insurance acceptable to the Owner shall be filed with the Owner prior to commencement of the Work. These Certificates shall contain a provision that coverages afforded under the policies will not be canceled until at least thirty (30) days' prior written notice has been given to the Owner. The Contractor shall not commence work under this Contract until he has obtained all the insurance required hereunder and such insurance has been approved by the Owner, nor shall the Contractor allow any subcontractor to commence work on his subcontract until all similar insurance required of the subcontractor has been so obtained and approved. Approval of the insurance by the Owner shall not relieve or decrease the liability of the Contractor hereunder.
- 11.1.7 Regarding Property Damage
Include Broad Form Property Damage Endorsement wherein any exclusions relating to loss or damage due to explosion, collapse, or underground property damage have been removed.
- 11.2 PROPERTY INSURANCE

- 11.2.1 The Contractor shall purchase and at all times maintain such insurance as will protect the Contractor, the Owner, the Construction Program Manager, the Owner's representatives, agents and employees, the Design Consultant, Subcontractors and Sub-subcontractors from loss or damage to Work or property in the course of construction, including all machinery, materials and supplies on the premises or in transit thereto and intended to become a part of the finished work until acceptance by the Owner. This insurance shall be in the form of "Builders All- Risk", "All-Risk Installation Floater", or equivalent. The Contractor shall cause such policy or policies of insurance required under this Subparagraph to be endorsed so as to provide that the insurer or insurers waive any right of subrogation against the Owner. Any deductible provision in such insurance shall not exceed the amount set forth in the Supplementary Conditions of the Contract. Notwithstanding any such deductible provision, the Contractor shall remain solely liable for the full amount of any item covered by such insurance.
- 11.2.2 Any loss insured under Subparagraph 11.2.1 is to be adjusted with the Owner and made payable to the Owner as trustee for the insureds, as their interests may appear, subject to the requirements of any applicable mortgagee clause and of Subparagraph 11.2.5. The Contractor shall pay each Subcontractor a just share of any insurance moneys received by the Contractor, and by appropriate agreement, written where legally required for validity, shall require each Subcontractor to make payments to his Sub-subcontractors in similar manner.
- 11.2.3 The Owner and Contractor waive all rights against each other for damages caused by fire or other perils to the extent covered by insurance obtained pursuant to this Paragraph 11.2, or any other property insurance applicable to the Work, except such rights as they may have to the proceeds of such insurance held by the Owner as trustee. The Contractor shall require, by appropriate agreement, written where legally required for validity, similar waivers in favor of the Owner and the Contractor by Subcontractors and Sub-subcontractors. With respect to the waiver of rights of recovery, the term Owner shall be deemed to include, to the extent covered by property insurance applicable thereto, his consultants, employees, and agents and representatives including the Design Consultant and Construction Program Manager and the Construction Program Manager's consultants, employees and agents and the Design Consultant and his consultants, employees and agents. The Contractor waives as against any separate contractor described in Article 6 all rights for damages caused by fire or other perils in the same manner as is provided above as against the Owner. The Owner shall require, by appropriate agreement, written where legally required for validity, similar waivers in favor of the Contractor by any separate contractor and his subcontractors and sub-subcontractors.
- 11.2.4 If required in writing by any party in interest, the Owner as trustee shall, upon the occurrence of an insured loss, give bond for the proper performance of his duties. He shall deposit in a separate account any money so received, and he shall distribute it in accordance with such agreement as the parties in interest may reach, or in accordance with a court order or award. If after such loss no other special agreement is made, replacement of damaged work shall be covered by an appropriate Change Order.

11.2.5 The Owner as trustee shall have power to adjust and settle any loss with the insurers unless one of the parties in interest shall object in writing within five (5) days after the occurrence of loss to the Owner's exercise of this power, and if such objection is made, the matter shall be decided by a court of competent jurisdiction or as the parties in interest otherwise mutually agree. The Owner as trustee shall, in that case, make settlement with the insurers in accordance with the orders of the court or as otherwise mutually agreed by the parties in interest.

11.2.6 If the Owner finds it necessary to occupy or use a portion or portions of the Work prior to Substantial Completion of the entire Project such occupancy or use shall not commence prior to a time mutually agreed to by the Owner and Contractor and to which the insurance company or companies providing the property insurance have consented by endorsement to the policy or policies. This insurance shall not be canceled or lapsed on account of such partial occupancy or use. Consent of the Contractor and of the insurance company or companies to such occupancy or use shall not be unreasonably withheld.

11.3 EFFECT OF SUBMISSION OF CERTIFICATES

11.3.1 The Owner and Construction Program Manager shall be under no obligation to review any Certificates of Insurance provided by the Contractor or to check or verify the Contractor's compliance with any and all requirements regarding insurance imposed by the Contract Documents. The Contractor is fully liable for the amounts and types of insurance required herein and is not excused should any policy or certificate of insurance provided by the Contractor not comply with any and all requirements regarding insurance imposed by the Contract Documents.

11.4 FAILURE OF COMPLIANCE

11.4.1 Should the Contractor fail to provide and maintain in force any and all insurance, or insurance coverage required by the Contract Documents or by law, or should a dispute arise between Owner and any insurance company of Contractor over policy coverage or limits of liability as required herein, the Owner shall be entitled to recover from the Contractor all amounts payable, as a matter of law, to Owner or any other parties, including but not limited to the Construction Program Manager and the Design Consultant, had the required insurance or insurance coverage been in force. Said recovery shall include, but is not limited to interest for the loss of use of such amounts of money, plus all attorney's fees, costs and expenses incurred in securing such determination and any other consequential damages arising out of the failure of the Contractor or insurance company to comply with the provisions of the Contract Documents, or any policy required hereby, or any other requirements regarding insurance imposed by law. Nothing herein shall limit any damages for which Contractor is responsible as a matter of law.

11.5 OWNER'S INSURANCE

11.5.1 The Owner, at his option, may purchase and maintain such insurance as will insure him against loss of use of his property due to fire or other hazards, however caused.

11.6 LICENSED INSURANCE COMPANIES

11.6.1 All insurance companies providing the above insurance shall be licensed by the **Department Insurance & Treasurer of the State of Florida** and shall be general lines of insurance. No surplus lines of insurance are permitted.

END OF ARTICLE 11

ARTICLE 12

CHANGES IN THE WORK

12.1 CHANGE ORDERS

12.1.1 The Owner may, at any time, by written order designated or indicated to be a Change Order, make any change or modification in the Work or add to the Work within the general scope of the Contract, including, but not limited to changes:

- .1 in the Specifications or Drawings;
- .2 in the sequence, method or manner of performance of the Work;
- .3 in the Owner-furnished facilities, equipment, materials, services or site; or
- .4 directing acceleration in the performance of the Work.

12.2 OWNER DIRECTED CHANGES REQUIRING AN INCREASE IN CONTRACT SUM. No change in the Contract Sum or Time may be made except by a duly authorized and executed written Change Order. If the Change in or addition to the Work will result in an increase in the Contract Sum, the Owner shall have the right to require the performance thereof on a lump sum basis, a unit price basis or a time and material basis, all as hereinafter more particularly described (the right of the Owner as aforesaid shall apply with respect to each such Change in the Work).

12.2.1 If the Owner elects to have the Change in the Work performed on a lump sum basis, its election shall be based on a lump sum proposal which shall be submitted by the Contractor to the Construction Program Manager within ten (10) days of the Contractor's receipt of a request therefor (but the Owner's request for a lump sum proposal shall not be deemed an election by the Owner to have the Change in the Work performed on a lump sum basis). The Contractor's proposal shall be itemized and segregated by labor and materials for the various components of the Change in or addition to the Work (no

aggregate labor total will be acceptable) and shall be accompanied by signed proposals of any Subcontractors who will perform any portion of the Change in, or addition to, the Work and of any persons who will furnish materials or equipment for incorporation therein. The proposal shall also include the Contractor's estimate of the time required to perform said changes or additional work.

The portion of the proposal relating to labor, whether by the Contractor's forces or the forces of any of its Subcontractors, may include reasonably anticipated gross wages of Job Site labor, including foremen, who will be directly involved in the Change in the Work (for such time as they will be so involved), plus payroll costs (including premium costs of overtime time, if overtime is anticipated, Social Security, Federal or State unemployment insurance taxes and fringe benefits required by collective bargaining agreements entered into by the Contractor or any such Subcontractor in connection with such labor) and up to ten percent (10%) of such anticipated gross wages, but not payroll costs, as overhead and profit for the Contractor or any such Subcontractor, as applicable (said overhead and profit to include all supervision except foremen).

The portion of the proposal relating to materials may include the reasonably anticipated direct costs to the Contractor or to any of its Subcontractors of materials to be purchased for incorporation in the Change in the Work, plus transportation and applicable sales and use taxes and up to ten percent (10%) of said direct material costs as overhead and profit for the Contractor or any such Subcontractor (said overhead and profit to include all small tools), and may further include the Contractor's and any of its Subcontractor's reasonably anticipated rental costs in connection with the Change in the Work (either actual or discounted local published rates), plus up to six percent (6%) thereof as overhead and profit for the Contractor or any such Subcontractors, as applicable. If any of the items included in the lump sum proposal are covered by unit prices contained in the Contract Documents, the Owner may, if it requires the Change in the Work to be performed on a lump sum basis, elect to use these unit prices in lieu of the similar items included in the lump sum proposal, in which event an appropriate deduction will be made in the lump sum amount prior to the application of any allowed overhead and profit percentages. No overhead and profit shall be applied to any unit prices.

The lump sum proposal may include up to six percent (6%) of the amount which the Contractor will pay to any of its Subcontractors for the Change in the Work as a commission to the Contractor.

- 12.2.2 In the event the Contractor fails to submit his proposal within the designated period, the Owner may order the Contractor to proceed with the Change or Addition to the Work and the Contractor shall so proceed. The Construction Program Manager shall unilaterally determine the reasonable cost and time to perform the Work in question, which determination shall be final and binding upon the Contractor.
- 12.2.3 If the Owner elects to have the Change in the Work performed on a time and material basis, the same shall be performed, whether by the Contractor's forces or the forces of any of its Subcontractors or Sub-subcontractors, at actual cost to the entity performing

the Change in the Work (without any charge for administration, clerical expense, supervision or superintendence of any nature whatsoever, including foremen, or the cost, use or rental of tools or plant), plus ten percent (10%) thereof as the total overhead and profit (except that said ten percent (10%) shall not be applied against any payroll costs, as set forth in Subparagraph 12.2.1.). The Contractor shall submit to the Owner daily time and material tickets, to include the identification number assigned to the Change in the Work, the location and description of the Change in the Work, the classification of labor employed (and names and social security numbers), the materials used, the equipment rented (not tools) and such other evidence of cost as the Owner may require. The Owner may require authentication of all time and material tickets and invoices by persons designated by the Owner for such purpose. The failure of the Contractor to secure any required authentication shall, if the Owner elects to treat it as such, constitute a waiver by the Contractor of any claim for the cost of that portion of the Change in the Work covered by a non-authenticated ticket or invoice; provided, however, that the authentication of any such ticket or invoice by the Owner shall not constitute an acknowledgement by the Owner that the items thereon were reasonably required for the Change in the Work.

12.2.4 No overhead and profit will be paid by the Owner on account of a Change in the Work except as specifically provided in this Paragraph 12.2. Overhead and profit, as allowed under this Paragraph 12.2, shall be deemed to include all costs and expenses which the Contractor or any of its Subcontractors may incur in the performance of a Change in the Work and which are not otherwise specifically recoverable by them pursuant to this Paragraph 12.2.

12.3 CONTRACTOR NOTICE OF CHANGE

12.3.1 If the Contractor asserts that any event or occurrence has caused a change in or addition to the Work which change causes an increase or decrease in the Contractor's cost or the time required for the performance of any part of the Work under the Contract, including Work not affected directly by the change, the Contractor shall, within ten (10) days of such event, give the Owner written notice as herein required. Said notice shall include the instructions or circumstances that are the basis of the claim and the Contractor's best estimate of the cost and time involved.

12.3.2 If the Contractor intends to assert a claim under this Article, he must, within ten (10) days after receipt of a written Change Order under Subparagraph 12.2 above or the furnishing of a written notice under Subparagraph 12.3.1, submit to the Construction Program Manager a written statement setting forth the specific nature and cost of such claim, unless this period is extended by the Construction Program Manager. The statement of claim hereunder may be included in the notice under Subparagraph 12.3.1 above. The statement of claim shall include all direct, indirect and impact costs associated with the change, whether incurred at the jobsite or home office, as well as the Contractor's estimate of the schedule impact of the change, if any.

12.3.3 If the parties are unable to agree to the reasonable cost and time to perform the Change, or are unable to agree as to whether a change occurred, the Construction Program Manager shall make a unilateral determination as described in Article 12.2.2. The Contractor shall proceed pursuant to the provisions of that Article.

12.4 GENERAL PROVISIONS RELATED TO CHANGES

12.4.1 The Contractor shall not be entitled to any amount for indirect costs, damages or expenses of any nature, including, but not limited to, so-called "impact" costs, labor inefficiency, wage, material or other escalations beyond the prices upon which the proposal is based and to which the parties have agreed pursuant to the provisions of Article 12, and which the Contractor, its Subcontractors or Sub-subcontractors or any other person may incur as a result of delays, interferences, suspensions, accelerations, changes in sequence or the like, for whatever cause, whether reasonable or unreasonable, foreseeable or unforeseeable, or avoidable or unavoidable, arising from the performance of any and all changes in the Work performed pursuant to this Article 12. It is understood and agreed that the Contractor's sole and exclusive remedy in such event shall be recovery of his direct costs as compensable hereunder and an extension of the Contract Time, but only in accordance with the provisions of the Contract Documents.

12.4.2 CHANGES REQUIRING A DECREASE IN CONTRACT SUM. If the Change in the Work will result in a decrease in the Contract Sum, the Owner may request a quotation by the Contractor of the amount of such decrease for use in preparing a Change Order. The Contractor's quotation shall be forwarded to the Owner within five (5) days of the Owner's request and, if acceptable to the Owner, shall be incorporated in the Change Order. If not acceptable, the parties shall make every reasonable effort to agree as to the amount of such decrease, which may be based on a lump sum properly itemized, on unit prices stated in the Contract Documents and/or on such other basis as the parties may mutually determine. If the parties are unable to so agree, the amount of such decrease shall be the total of the estimated reduction in actual cost of the Work, as determined by the Construction Program Manager in its reasonable judgment, plus ten percent (10%) thereof as overhead and profit.

12.4.3 No claim by the Contractor hereunder shall be allowed if asserted after final payment under this Contract. No claim relating to or flowing from a particular change shall be allowed after execution of the Change Order relating to that change.

12.5 ADMINISTRATIVE CHANGES IN THE WORK

12.5.1 The Design Consultant shall have authority to order administrative changes in the Work not involving an adjustment in the Contract Sum or an extension of the Contract Time and not inconsistent with the intent of the Contract Documents. Such changes shall be effected by written field order, and shall be binding on the Owner and the Contractor. The Contractor shall carry out such written field orders promptly.

12.6 DIFFERING SITE CONDITIONS

12.6.1 Should the Contractor encounter subsurface and/or latent conditions at the site materially differing from those shown on the drawings or indicated in the specifications or differing materially from those ordinarily encountered and generally recognized as inherent in work of the character provided for in this contract, he shall immediately give notice to the Construction Program Manager of such conditions before they are disturbed. The Construction Program Manager and the Design Consultant shall thereupon promptly investigate the conditions and if they find that the conditions materially differ from those shown in the Contract Documents, the Design Consultant shall prepare and process a Change Order. Any increase or decrease of cost resulting from such changes shall be adjusted in the manner provided herein for adjustments as to extra and/or additional work and changes. However, neither the Owner, Construction Program Manager nor the Design Consultant shall be liable or responsible for additional work, costs or changes to the work due to material differences between actual conditions and any geotechnical, soils and other reports, surveys and analyses made available for the Contractor's review, or as a result of known conditions at unknown quantities or locations at the site, except as required by any applicable unit prices.

END OF ARTICLE 12

ARTICLE 13

UNCOVERING AND CORRECTION OF WORK

13.1 UNCOVERING OF WORK

13.1.1 If any portion of the Work should be covered contrary to the request of the Owner or the Design Consultant or to requirements specifically expressed in the Contract Documents or to requirements of applicable Construction Permits, it must, if required in writing by the Owner, be uncovered for his observation and shall be replaced at the Contractor's expense.

13.1.2 If any other portion of the Work has been covered which the Design Consultant or the Owner has not specifically requested to observe prior to being covered, either may request to see such Work and it shall be uncovered by the Contractor. If such work be found in accordance with the Contract Documents, the cost of uncovering and replacement shall, by appropriate Change Order, be charged to the Owner. If such Work be found not in accordance with the Contract Documents, the Contractor shall pay such costs unless it be found that this condition was caused by the Owner, in which event the Owner shall be responsible for the payment of such costs. If such condition was caused by a separate contractor, Contractor may proceed against and only against, said separate contractor as provided in Article 6.

13.2 CORRECTION OF WORK

- 13.2.1 The Contractor shall promptly reconstruct, replace or correct all Work rejected by the Design Consultant as defective or as failing to conform to the Contract Documents or as not in accordance with the guarantees and warranties specified in the Contract Documents whether observed before or after Substantial or Final Completion and whether or not fabricated, installed or completed. The Contractor shall bear all costs of correcting such rejected Work, including compensation for the Design Consultant's and the Construction Program Manager's additional services made necessary thereby.
- 13.2.2 The Contractor, unless removal is waived by the Owner, shall remove from the site all portions of the Work which are defective or non-conforming, or if permitted or required, he shall correct such work in place at his own expense promptly after receipt of notice, and such rejected Work shall not thereafter be tendered for acceptance unless the former rejection or requirement for correction is disclosed.
- 13.2.3 If the Contractor does not proceed with the correction of such defective or non-conforming Work within a reasonable time fixed by written notice from the Owner, the Owner may either (1) by separate contract or otherwise replace or correct such Work and charge the Contractor the cost occasioned the Owner thereby and remove and store the materials or equipment at the expense of the Contractor, or (2) terminate this Contract for default as provided in Paragraph 14.3. If the Contractor does not pay the cost of such replacement or correction and the removal and storage within ten (10) days thereafter, the Owner may upon ten (10) additional days' written notice sell such Work at auction or at private sale and shall account for the net proceeds thereof, after deducting all the costs that should have been borne by the Contractor, including compensation for additional services of the Design Consultant, attorneys and the Construction Program Manager made necessary thereby. If such proceeds of sale do not cover all costs which the Contractor should have borne, the difference shall be charged to the Contractor and an appropriate Change Order shall be issued. If the payments then or thereafter due the Contractor are not sufficient to cover such amount, the Contractor shall pay the difference to the Owner.
- 13.2.4 The Contractor shall bear the cost of making good all work of the Owner or separate contractors destroyed or damaged by such correction or removal.
- 13.2.5 Nothing contained in Article 13.2 shall be construed to establish a period of limitation with respect to any other obligation which the Contractor might have under the Contract Documents, including Paragraph 4.6 hereof. The establishment of the time period of one year after the Date of Final Completion or such longer period of time as may be prescribed by law or by the terms of any warranty required by the Contract Documents relates only to the specific obligation of the Contractor to correct the Work which became deficient within such period of time, and has no relationship to the time within which his obligation to comply with the Contract Documents may be sought to be enforced, nor to the time within which proceedings may be commenced to establish the Contractor's liability with respect to his obligations other than specifically to correct the Work.

13.3 ACCEPTANCE OF DEFECTIVE OR NON-CONFORMING WORK

- 13.3.1 If the Owner prefers to knowingly accept defective or non-conforming Work, he may do so instead of requiring its removal and correction, in which case a Change Order must be issued to reflect a reduction in the Contract sum where appropriate and equitable, or the Owner may elect to accept payment in materials or services, in lieu of a reduction in the Contract sum. If the amount of a reduction is determined after final payment, it shall be paid to the Owner by the Contractor. The only method for the Owner to accept defective or non-conforming Work shall be by a written change order signed by the **St. Johns County School District**. Absent such a change order, no acceptance of defective or non-conforming Work is permitted.

END OF ARTICLE 13

ARTICLE 14

TERMINATION OF THE CONTRACT

14.1 TERMINATION BY THE CONTRACTOR

- 14.1.1 If the Work is stopped for a period of one hundred twenty (120) days under an order of any court or other public authority having jurisdiction, or as a result of an act of government, such as a declaration of a national emergency making materials unavailable, through no act or fault of the Contractor or a Subcontractor or their agents or employees or any other persons performing any of the Work under a contract with the Contractor, then the Contractor may, upon seven (7) additional days' written notice to the Construction Program Manager and the Design Consultant, terminate the Contract and recover from the Owner payment on a quantum merit basis, for all Work executed. The Contractor shall not be entitled to collect and hereby expressly waives and releases any claim to any profit on work not performed nor any damages related to that portion of the Contract which has been terminated.

14.2 TERMINATION FOR CONVENIENCE OF THE OWNER

- 14.2.1 The Owner may, at any time upon ten (10) days' written notice to the Contractor and to the Contractor's surety, which notice shall specify that portion of the Work to be terminated and the date said termination is to take effect, terminate (without prejudice to any right or remedy of the Owner) the whole or any portion of the work for the convenience of the Owner. The Contractor's sole remedy, in the event of such termination, will be the allowable termination costs permitted by Article 14.4. Contractor shall include termination clauses identical to Article 14 in each of his Subcontracts.

14.3 DEFAULT TERMINATION

- 14.3.1 The Owner may, upon ten (10) days' written notice to the Contractor and to the Contractor's surety, terminate (without prejudice to any right or remedy of the Owner or any subsequent buyer of any portion of the Work) the employment of the Contractor and

his right to proceed either as to the whole or any portion of the Work required by the Contract Documents and may take possession of the Work and complete the Work by contract or otherwise in any one of the following circumstances:

- .1 if the Contractor refuses or fails to prosecute the work or any separable part thereof with such diligence as will ensure the Substantial or Final Completion of the Work within the Contract Time or fails to complete the Work within said periods;
- .2 if the Contractor is in material default in carrying out any provisions of the Contract;
- .3 if the Contractor fails to supply a sufficient number of properly skilled workmen or proper equipment or materials;
- .4 if the Contractor fails to make prompt payment to Subcontractors or materialmen or for materials or labor;
- .5 if the Contractor disregards laws, permits, ordinances, rules, regulations or orders of any public authority having jurisdiction, or fails to follow the instructions of the Owner;
- .6 if the Contractor violates any provisions of the Contract Documents; or
- .7 if the Contractor refuses or fails to properly schedule, plan, coordinate and execute the Work, as specified herein, so as to perform the Work within the specified Milestone and Completion dates, or to provide scheduling or related information, revisions and updates as required by the Contract Documents.

14.3.2 The right of the Contractor to proceed shall not be so terminated under this Paragraph 14.3 because of any delays in the completion of the Work due to unforeseeable causes beyond the control and without the fault or negligence of the Contractor or his Subcontractors as specifically set forth in Paragraph 8.3 hereof.

14.3.3 If, after the Contractor has been terminated for default pursuant to Paragraph 14.3, it is determined that none of the circumstances set forth in Subparagraph 14.3.1 exist, then such termination shall be considered a termination for convenience pursuant to Paragraph 14.2. In such case, the Contractor's sole remedy will be the costs permitted by Article 14.4.

14.3.4 If the Owner terminates the employment of the Contractor, pursuant to Article 14.3, the Contractor shall not be entitled to receive any further payment until the Work is finished. If the unpaid balance of the compensation is to be paid to the Contractor hereunder shall exceed the expense of so completing the Work (including compensation for additional managerial, administrative and inspection services and any damages for delay) such excess shall be paid to the Contractor.

14.3.5 If such expenses shall exceed the unpaid balance, the Contractor and his sureties shall be liable to the Owner for such excess. If the right of the Contractor to proceed with the

Work is partially or fully terminated, the Owner may take possession of and utilize in completing the Work such materials, appliances, supplies, plant and equipment as may be on the site of the terminated portion of the Work and necessary for the completion of the Work. If the Owner does not fully terminate the right of the Contractor to proceed, the Contractor shall continue to perform the part of the work that is not terminated.

14.4 ALLOWABLE TERMINATION COSTS

14.4.1 If the Owner terminates the whole or any portion of the Work pursuant to Paragraph 14.2, then the Owner shall only be liable to the Contractor for those costs reimbursable to the Contractor in accordance with Subparagraph 14.4.2, plus a markup of ten percent for profit and overhead on the actual fully accounted costs recovered under 14.4.2; provided however, that if there is evidence that the Contractor would have sustained a loss on the entire Contract had it been completed, no profit shall be included or allowed hereunder and an appropriate adjustment shall be made reducing the amount of the allowable termination payment to reflect the indicated amount of loss. Contractor shall submit any claim of reimbursable cost, as stated in this paragraph, within 10 days of receipt of Notice of Termination or such claims are waived, released and forever barred.

14.4.2 If the Owner terminates the whole or any portion of the Work pursuant to Paragraph 14.2, the Owner shall pay the Contractor the amounts determined by the Construction Program Manager as follows:

- .1 an amount for supplies, services, or property accepted by the Owner pursuant to Clause 14.5.1.6 or sold or acquired pursuant to Clause 14.5.1.7 and not heretofore paid for, and to the extent provided in the Contract such amount shall be equivalent to the aggregate price for such supplies or services computed in accordance with the price or prices specified in the Contract, appropriately adjusted for any saving of freight or other charges; and
- .2 the total of:
 - (1) the cost incurred in the performance of the Work terminated, including initial costs and preparatory expense allocatable thereto, but exclusive of any costs attributable to supplies or services paid or to be paid for under Clauses 14.4.2.1 or 14.4.2.2.(2);
 - (2) the cost of settling and paying claims arising out of the termination of Work under Subcontracts or orders, pursuant to Clause 14.5.1.5, which are properly chargeable to the terminated portion of the Work (exclusive of amounts paid or payable on account of completed items of equipment delivered or services furnished by Subcontractors or vendors prior to the effective date of the notice of termination), which amounts shall be included in the costs payable under (1) above; and

- (3) the reasonable costs of settlement, including accounting, legal, clerical and other expenses reasonably necessary for the preparation of settlement claims and supporting data with respect to the terminated portion of the Work and for the termination and settlement of Subcontracts thereunder, together with reasonable storage, transportation and other costs incurred in connection with the protection or disposition of property allocatable to the Contract.

.3 Provided, however, that neither the Owner, the Construction Program Manager nor the Design Consultant will be liable for payments to subcontractors pursuant to Article 14.4.2.2 unless each subcontract contains termination provisions identical to those set forth in Article 14. The Owner, Construction Program Manager and the Design Consultant will not be liable to the Contractor or any of his subcontractors for any costs associated with termination if the subcontract of the party involved does not include the proper termination clauses.

14.4.3 In arriving at any amount due the Contractor pursuant to Paragraph 14.4, there shall be deducted the following:

- .1 all unliquidated advance or other payments on account theretofore made to the Contractor applicable to the terminated portion of the Contract;
- .2 any claim which the Owner may have against the Contractor;
- .3 such amount as the Construction Program Manager determines to be necessary to protect the Owner against loss because of outstanding or potential liens or claims; and
- .4 the agreed price for, or the proceeds of sale of, any materials, supplies or other things acquired by the Contractor or sold, pursuant to the provisions of Clause 14.5.1.7, and not otherwise recovered by or credited to the Owner.

14.4.4 The total sum to be paid to the Contractor under Paragraph 14.4 shall not exceed the Contract Sum as reduced by the amount of payments otherwise made or to be made for Work not terminated and as otherwise permitted by the Contract. Except for normal spoilage, and except to the extent that the Owner shall have otherwise expressly assumed the risk of loss, there shall be excluded from the amounts payable to the Contractor, as provided in Subparagraph 14.4.2, the fair value, as determined by the Construction Program Manager, of property which is destroyed, lost, stolen or damaged so as to become undeliverable to the Owner, or to a buyer pursuant to Clause 14.5.1.7.

14.4.5 If the Owner terminates the whole or any part of the Work pursuant to Paragraph 14.3, the Owner may procure, upon such terms and in such manner as the Construction Program Manager may deem appropriate, supplies or services similar to those so terminated, and the Contractor shall be liable to the Owner for any excess costs for such similar supplies or services. The Contractor shall continue the performance of the Contract to the extent not terminated hereunder.

14.5 GENERAL TERMINATION PROVISIONS

14.5.1 After receipt of a notice of termination from the Owner, pursuant to Paragraph 14.2 or 14.3, and except as otherwise directed by the Construction Program Manager, the Contractor shall:

- .1 stop Work under the Contract on the date and to the extent specified in the notice of termination;
- .2 place no further orders or subcontracts for materials, services or facilities, except as may be necessary for completion of such portion of the work under the Contract as is not terminated;
- .3 terminate all orders and subcontracts to the extent that they relate to the performance of Work terminated by the notice of termination;
- .4 at the option of the Owner and the Construction Program Manager, assign to the Owner in the manner, at the times and to the extent directed by the Construction Program Manager, all of the rights in the contracts so terminated, in which case the Owner shall have the right, at his discretion, to settle or pay any or all claims arising out of the termination of such orders and subcontracts;
- .5 settle all outstanding liabilities and all claims arising out of such termination or orders and subcontracts, with the approval or ratification of the Construction Program Manager, to the extent he may require, which approval or ratification shall be final for all the purposes of this Article;
- .6 transfer title and deliver to the entity or entities designated by the Owner, in the manner, at the times and to the extent directed by the Construction Program Manager to the extent specifically produced or specifically acquired by the Contractor for the performance of such portion of the Work as had been terminated, the following:
 - (1) the fabricated or unfabricated parts, Work in process, partially completed supplies and equipment, materials, parts, tools, dies, jigs and other fixtures, completed Work, supplies and other material produced as part of, or acquired in connection with the performance of, the Work terminated by the notice of termination; and
 - (2) the completed or partially completed plans, drawings, information, releases, manuals and other property related to the Work and which, if the Contract had been completed, would have been required to be furnished to the Owner;
- .7 use his best efforts to sell, in the manner, at the times, to the extent and at the price or prices directed or authorized by the Construction Program Manager, any property of the types referred to in Clause 14.5.1.6; provided, however, that the Contractor:

- (1) shall not be required to extend credit to any buyer, and
 - (2) may acquire any such property under the conditions prescribed by and at a price or prices approved by the Construction Program Manager; and provided further that the proceeds of any such transfer or disposition shall be applied in reduction of any payments to be made by the Owner to the Contractor under the Contract or shall otherwise be credited to the Contract Sum covered by the Contract or paid in such other manner as the Construction Program Manager may direct;
- .8 complete performance of such part of the Work as shall not have been terminated by the notice of termination; and
- .9 take such action as may be necessary, or as the Construction Program Manager may direct, for the protection and preservation of the property related to the Contract which is in the possession of the Contractor and in which the Owner has or may acquire an interest.
- 14.5.2 The Contractor shall, from the effective date of termination until the expiration of three (3) years after final settlement under the Contract, preserve and make available to the Owner, at all reasonable times at the office of the Contractor, but without direct charge to the Owner, all his books, records, documents and other evidence bearing on the costs and expenses of the Contractor under the Contract and relating to the Work terminated hereunder, or, to the extent approved by the Construction Program Manager, photographs, micro-photographs or other authentic reproductions thereof.
- 14.5.3 The Contractor shall refund to the Owner any amounts paid by the Owner to the Contractor in excess of costs reimbursable under Paragraph 14.4.
- 14.5.4 The Contractor shall be entitled to only those damages and that relief from termination by the Owner as specifically provided in Article 14.

END OF ARTICLE 14

END OF GENERAL CONDITIONS

SECTION SC

SUPPLEMENTARY CONDITIONS

GENERAL CONDITIONS

The General Conditions are further revised and supplemented by the provisions of these Supplementary Conditions. The General Conditions and the Supplementary Conditions are applicable to all of the Work under this contract and shall apply to the Contractor and all Subcontractors and Sub-subcontractors.

SUPPLEMENTS:

The following supplements modify, change, delete, or add to the General Conditions. Where any article of the General conditions is modified or any paragraph deleted, subparagraph or clause thereof is modified, or deleted by these supplements, the unaltered provisions of such article, paragraph, subparagraph or clause shall remain in effect.

Added - Section 8.3.9

The term of this contract shall be from March, 2017 to September 29, 2017 and may by mutual agreement between the District and the awarded vendor(s) be renewable for up to two (2) additional one (1) year periods. All terms and conditions of this bid, any addenda, and negotiated terms are incorporated into the contract by reference as set forth herein.

SECTION 00850

LIST OF DRAWINGS

1. GENERAL:
- 1.1 Requirements Included:
- 1.1.1 Identification of drawings.
- 1.2 Related Requirements:
- 1.2.1 Owner-Contractor Agreement: Drawings accepted by Owner for incorporation into the work.
- 1.3 Drawing Schedule:
 - **Cover Sheet**
 - **C1.0- Cunningham Creek Elementary**
 - **C2.0- Mill Creek Elementary**
 - **C3.0- Hartley Elementary**
 - **C4.0- RB Hunt Elementary**
 - **C5.0- Otis Mason Elementary**
 - **C6.0- Osceola Elementary**
 - **C7.0- Creekside High School**
 - **C8.0- Ponte Vedra High School**
 - **C9.0- Liberty Pines Academy**
 - **C10.0-Notes and Details**

END OF SECTION

SECTION 01010

SUMMARY OF WORK

1. GENERAL:

1.1. Work includes, but is not limited to, the following items:

Refer to Plan Sheets for Descriptions of Work

1.2 Contractor's Duties: The intent is to provide for the construction and completion of the work described in the contract. The Contractor shall furnish all labor, materials, equipment, tools, construction equipment, machinery, transportation, supplies, other facilities and services necessary for proper execution and completion of the work.

1.3 Work by Others: Contractor shall coordinate and schedule his work with other onsite contractors.

1.4 Contractor Use of Premises:

1.4.1 The site may be used to store materials and equipment. Do not unreasonably encumber site with materials or equipment.

1.4.2 Assume full responsibility for protection and safekeeping of products stored on premises.

1.4.3 Maintain "good housekeeping" on site.

1.4.4 Move any stored products that interfere with operations of Owner, other contractors, or adjacent property owner(s).

1.4.5 Provide adequate means of access to sites during all stages of construction.

1.5 Owner's Access to the Work:

1.5.1 The Owner reserves access to the work for observation during installation/construction of the work.

1.6 Work Schedule:

1.6.1 A time schedule shall be made to include but not be limited to:

- a. A starting of work date.
- b. A reasonable progression of work.

1. Sitework.
2. Equipment delivery date.
3. Time of installation.
4. Time of completion and Owner acceptance.

1.6.2 At the time of work completion and Owner acceptance, the Contractor shall furnish the Owner record drawings as described in this specification.

END OF SECTION

SECTION 01030

ALTERNATES

PART 1 - GENERAL

1.01 RELATED DOCUMENTS

- A. Drawings and general provisions of contract, including General and Supplementary Conditions and other Division 1 specifications sections, apply to this section.

1.02 SUMMARY

- A. This section specifies administrative and procedural requirements for alternates.
- B. Definition: An alternate is an amount proposed by bidders and stated on the Bid Form for certain construction activities defined in the Bidding Requirements that may be added or deducted from Base Bid amount if the owner decides to accept a corresponding change in either the amount of construction to be completed, or in the products, materials, equipment, systems or installation methods described in Contract Documents.
- C. Coordination: Coordinate related work and modify or adjust adjacent work as necessary to ensure that work affected by each accepted alternate is complete and fully integrated into the project.
- D. Schedule: A "Schedule of Alternates" is included at the end of this section. Specification sections referenced in the schedule contain requirements for materials and methods necessary to achieve the work described under each alternate.
 - 1. Include as part of each alternate, miscellaneous devices, accessory objects and similar items incidental to or required for a complete installation whether or not mentioned as part of the alternate.

PART 2 - PRODUCTS

Not applicable.

PART 3 - EXECUTION

Not applicable.

SCHEDULE A

Schedule of Alternates-Specifications Contained in Section 4.0

Alternate #1: Mill Creek Elementary: This item includes the construction of an additional asphalt “drop-off” lane at Mill Creek Elementary. See Sheet C2.0 for detailed scope of work.

END OF SECTION

SECTION 01300

SUBMITTALS

1. GENERAL:

1.1 Submittal Procedures:

1.1.1 Identify Project, Contractor, Subcontractor or supplier; pertinent drawing sheet and detail number(s), and specification section number, as appropriate.

1.1.2 Apply Contractor's stamp, signed or initialed certifying that review, verification of products required, field dimensions, adjacent contraction work, and coordination of information, is in accordance with the requirements of the work and Contract Documents.

1.1.3 Schedule submittals to expedite the project, and deliver to Engineer at business address. Coordinate submission of related items.

1.1.4 Identify variations from Contract Documents and Product or system limitations which may be detrimental to successful performance of the completed work.

1.1.5 Provide space for Contractor and Engineer review stamp.

1.1.6 Revise and resubmit submittals as required, identify all changes made since previous submittal.

1.1.7 Distribute copies of reviewed submittals to concerned parties. Instruct parties to promptly report any inability to comply with provisions.

1.2 Construction Progress Schedules:

1.2.1 Submit initial progress schedule in duplicate within 10 days after date of Owner-Contractor Agreement for Engineer review.

1.2.2 Revise and resubmit as required.

1.2.3 Submit revised schedules with each Application for Payment, identifying changes since previous version.

1.2.4 Submit a horizontal bar chart with separate line for each major section of work or operation identifying first work day of each week.

1.2.5 Show complete sequence of construction by activity, identifying work of separate stages

and other logically grouped activities. Indicate the early and late start, early and late finish, float dates, and duration.

1.2.6 Indicate estimated percentage of completion for each item of work at each submission.

1.2.7 Indicate submittal dates required for shop drawings, product data, samples, and product delivery dates, including those furnished by Owner and under Allowances.

1.3 Proposed Products List:

1.3.1 Within 10 days after Owner-Contractor Agreement, submit complete list of major products proposed for use, with name of manufacturer, trade name and model number of each product.

1.3.2 For products specified only by reference standards, give manufacturer, trade name, model or catalog designation, and reference standards.

1.4 Shop Drawings:

1.4.1 Submit the number of opaque reproductions which Contractor requires, plus three copies which will be retained by Engineer.

1.5 Product Data:

1.5.1 Submit the number of copies which the Contractor requires, plus three copies which will be retained by the Engineer.

1.5.2 Mark each copy to identify applicable products, models, options, and other data. Supplement manufacturers' standard data to provide information unique to this project.

1.6 Manufacturer's Instructions:

1.6.1 When specified in individual specification sections, submit manufacturers' printed instructions for delivery, storage, assembly, installation, start-up, adjusting, and finishing, in quantities specified for Product Data.

1.6.2 Identify conflicts between manufacturers' instructions and Contract Documents.

1.7 Manufacturer's Certificates:

1.7.1 When specified in individual specification sections, submit manufacturers' certificate to Engineer for review, in quantities specified for Product Data.

1.7.2 Indicate material or product conforms to or exceeds specified requirements. Submit supporting reference date, affidavits, and certifications as appropriate.

1.7.3 Certificates may be recent or previous test results on material or product, but must be acceptable to Engineer.

2. PRODUCTS:

2.1 Not Used.

3. EXECUTION:

3.1 Not Used.

END OF SECTION

SECTION 01311

CONSTRUCTION SCHEDULES AND REPORTS

A. GENERAL REQUIREMENTS AND SCOPE

1. The following additional scheduling requirements are a part of this Contract.
2. Work under this Section shall consist of furnishing a Construction Schedule showing in detail how the Contractor plans to execute and coordinate the Work. The Contract Schedule shall be based on and incorporate the Contract Milestone and Completion Dates specified in the Owner-Contractor Agreement and shall show the order in which Contractor shall perform the Work, projected dates for the start and completion of separable portions of the work, and any other information concerning Contractor's Work scheduling as Owner may request. The proposed Construction Schedule and related Schedule of Values must be submitted to the Design Consultant, Construction Program Manager and Owner prior to mobilization of the site.
3. The Construction Schedule shall be in the form of a bar chart and shall consist of horizontal lines, or bars, plotted along a daily time scale. Each pay item designed in the Contractor's Schedule of Values shall be denominated as a separate activity and represented by a horizontal bar or bars on the chart. The time-scale shall indicate all required Milestone and Completion Dates as set forth in the Owner-Contractor Agreement. The horizontal bar(s) shall indicate the start and finish dates as well as the total time period of performance for each pay item activity. The Contractor shall arrange the chart so as to show the pay item activities when are necessary to fulfill each and every Milestone and Completion Date requirement. This Schedule must be submitted by Contractor prior to commencement of work and award of contract.
4. Each Work item on the bar chart, as well as being correlated to the payment document, shall be broken into reasonable work segments/activities (where practicable) with individual starting and stopping dates. As a minimum, work shall be segmented to demonstrate its relationship to the various Milestone Dates, if any. The segmented Work activities shall be cost loaded to show their dollar value as part of the entire pay item. Activity titles shall be self-explanatory; abbreviations shall be shown in the legend.
5. If the Contractor should desire or intend to complete the work earlier than any required Milestone or Completion date, the Owner or the Construction Program Manager shall not be liable to the Contractor for any costs or other damages should the contractor be unable to complete the Work before such Milestone or Completion date. The duties, obligations and warranties of the Owner to the Contractor shall be

consistent with and applicable only to the completion of the Work on the Milestone and completion dates required in the Owner-Contractor Agreement, unless Owner, the Construction Program Manager and Contractor otherwise agree in a written Change Order.

B. UPDATES AND REVISIONS

1. The chart shall be updated to show actual progress and the effect of modifications, delays and other events. A second bar for each work item, in a contrasting color or pattern, shall be drawn parallel to the proposed schedule to show actual progress and to forecast future progress. The actual start and stop dates shall be entered, as well as the actual dates of the Milestone events. Updates are to be submitted monthly to the Construction Program Manager with, and as part of, each payment request.
2. The updated Construction Schedule submitted by Contractor shall not show a completion date later than the Contract Time, subject to any time extensions approved by Owner; provided, however, that if Contractor believes he is entitled to an extension of the Contract under the Contract Documents, Contractor shall submit to the Construction Program Manager, with each update, a separate schedule analysis (entitled "Requested Time Adjustment Schedule") indicating suggested adjustments in the Contract Time which should, in the opinion of the Contractor, be made by time extension, due to changes, delays or conditions occurring during the past month or previously, or which are expected or contemplated by Contractor (whether such conditions are excusable under the Contract or are allegedly due to Contractor or Owner fault); this separate schedule, if submitted, shall be accompanied or preceded by a formal time extension request as required by the Contract Documents and a detailed narrative justifying the time extension requested. To the extent any time extension requests are pending at the time of any update in the Construction Schedule, the "Requested Time Adjustment Schedule" shall be updated also each month, to reflect any adjustments made by Contractor in the Construction Schedule, or any time extensions previously granted by Owner, and to reflect actual or expected progress. Neither the Construction Program Manager nor the Owner shall have any obligation to consider any time extension request unless the requirements of the Contract Documents, and specifically, but not limited to, the requirements set forth in this paragraph, are complied with; and neither the Construction Program Manager nor the Owner shall not be responsible or liable to Contractor for any constructive acceleration due to failure of Owner to grant time extensions under the Contract Documents should Contractor fail to substantially comply with the submission requirements and the justification requirements of this Contractor for time extension requests. Contractor's failure to perform in accordance with the Construction Schedule shall not be excused, nor be chargeable to Owner, the Construction Program Manager nor the Design Consultant, because Contractor has submitted time extension requests or the "Requested Time

Adjustment Schedule."

3. Neither the updating of Contractor's work schedule nor the submission, updating, change or revision of any other report or schedule submitted to Owner by Contractor under this Contract nor review or non-objection of the Owner or Construction Program Manager of any such report or schedule shall have the effect of amending or modifying, in any way, the Contract Completion Date, Milestone Dates or of modifying or limiting in any way Contractor's obligations under this Contract.
4. All of Contractor's detailed calculations and documents supporting all schedules, reports, and forecasts shall be available to Owner and the Construction Program Manager on request.
5. Each updated Construction Schedule submitted by contractor to the Construction Program Manager shall be accompanied by a narrative report which reflects the following:
 - a. Description of Work accomplished since submission of previous progress schedule;
 - b. Comparison of the actual status of the Work with Contractor's project schedule;
 - c. Status of equipment and material deliveries;
 - d. Personnel staffing schedule;
 - e. Causes of any delays;
 - f. Revision of schedules; and
 - g. Action proposed to restore schedule.
6. Should conditions exist such that certain activities shown on the Contractor's Construction Schedule fall behind schedule to the extent that any of the mandatory specific or milestone dates or completion dates are in jeopardy, the Contractor shall be required to, at no extra cost to the Owner, prepare and submit to the Construction Program Manager a supplementary Recovery Schedule, in a form and detail appropriate to the need, to explain and display how he intends to reschedule those activities to regain compliance with the Construction Schedule during the immediate subsequent pay period.

C. SCHEDULE OF OFF-SITE ACTIVITIES

1. The contractor shall include in his Construction Schedule all procurements related activities which lead to the delivery of materials to the site in a timely manner. Upon written approval by the Owner, these activities may be submitted as a separate Off-Site Activities Schedule, properly correlated to the Construction Schedule. The schedule of off-site activities shall include, but is not limited to, the following:
 - a. Dates for submittals, ordering, manufacturing, or fabricating and delivery of equipment and materials. Long lead items requiring more than one month between ordering and delivery to site shall be clearly noted;
 - b. All significant activities to be performed by the Contractor during the fabrication and erection/ installation in a Contractor's plant or on a job site, including materials/equipment purchasing, delivery; and
 - c. Contractor's drawings and submittals to be prepared and submitted through the Construction Program Manager to the Owner or Design Consultant for approval.
2. The Contractor shall be solely responsible for expediting the delivery of all materials to be furnished by him so that the construction progress shall be maintained according to the current schedule for the Work as approved by the Construction Program Manager.
3. The Construction Program Manager shall be advised in writing by the Contractor wherever it is anticipated or determined by the Contractor that the delivery date of any material and/or equipment furnished by the Contractor for installation will be later than the delivery dates shown on the schedule, subject to schedule updates.
4. Submittals, equipment orders and similar items are to be treated as schedule activities.

D. FLOAT TIME

1. Float or slack time is defined as the amount of time between the earliest start date and the latest start date or between the earliest finish date and the latest finish date of an activity on the Construction. Float or slack time is for the exclusive use and benefit of the Owner. The Contractor acknowledges and agrees that actual delays, affecting activities containing float time, will not have any affect upon contract completion times, providing that the actual delay does not exceed the float time associated with those activities.
2. Extensions of time for performance as described in the Contract Documents will be

granted only to the extent that time adjustment for the activity or activities affected by any condition or event which entitles the Contractor to a time extension exceed the total float or slack of the affected activity at the time of issuance of a Change Order or the commencement of any delay or condition for which an adjustment is warranted under the Contract Documents.

E. COORDINATION

1. The Contractor shall coordinate his work with that of other contractors and shall cooperate fully with the Construction Program Manager in maintaining orderly progress toward completion of the work as scheduled. The Construction Program Manager's decisions regarding priority between the Contractor's work and the work of other contractors at the site shall be final and shall not be cause for extra compensation or extension of time, except where extension of time is granted because of a delay for which Contractor is otherwise entitled to an extension of time under the Contract Documents.
2. The milestone dates referred to in the Contract Documents for delivery of Owner-furnished equipment and materials and interface activities of other contractors on the site are based on dates set forth in separate contracts with the Owner and represent the information available at this time.
3. Failure of Owner-furnished equipment and materials to arrive as scheduled, or failure of other construction contractors to meet their schedule, shall not be justification for an extension of time, except where such failure causes, in the opinion of the Construction Program Manager and Design Consultant, an unreasonable delay in the Contractor's work, in which case the provisions of the General Conditions regarding extensions of time and extra work shall apply.
4. The Contractor shall keep himself, and his subcontractors, advised at all times during the course of the Work regarding delivery status of Owner-furnished equipment and materials and of the progress of construction work being performed under separate contracts.

F. CONTRACTOR COVENANTS AND GUARANTEES

1. Contractor covenants and guarantees that Contractor will not:
 - a. Misrepresent to Owner, Design Consultant or Construction Program Manager its planning scheduling or execution of the Work;
 - b. Utilize schedules materially different from those provided by Contractor to the Owner or Construction Program Manager.

- c. Prepare schedules, updates, revisions or reports for the work which do not accurately reflect the actual intent or reasonable and actual expectations of Contractor and its Subcontractors as to:
 - (1) The sequences of activities,
 - (2) The duration of activities,
 - (3) The responsibility of activities,
 - (4) Resources availability,
 - (5) Labor availability or efficiency,
 - (6) Foreseeable weather conditions,
 - (7) The value associated with the activity,
 - (8) The percentage complete of any activity,
 - (9) Completion of any item of work or activity,
 - (10) Project milestone completion,
 - (11) Delays, slippages, or problems encountered or expected,
 - (12) Subcontractor requests for time extensions or delay claims of subcontractors, and
 - (13) If applicable, the float time available.
2. Contractor's failure to substantially comply with the foregoing covenant and guarantee shall be a substantial and material breach of contract which will permit Owner to terminate Contract for default, or withhold payments under the Contract Documents, and shall entitle Owner to the damages afforded for misrepresentation or fraud by these Contract documents or applicable law.
3. Should Contractor fail to substantially comply with the provisions of the Contract documents relating to planning, scheduling and execution of the Work by the overall project schedule, Owner and the Construction Program Manager shall have the right, at their option, to retain the services of scheduling consultants or experts (including attorneys if necessary in their opinion) to prepare a schedule in

accordance with the Contract Documents and to review and analyze same, in order to allow Owner and Construction Program Manager to evaluate the program of the Work by Contractor, to determine whether Contractor is substantially complying with the contract Documents, and to direct such action on the part of the contractor, as permitted by the Contract Documents, as required to ensure, under the owner's schedule prepared hereunder, that Contractor will comply with such schedule. All costs (including attorneys' fees) incurred by Owner or Construction Program Manager in preparing the schedule hereunder shall be charged to Contractor's account or deducted from retainage. If contractor fails to substantially comply with the scheduling and execution of the work requirements of the Contract Documents, Contractor hereby agrees, in such instance, to comply with such schedules, as the Construction Program Manager develops, or directions, and activity sequences and durations as the Construction Program Manager may reasonably require, without additional cost to the Owner (subject only to cost adjustments for such changes in the Work as the Owner may direct by written change order), to ensure completion within the Contract Time.

G. DEFAULT

Failure of the Contractor to substantially comply with the requirements of this Section shall constitute reason that the Contractor is failing to prosecute the Work with such diligence as will insure its completion within the Contract times and shall be considered grounds for termination by the Owner, pursuant to subparagraph 14.3.1.1 of the General Conditions.

END OF SECTION

SECTION 01400
QUALITY CONTROL

1. GENERAL:

1.1 Section includes:

1.1.1 Quality assurance and control of installation.

1.1.2 References.

1.1.3 Inspection and testing laboratory services.

1.2 Related Sections:

1.2.1 Section 01300 - Submittals: Submission of Manufacturers' Instructions and Certificates.

1.3 Quality Assurance/Control of Installation:

1.3.1 Monitor quality control over suppliers, manufacturers, products, services, site conditions, and workmanship, to produce work of specified quality.

1.3.2 Comply fully with manufacturers' instructions, including each step in sequence.

1.3.3 Comply with specified standards as minimum quality for the work except when more stringent tolerances, codes, or specified requirements indicate higher standards or more precise workmanship.

1.3.4 Perform work by persons qualified to produce workmanship of specified quality.

1.3.5 Secure products in place with positive anchorage devices designed and sized to withstand stresses, vibration, physical distortion or disfigurement.

1.4 References:

1.4.1 Conform to reference standard by date of issue current on date on Contract Documents.

1.4.2 Obtain copies of standards when required by Contract Documents.

1.4.3 Should specified reference standards conflict with Contract Documents, request clarification from Engineer before proceeding.

1.4.4 The contractual relationship of the parties to the Contract shall not be altered from the Contract Documents by mention or inference otherwise in any reference document.

1.5 Inspection and Testing Laboratory Services:

1.5.1 Owner will employ services of an independent firm to perform inspection and testing.

1.5.2 The independent firm will perform inspections, tests, and other services specified in individual specification sections and as required by the Engineer.

1.5.3 Reports will be submitted by the independent firm to the Engineer, in duplicate, indicating observations and results of tests and indicating compliance or non-compliance with Contract Documents.

1.5.4 Cooperate with independent firm: furnish samples of materials, design mix, equipment, tools, storage and assistance as requested.

a. Notify Engineer and independent firm 24 hours prior to expected time for operations requiring services.

1.5.5 Retesting required because of non-conformance to specified requirements shall be performed by the same independent firm or instruction by the Engineer. Cost for retesting will be absorbed by Contractor.

2. PRODUCTS:

2.1 Not Used.

3. EXECUTION:

3.1 Not Used.

END OF SECTION

SECTION 01600

MATERIAL AND EQUIPMENT

1. GENERAL:

1.1 Section includes:

- a. Products.
- b. Transportation and handling.
- c. Storage and protection.
- d. Product options.
- e. Substitutions.

1.2 Related Sections: Section 01400 - Quality Control: Product quality monitoring.

1.3 Products:

1.3.1 Products: Means new material, machinery, components, equipment, fixtures, and systems forming the work. Does not include machinery and equipment used for preparation, fabrication, conveying and erection of the work. Products may also include existing materials or components required for reuse.

1.3.2 Do not use materials and equipment removed from existing premises, except as specifically permitted by the Contract Documents.

1.3.3 Provide interchangeable components of the same manufacturer, for similar components.

1.4 Transportation and Handling:

1.4.1 Transport and handle products in accordance with manufacturer's instructions.

1.4.2 Promptly inspect shipments to assure that products comply with requirements, quantities are correct, and products are undamaged.

1.4.3 Provide equipment and personnel to handle products by methods to prevent soiling or damage.

1.5 Storage and Protection:

1.5.1 Store and protect products in accordance with manufacturer's instructions, with seals and labels intact and legible. Store sensitive products in weather-tight, climate controlled enclosures.

1.5.2 For exterior storage of fabricated products, place on sloped supports, above ground.

1.5.3 Cover products subject to deterioration with impervious sheet covering. Provide ventilation to avoid condensation.

1.5.4 Store loose granular materials on solid flat surfaces in a well-drained area. Prohibit mixing with foreign matter.

1.5.5 Provide equipment and personnel to store products by methods to prevent soiling or damage.

1.5.6 Arrange storage of products to permit access for inspection. Periodically inspect to assure products are undamaged and are maintained under specified conditions.

1.6 Product Options:

1.6.1 Products Specified by Naming One or More Manufacturers with a Provision for Substitutions: Submit a request for substitution for any manufacturer not named.

1.7 Substitutions:

1.7.1 Engineer will consider requests for substitutions only within 15 days after date of Owner-Contractor Agreement.

1.7.2 Substitutions may be considered when a product becomes unavailable through no fault of the Contractor.

1.7.3 Document each request with complete data substantiating compliance of proposed substitution with Contract Documents.

1.7.4 A request constitutes a representation that the Contractor:

 a. Has investigated proposed product and determined that it meets or exceeds the quality level of the specified product.

 b. Will provide the same warranty for the substitution as for the specified product.

 c. Will coordinate installation and make changes to other work which may be required for the work to be complete with no additional cost to Owner.

d. Waives claims for additional costs or time extension which may subsequently become apparent.

1.7.5 Substitutions will not be considered when they are indicated or implied on shop drawings or product data submittals, without separate written request, or when acceptance will require revision to the Contract Documents.

1.7.6 Substitution Submittal Procedure:

a. Submit three copies of request for substitution for consideration. Limit each request to one proposed substitution.

b. Submit shop drawings, product data, and certified test results attesting to the proposed product equivalence.

c. The Engineer will notify Contractor, in writing, of decision to accept or reject request.

2. PRODUCTS:

2.1 Not Used.

3. EXECUTION:

3.1 Not Used.

END OF SECTION

SECTION 01700
CONTRACT CLOSEOUT

1. GENERAL:

1.1 Work Included:

1.1.1 This section includes the requirements and administrative procedures for closing out the work.

1.2 Related Work:

1.2.1 General Conditions and Conditions of the Contract.

2. PRODUCTS:

2.1 Not Used.

3. EXECUTION:

3.1 Final Inspection:

3.1.1 Contractor shall submit written certification to the Engineer that work is completed and ready for final inspection.

3.1.2 Engineer will make inspection with reasonable promptness. If work is incomplete or defective, Engineer shall notify Contractor to remedy deficiencies.

3.1.3 Upon notification of completion, Engineer will reinspect work and, when acceptable, issue Certification of Substantial Completion.

3.2 Final Cleaning:

3.2.1 Execute prior to final inspection.

3.2.2 Clean site; rake grass areas and clean other surfaces used during construction operation. Plant sod of same species of surrounding grass in all areas damaged during construction.

3.2.3 Remove waste and surplus materials, rubbish, and construction facilities from the project and from the site.

3.3 Closeout Submittals:

3.3.1 When the Engineer has determined that the work is acceptable under the contract documents and the contract fully performed, the Contractor shall prepare and submit his final Application for Payment to the Engineer together with the following:

- a. Contractor's Affidavit of Payment of Debts and Claims.
- b. Contractor's Affidavit of Release of Liens.
- c. Contractor's lien waiver in the full amount of the Contract Sum.
- d. Lien waivers from all subcontractors and major material suppliers who have furnished material for the work under contract with the Contractor or a subcontractor. The lien waivers shall be in the full amount of the contract involved.
- e. Consent of surety to final payment.
- f. Evidence of compliance with requirements of governing authorities.
 1. Certificates of Inspection from all required agencies and departments.
 2. Certificate of Occupancy.
- g. Project Record Documents.
- h. Operating and Maintenance Data, Instructions to Owner's Personnel.
- i. Warranties and Bonds.
- j. Contractor shall provide Owner with a complete set of surveyed "As-Built" drawings showing all paving, drainage, and electrical work within this Contract.

END OF SECTION

CONTRACT SPECIFICATIONS

ST. JOHNS COUNTY SCHOOL DISTRICT BID NO. 2017-03 PAVEMENT REHABILITATION

PART 1 - GENERAL

1.1 DESCRIPTION

- A. Work under this section includes the furnishing of all labor, material and equipment required to provide rehabilitation of pavement, driveways, and drainage improvements as required for the work as specified hereinafter.
- B. Where construction requires removing pavement or where existing paving is damaged by the Contractor's operation, it is the intent of these specifications that due care be exercised in cutting pavement, backfilling trenches, and replacing pavement so that where no further settlement of trenches will occur and the paved surfaces will be restored to a condition equal to that existing before construction began.
- C. Except as otherwise provided herein, materials and methods of operations required to install new and replacement pavement shall be in accordance with the applicable requirements of the Florida Department of Transportation, Standard Specifications for Road & Bridge Construction, Current Edition.
- D. No paving work shall be accomplished until all heavy construction equipment is permanently removed from the site.

1.2 SUBMITTALS

- A. The Contractor shall submit asphalt mix certifications.
- B. Contractor shall submit test results of density and thickness of each 5,000 square feet of surface, in accordance with FDOT Specification Section 330-15. Test results shall be forwarded to the Engineer.

1.3 STANDARD OF WORK

- A. The Contractor shall be responsible for controlling the widths of rehabilitation. Unauthorized removal of pavement, curbs, etc., will not be included for payment under the Contract but shall be replaced in accordance with these specifications at no expense to the Owner.

PART 2 - MATERIALS/PRODUCTS

2.1 PAVEMENT SUBGRADES

- A. Stabilization: Subbase stabilization is required for full depth repair/replacement of pavement sections, and shall extend to a depth of twelve (12) inches below the bottom of the base. All stabilized areas shall have a minimum limerock bearing ratio (LBR) of 40. All materials, equipment and workmanship shall be in accordance with Section 160 of the Florida Department of Transportation Standard Specifications for Road & Bridge Construction, Current Edition, except that paragraphs 160-9 and 160-10 shall be omitted. Type B stabilization, as specified in paragraphs 160-6 of the DOT Specifications, shall be used.

- B. Base Course: The base course for paved areas shall be verified in areas of full depth repair/pavement replacement and shall be limerock constructed to a thickness of six inches (6"). All materials, equipment and workmanship shall be in accordance with the Section 200 of the Florida Department of Transportation, Standard Specifications, Current Edition, except that paragraphs 200-11 and 200-12 shall be omitted.

- C. Base Course (Heavy Duty)(Alternate #1): The base course shall be limerock constructed to a thickness of eight inches (8"). All materials, equipment and workmanship shall be in accordance with the Section 200 of the Florida Department of Transportation, Standard Specifications, Current Edition, except that paragraphs 200-11 and 200-12 shall be omitted.

2.2 ASPHALT PAVEMENT

- A. Provide asphalt pavement where indicated on the drawings, or where new work has required removal of existing asphalt pavement.

- B. Prime Coat: A prime coat consisting of a bituminous material hereinafter specified shall be applied at the rate of fifteen hundredths (0.15) gallons per square yard to the previously prepared base course. All materials, equipment and workmanship shall be in accordance with Section 300 of the Florida Department of Transportation Standard Specifications, Current Edition, except that paragraphs 300-8 and 300-9 shall be omitted.

- C. Asphaltic Concrete Surface Course: The paving shall have a wearing surface of Type S-III Asphaltic Concrete with a thickness of one and one-half (1-1/2) inch or equal to the thickness of the existing surface course, whichever is greater. All equipment, materials, workmanship and methods employed in construction of the wearing surface shall be accordance with Section 320, 330, 331, and 332 of the aforementioned Florida Department of Transportation Standard

Specifications, Current Edition, except that paragraphs 331-6,331-7, 332-5 and 332-6 shall be omitted.

- D. Asphaltic Concrete (Heavy Duty)(Alternate #1): The paving shall have a wearing surface of Type S-I Asphaltic Concrete with a thickness of two (2) inches. All equipment, materials, workmanship and methods employed in construction shall be in accordance with Section 320, 330, 331, and 332 of the aforementioned Florida Department of Transportation Standard Specifications, Current Edition, except that paragraphs 331-6,331-7, 332-5 and 332-6 shall be omitted.
- E. Tack Coat: Materials and application of the tack coat shall be in accordance Section 300 of the Florida Department for Road & Bridge Construction, Current Edition.

2.3 CONCRETE PAVEMENT

- A. Concrete Pavement: Provide replacement concrete pavement in roadways where shown on the drawings and as required where new work necessitates cutting existing concrete pavement. Concrete pavement shall conform to the requirements of Section 350 of the Florida Department of Transportation Standard Specifications, Current Edition, with specific applicability of the requirements of paragraph 350-3.11 for paving of small or narrow areas, except that paragraphs 350-19 and 350-20 shall be omitted.
- B. Concrete shall be 4,000 PSI concrete, Portland Cement Concrete, with the exception that 3,000 PSI high-early-strength concrete shall be used for state and federal highways.

2.4 CURB AND GUTTER REPLACEMENT

- A. Replacement curbs or curb & gutter shall be constructed of cast-in-place 3,000 PSI concrete, Portland Cement Concrete and shall conform to the existing type of construction unless directed otherwise. If the limits of the area to be repaired fall within thirty (30) inches of the nearest joint, replacement shall be made to such joint.

2.5 ASPHALTIC CONCRETE OVERLAY

- A. General: The work specified in this section consists of the application of an asphaltic concrete overlay composed of bituminous material applied in a single application. This section includes the furnishing of all labor, materials and equipment required to provide an overlay of the pavement as required for the work as specified hereinafter.

- B. Tack Coat: Materials and application of the tack coat shall be in accordance with Section 300 of the Florida Department of Transportation Standard Specifications for Road and Bridge Construction, Current Edition, except that paragraphs 300-8 and 300-9 shall be omitted.
- C. Asphalt Concrete Overlay: Asphaltic concrete overlay shall be Type S-III and in accordance with the requirements of Section 300 of the Florida Department of Transportation Standard Specifications for Road and Bridge Construction, Current Edition, and shall be applied to a thickness of 1-1/2 inches and in accordance with the requirements of the paragraph described in Section 331.

2.6 SEALER- See attached manufacturer specifications at the end of contract specifications.

2.7 POURABLE CRACK FILLER

- A. Description: The pourable crack filler shall be a rubberized asphalt emulsion crack filler formulated to be flexible and fast setting. The pourable crack filler shall be suitable for all asphaltic concrete and Portland cement concrete pavements.
- B. Technical Data: The pourable crack filler shall be a non-hazardous material when tested according to FPA's T.C.L.P. It shall be a water based material containing less than 108/L (.08 lbs. gal.) VOC content.

It shall meet the following requirements when tested according to ASTM D2939 and D244 procedures:

	<u>Max</u>	<u>Min</u>
Non-volatile %	--	68
Water %	32	--
Specific gravity	--	1.2

2.8 CRUSHED CONCRETE (Crushcrete)

- A. Provide crushed concrete where indicated on the drawings.
- B. The crushed concrete material is to be placed to a minimum depth of four inches (4") after compaction with compaction finished to 100% maximum density. The existing base material shall be compacted to 95% maximum density to a depth of twelve inches (12"). The placement of the crushed concrete shall match the existing crushed concrete areas.

- C. The crushed concrete shall conform to AASHTO T-180 specifications. The gradation of the coarse aggregate shall be as follows:

<u>Sieve Size</u>	<u>Specification Requirements</u>
2"	100
1 1/2"	95-100
3/4"	65-90
3/8"	45-75
4	35-60
10	25-45
50	5-25
200	0-10

PART 3 - EXECUTION

3.1 GENERAL

- A. Contractor to maintain line and grade to provide positive drainage from all full depth replacement and overlay areas.

3.2 ORDER OF WORK

- A. Work shall be accomplished in the following order unless otherwise specified:
 - 1. Stabilizing and compacting of subbase, when required.
 - 2. Limerock base course.
 - 3. Prime coat.
 - 4. Asphaltic concrete surface course.
 - 5. Crack filling where required.
 - 6. Asphaltic concrete overlay where required.
 - 7. Seal coating where required.
 - 8. Concrete pavement.

3.3 ASPHALTIC CONCRETE OVERLAY

- A. Thoroughly clean the pavement surface of all dirt, debris, and vegetation using brooms, air blowers, and/or other power sweepers. Soil sterilant shall be applied, as required.
- B. Apply tack coat to the areas to be resurfaced. Also apply a tack coat to contact surfaces of curbs, manholes, and other structures.
- C. Apply FDOT approved, 1-1/2 inch minimum bituminous surface course in accordance with the attached specifications and drawings. Feather edge to meet existing grade at limits shown on the drawings. Performance shall be in accordance with Florida Department of Transportation Standard Specifications for Road and Bridge Construction, Current Edition.

3.4 REMOVAL OF PAVEMENT, WALKS & DRIVEWAY

- A. Bituminous pavement shall be removed to clean continuous straight lines by sawcutting. Where bituminous pavement adjoins a trench, the edges adjacent to the trench shall be trimmed to neat straight lines before pavement repair to insure that all areas to be repaired are accessible to rollers used to compact the subgrade or paving materials.
- B. Concrete pavement shall be removed to neatly sawed edges. Sawcuts shall be made to a minimum depth of one and one-half (1-1/2) inches. If a sawcut in concrete pavement falls within three (3) feet (10 feet for state & federal highways) of a construction joint, expansion joint or edge, the concrete shall be removed to the joint or edge. The edges of existing concrete pavement adjacent to trenches, where damaged subsequent to sawcutting or the pavement, shall again be sawcut to neat straight lines for the purpose of

removing the damaged pavement areas. Such sawcuts shall be parallel to the original sawcuts or shall be cut on an angle which departs from the original sawcut not more than one (1) inch in each six (6) inches.

- C. Concrete curb, walkways, gutters and driveways shall be removed to neatly sawed edges with sawcuts to a minimum depth of one and one-half (1-1/2) inches. Concrete sidewalk or driveway to be removed shall be neatly sawed in straight lines parallel to the curb or at right angles to the alignment of the sidewalk. No section to be replaced shall be smaller than thirty (30) inches in either length or width. If sawcut in walkway or driveway would fall within 30 inches of a construction joint, expansion joint, or edge, the concrete shall be removed to the joint or edge except where the sawcut would fall with twelve (12) inches of a score mark, the sawcut shall be made in an along the score mark. Where a paved concrete driveway return apron is cut, the complete return apron shall be replaced from the street roadway back to the approved cut furthest from the roadway beyond the tangent point of the return radius. The finished return radius shall be at least as large as that on the original driveway apron. Curb and gutter shall be sawed to a depth of one and one-half (1-1/2) inches on a neat line at right angles to the curb face.

3.5 CONCRETE PLACEMENT

- A. Contraction, expansion and construction joints shall be formed and installed in conformance with Florida Department of Transportation Standard Specifications for Road and Bridge Construction, Current Edition, Section 350.12.
- B. Newly placed concrete pavement sections shall be properly barricaded and lighted by the Contractor to exclude traffic during the curing period.

3.6 CURB AND GUTTER

- A. Existing curbs and curb and gutter sections shall be cut out as necessary to permit construction of the work as authorized by the Engineer.

- B. Where Florida Department of Transportation Standard Curb & Gutter has been removed, such shall be replaced with similar construction in accordance with Florida Department of Transportation Standard Specifications, Current Edition.
- C. All curb and gutters outside the limit of construction which are willfully or negligently destroyed, broken or otherwise defaced shall be removed, disposed of and replaced in accordance with these specifications at no additional cost to the owner.

3.7 REPAIR OF WALKWAYS & DRIVEWAYS

- A. Where damaged or required to be cut by the Contractor's operations, walkways and driveways shall be repaired to conform to the existing type construction. Walkways and driveways other than concrete shall be restored by approved methods and materials, equal to or better than original condition.
- B. For the restoration of concrete walkways and driveways, the existing adjacent shall be cut back with a masonry saw or removed to the nearest dummy expansion joint, to remove undermined concrete and provide square edges.
- C. The area over which the concrete is to be placed shall be filled to the proper grading and width. The bed shall be thoroughly compacted by approved mechanical compaction equipment to 100 percent of maximum density as determined by the Laboratory Standard Compaction Test (ASTM Designation D698-70). In all cases where fill is required to bring the subgrade to the required elevation, the filling shall be made in layers not to exceed six (6) inches in depth before tamping and each layer shall be thoroughly compacted. Filling shall be at \pm two (2) percent of optimum moisture content at the time of compaction. A tolerance of minus two (2) percent (-2%) will be allowed in the compaction effort.
- D. An approved type of expansion joint shall be inserted across walkways at intervals not exceeding eighteen (18) feet with dummy groove joints at six (6) foot intervals. Where walkways and driveways must be replaced where they intersect, expansion joints shall be provided on all four (4) sides of the repair.

- E. The thickness of concrete walkways and driveways shall be equal to or greater than existing, but not less than four (4) inches for walkways and five (5) inches for driveways. Concrete walkways and driveways shall be monolithic construction and shall be 3,000 PSI concrete.
- F. When the subgrade has been prepared it shall be moistened sufficiently to prevent rapid leaching of water from the concrete and the concrete spread on the moist subgrade for the full width and depth. It shall be brought to the required grade by means of an approved template and thoroughly compacted and finished by floating and troweling until the surface is dense and smooth, true to grade, free from lumps and depressions, and then given a broom finish.
- G. After the concrete has thoroughly hardened but not more than twenty-four (24) hours after same is placed, it shall be covered with a layer of clean sand or burlap and thoroughly wet, and maintained for a period of seven (7) days and then removed. Membrane curing compound may be used with the Engineers approval.
- H. Where walks are poured against walls or structures, approved type expansion joints shall be installed between the walks and the wall or structure.

3.8 SEALING

- A. Old Asphalt Surfaces (**Jennite AE**):
 - 1. Repair and patch all pavement defects. Large hot mix patches should cure for a minimum of 30 days. Solvent containing cold patch materials should be placed a minimum of 90 days prior to the planned application of **Jennite AE** to permit solvent evaporation (curing) before sealing.
 - 2. Thoroughly inspect the pavement surface for minor cracks and other imperfections. Ignore hairline cracks. Open minor cracks (less than 1/2 inch) to a minimum depth and width of 1/2 inch and fill with a **Gem Seal** approved crack sealer or equal. Sunken spots or soft spots indicate that the pavement and the pavement base should be repaired or replaced.
 - 3. Remove oil or grease that has not permanently damaged or softened the pavement by scrubbing with a detergent and flushing with water until a water-break-free surface is obtained. Oil and grease spots with deeper penetration are treated by coating the spot with an approved oil spot primer. Do not use solvents to remove oil or grease as the solvents may

affect adhesion of the seal coat and may cause further pavement deterioration.

4. Remove and patch pavement that has been penetrated by oil and grease in accordance with the precautions described in step 1.
5. Treat old parking and traffic control lines with a prime coat. If control lines are excessively built up from multiple applications, abrade to the pavement surface before application of the prime coat.
6. Immediately prior to application of the seal coat, clean the surface of all loose dust, dirt, leaves, and other foreign materials by sweeping, and/or flushing with water.
7. Treat old, badly oxidized asphalt pavement or asphalt pavement that has lost binder by erosion leaving exposed aggregate with a prime coat of seal coat (diluted 1 to 1 with water). This prime coat is to dry thoroughly before proceeding. Application rate shall be 0.05 - 0.10 gallon per square yard of diluted seal coat.

B. New Asphalt Surfaces:

1. No seal coat required for new asphalt surfaces.

3.9 CRACK FILLING

- A. Preparatory Work: Crack should be dry, clean and free of all loose material, dirt and dust.
- B. Methods: May be used directly from 1 gallon spouted jug, pour pot, or suitable mechanized equipment.
- C. Mix Design: Do not dilute, use full strength. Mix well before use.
- D. Application: Fill crack with pourable crack filler, squeegee any excess flush with pavement surface. Allow to dry.

3.10 CRUSHED CONCRETE

- A. Crushed concrete shall be placed over a compacted base (12" minimum - 95% maximum density) to a depth off four inches(4") run after compaction (finished compaction to 100% maximum density). Placed crushed concrete shall match existing crushed concrete areas.

SODDING

DESCRIPTION

904-1.1 This item shall consist of furnishing, hauling, and placing approved live sod on prepared areas in accordance with this specification at the locations shown on the plans or as directed by the Engineer.

MATERIALS

904-2.1 SOD. Sod furnished by the Contractor shall have a good cover of living or growing grass. This shall be interpreted to include grass that is seasonally dormant during the cold or dry seasons and capable of renewing growth after the dormant period. All sod shall be obtained from areas where the soil is reasonably fertile and contains a high percentage of loamy topsoil. Sod shall be cut or stripped from living, thickly matted turf relatively free of weeds or other undesirable foreign plants, large stones, roots, or other materials which might be detrimental to the development of the sod or to future maintenance. At least 70% of the plants in the cut sod shall be composed of the species stated on the plans, and any vegetation more than 6 inches (150 mm) in height shall be mowed to a height of 3 inches (75 mm) or less before sod is lifted. Sod, including the soil containing the roots and the plant growth showing above, shall be cut uniformly to a thickness not less than that stated in the special provisions. Sod shall be chosen by St. Johns County Maintenance staff for each individual school.

904-2.2 LIME. Lime shall conform to the requirements of 901-2.2.

904-2.3 FERTILIZER. Fertilizer shall conform to the requirements of 901-2.3.

904-2.4 WATER. The water shall be sufficiently free from oil, acid, alkali, salt, or other harmful materials that would inhibit the growth of grass. It shall be subject to the approval of the Engineer prior to use.

904-2.5 SOIL FOR REPAIRS. The soil for fill and topsoiling of areas to be repaired shall conform to the requirements of 901-2.4.

CONSTRUCTION METHODS

904-3.1 GENERAL. Areas to be solid, strip, or spot sodded shall be shown on the plans. Areas requiring special ground surface preparation such as tilling and those areas in a satisfactory condition which are to remain undisturbed shall also be shown on the plans.

Suitable equipment necessary for proper preparation of the ground surface and for the handling and

placing of all required materials shall be on hand, in good condition, and shall be approved by the Engineer before the various operations are started. The Contractor shall demonstrate to the Engineer before starting the various operations that the application of required materials will be made at the specified rates.

904-3.2 PREPARING THE GROUND SURFACE. After grading of areas has been completed and before applying fertilizer and limestone, areas to be sodded shall be raked or otherwise cleared of stones larger than 2 inches (50 mm) in any diameter, sticks, stumps, and other debris which might interfere with sodding, growth of grasses, or subsequent maintenance of grass-covered areas. If any damage by erosion or other causes occurs after grading of areas and before beginning the application of fertilizer and ground limestone, the Contractor shall repair such damage. This may include filling gullies, smoothing irregularities, and repairing other incidental damage.

904-3.3 APPLYING FERTILIZER AND GROUND LIMESTONE. Following ground surface preparation, fertilizer shall be uniformly spread at a rate which will provide not less than the minimum quantity of each fertilizer ingredient, as stated in the special provisions. If use of ground limestone is required, it shall then be spread at a rate which will provide not less than the minimum quantity stated in the special provisions. These materials shall be incorporated into the soil to a depth of not less than 2 inches (50 mm) by discing, raking, or other methods acceptable to the Engineer. Any stones larger than 2 inches (50 mm) in any diameter, large clods, roots, and other litter brought to the surface by this operation shall be removed.

904-3.4 OBTAINING AND DELIVERING SOD. After inspection and approval of the source of sod by the Engineer, the sod shall be cut with approved sod cutters to such a thickness that after it has been transported and placed on the prepared bed, but before it has been compacted, it shall have a uniform thickness of not less than 2 inches (50 mm). Sod sections or strips shall be cut in uniform widths, not less than 10 inches (250 mm), and in lengths of not less than 18 inches (45 cm), but of such length as may be readily lifted without breaking, tearing, or loss of soil. Where strips are required, the sod must be rolled without damage with the grass folded inside. The Contractor may be required to mow high grass before cutting sod.

The sod shall be transplanted within 24 hours from the time it is stripped, unless circumstances beyond the Contractor's control make storing necessary. In such cases, sod shall be stacked, kept moist, and protected from exposure to the air and sun and shall be kept from freezing. Sod shall be cut and moved only when the soil moisture conditions are such that favorable results can be expected. Where the soil is too dry, permission to cut sod may be granted only after it has been watered sufficiently to moisten the soil to the depth the sod is to be cut.

904-3.5 LAYING SOD. Sodding shall be performed only during the seasons when satisfactory results can be expected. Frozen sod shall not be used and sod shall not be placed upon frozen soil. Sod may be transplanted during periods of drought with the approval of the Engineer, provided the

sod bed is watered to moisten the soil to a depth of at least 4 inches (100 mm) immediately prior to laying the sod.

The sod shall be moist and shall be placed on a moist earth bed. pitch forks shall not be used to handle sod, and dumping from vehicles shall not be permitted. The sod shall be carefully placed by hand, edge to edge and with staggered joints, in rows at right angles to the slopes, commencing at the base of the area to be sodded and working upward. The sod shall immediately be pressed firmly into contact with the sod bed by tamping or rolling with approved equipment to provide a true and even surface, and insure knitting without displacement of the sod or deformation of the surfaces of sodded areas. Where the sod may be displaced during sodding operations, the workmen when replacing it shall work from ladders or treaded planks to prevent further displacement. Screened soil of good quality shall be used to fill all cracks between sods. The quantity of the fill soil shall not cause smothering of the grass. Where the grades are such that the flow of water will be from paved surfaces across sodded areas, the surface of the soil in the sod after compaction shall be set approximately 1 inch (25 mm) below the pavement edge. Where the flow will be over the sodded areas and onto the paved surfaces around manholes and inlets, the surface of the soil in the sod after roller compaction shall be placed flush with pavement edges.

On slopes steeper than 1 vertical to 2-1/2 horizontal and in v-shaped or flat-bottom ditches or gutters, the sod shall be pegged with wooden pegs not less than 12 inches (300 mm) in length and have a cross-sectional area of not less than 3/4 square inch (18 square millimeter). The pegs shall be driven flush with the surface of the sod.

904-3.6 WATERING. Adequate water and watering equipment must be on hand before sodding begins, and sod shall be kept moist until it has become established and its continued growth assured. In all cases, watering shall be done in a manner which will avoid erosion from the application of excessive quantities and will avoid damage to the finished surface.

904-3.7 ESTABLISHING TURF.

a. General. The Contractor shall provide general care for the sodded areas as soon as the sod has been laid and shall continue until final inspection and acceptance of the work. Project will not be deemed complete until a healthy, mature stand of grass has been established.

b. Protection. All sodded areas shall be protected against traffic or other use by warning signs or barricades approved by the Engineer.

c. Mowing. The Contractor shall mow the sodded areas with approved mowing equipment, depending upon climatic and growth conditions and the needs for mowing specific areas. In the event that weeds or other undesirable vegetation are permitted to grow to such an extent that, either cut or uncut, they threaten to smother the sodded species, they shall be mowed

and the clippings raked and removed from the area.

904-3.8 REPAIRING. When the surface has become bullied or otherwise damaged during the period covered by this contract, the affected areas shall be repaired to re-establish the grade and the condition of the soil, as directed by the Engineer, and shall then be sodded as specified in 904-3.5.

METHOD OF MEASUREMENT

904-4.1 GENERAL. No work included in this item will be measured for payment. All work will be included in the Base Bid lump sum.

ST. JOHNS COUNTY SCHOOL DISTRICT PAVEMENT REHABILITATION (2016) BID NO. 2017-03

ST. JOHNS COUNTY, FLORIDA



ISSUED FOR BID

JANUARY 11, 2017



ST. JOHNS
COUNTY
SCHOOL
DISTRICT

ISSUED: MARCH, 31 2016
LAST REVISED: 4-18-16
PROJECT NUMBER: 98008.18

INDEX OF DRAWINGS

	COVER SHEET
C1.0	CUNNINGHAM CREEK ELEMENTARY
C2.0	MILL CREEK ELEMENTARY
C3.0	HARTLEY ELEMENTARY
C4.0	R.B. HUNT ELEMENTARY
C5.0	MASON ELEMENTARY
C6.0	OSCEOLA ELEMENTARY
C7.0	CREEKSIDE HIGH SCHOOL
C8.0	PONTE VEDRA HIGH SCHOOL
C9.0	LIBERTY PINES
C10.0	DETAILS / NOTES

P:\98\98008-18 S:\CSD 2016 PAVEMENT REHAB\CADD\CURRENT\98008-18BASE.DWG 1/6/2017 9:09:06 AM

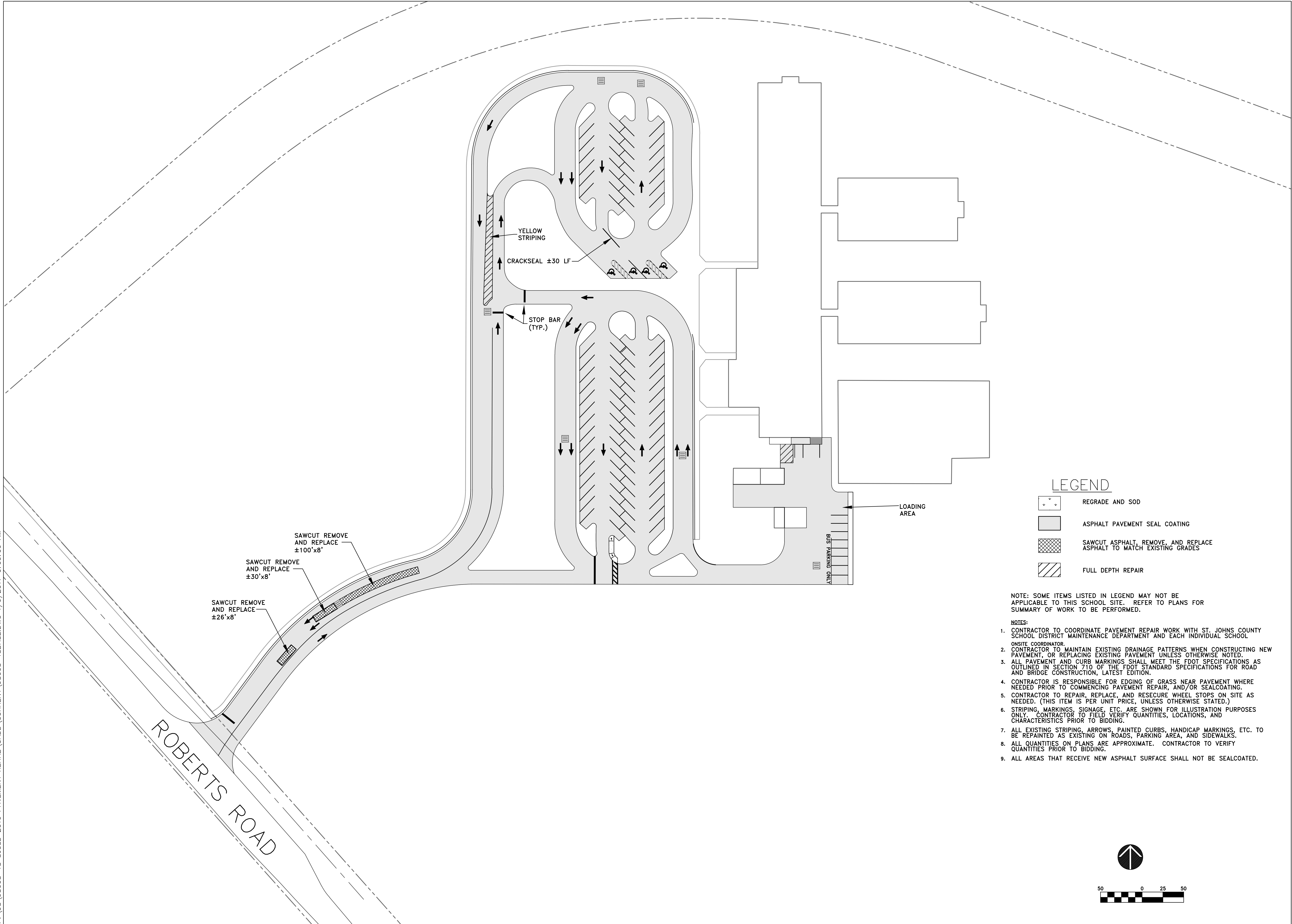

**PAVEMENT
REHABILITATION
2016**

LEGEND

- REGRADE AND SOD
- ASPHALT PAVEMENT SEAL COATING
- SAWCUT ASPHALT, REMOVE, AND REPLACE ASPHALT TO MATCH EXISTING GRADES
- FULL DEPTH REPAIR

NOTE: SOME ITEMS LISTED IN LEGEND MAY NOT BE APPLICABLE TO THIS SCHOOL SITE. REFER TO PLANS FOR SUMMARY OF WORK TO BE PERFORMED.

- NOTES:**
- CONTRACTOR TO COORDINATE PAVEMENT REPAIR WORK WITH ST. JOHNS COUNTY SCHOOL DISTRICT MAINTENANCE DEPARTMENT AND EACH INDIVIDUAL SCHOOL ON-SITE COORDINATOR.
 - CONTRACTOR TO MAINTAIN EXISTING DRAINAGE PATTERNS WHEN CONSTRUCTING NEW PAVEMENT, OR REPLACING EXISTING PAVEMENT UNLESS OTHERWISE NOTED.
 - ALL PAVEMENT AND CURB MARKINGS SHALL MEET THE FDOT SPECIFICATIONS AS OUTLINED IN SECTION 710 OF THE FDOT STANDARD SPECIFICATIONS FOR ROAD AND BRIDGE CONSTRUCTION, LATEST EDITION.
 - CONTRACTOR IS RESPONSIBLE FOR EDGING OF GRASS NEAR PAVEMENT WHERE NEEDED PRIOR TO COMMENCING PAVEMENT REPAIR, AND/OR SEALCOATING.
 - CONTRACTOR TO REPAIR, REPLACE, AND RESECURE WHEEL STOPS ON SITE AS NEEDED. (THIS ITEM IS PER UNIT PRICE, UNLESS OTHERWISE STATED.)
 - STRIPING, MARKINGS, SIGNAGE, ETC. ARE SHOWN FOR ILLUSTRATION PURPOSES ONLY. CONTRACTOR TO FIELD VERIFY QUANTITIES, LOCATIONS, AND CHARACTERISTICS PRIOR TO BIDDING.
 - ALL EXISTING STRIPING, ARROWS, PAINTED CURBS, HANDICAP MARKINGS, ETC. TO BE REPAINTED AS EXISTING ON ROADS, PARKING AREA, AND SIDEWALKS.
 - ALL QUANTITIES ON PLANS ARE APPROXIMATE. CONTRACTOR TO VERIFY QUANTITIES PRIOR TO BIDDING.
 - ALL AREAS THAT RECEIVE NEW ASPHALT SURFACE SHALL NOT BE SEALCOATED.

DATE : MARCH 16, 2016
PROJECT NO. : 98008-18
DESIGNED BY : RPS
DRAWN BY : AEK
SCALE : AS NOTED



No.	Date	Revision
1	01-11-17	ISSUED FOR BID

THIS DRAWING NOT RELEASED FOR CONSTRUCTION UNLESS SO NOTED ABOVE

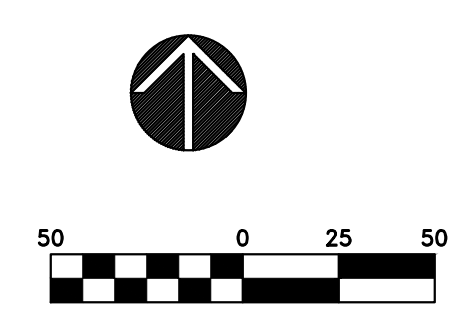
SHEET TITLE
**CUNNINGHAM
CREEK
ELEMENTARY**

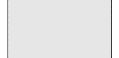

LEGEND

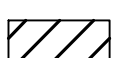
-  REGRADE AND SOD
-  ASPHALT PAVEMENT SEAL COATING
-  SAWCUT ASPHALT, REMOVE, AND REPLACE ASPHALT TO MATCH EXISTING GRADES
-  FULL DEPTH REPAIR

NOTE: SOME ITEMS LISTED IN LEGEND MAY NOT BE APPLICABLE TO THIS SCHOOL SITE. REFER TO PLANS FOR SUMMARY OF WORK TO BE PERFORMED.

- NOTES**
1. CONTRACTOR TO COORDINATE PAVEMENT REPAIR WORK WITH ST. JOHNS COUNTY SCHOOL DISTRICT MAINTENANCE DEPARTMENT AND EACH INDIVIDUAL SCHOOL ON-SITE COORDINATOR.
 2. CONTRACTOR TO MAINTAIN EXISTING DRAINAGE PATTERNS WHEN CONSTRUCTING NEW PAVEMENT, OR REPLACING EXISTING PAVEMENT UNLESS OTHERWISE NOTED.
 3. ALL PAVEMENT AND CURB MARKINGS SHALL MEET THE FDOT SPECIFICATIONS AS OUTLINED IN SECTION 710 OF THE FDOT STANDARD SPECIFICATIONS FOR ROAD AND BRIDGE CONSTRUCTION, LATEST EDITION.
 4. CONTRACTOR IS RESPONSIBLE FOR EDGING OF GRASS NEAR PAVEMENT WHERE NEEDED PRIOR TO COMMENCING PAVEMENT REPAIR, AND/OR SEALCOATING.
 5. CONTRACTOR TO REPAIR, REPLACE, AND RESECURE WHEEL STOPS ON SITE AS NEEDED. (THIS ITEM IS PER UNIT PRICE, UNLESS OTHERWISE STATED.)
 6. STRIPING, MARKINGS, SIGNAGE, ETC. ARE SHOWN FOR ILLUSTRATION PURPOSES ONLY. CONTRACTOR TO FIELD VERIFY QUANTITIES, LOCATIONS, AND CHARACTERISTICS PRIOR TO BIDDING.
 7. ALL EXISTING STRIPING, ARROWS, PAINTED CURBS, HANDICAP MARKINGS, ETC. TO BE REPAINTED AS EXISTING ON ROADS, PARKING AREA, AND SIDEWALKS.
 8. ALL QUANTITIES ON PLANS ARE APPROXIMATE. CONTRACTOR TO VERIFY QUANTITIES PRIOR TO BIDDING.
 9. ALL AREAS THAT RECEIVE NEW ASPHALT SURFACE SHALL NOT BE SEALCOATED.

**PAVEMENT
REHABILITATION
2016**

DATE: MARCH 16, 2016

PROJECT NO.: 98008.18

DESIGNED BY: RPS

DRAWN BY: AEK

SCALE: AS NOTED

No.	Date	Revision
1	01-11-17	ISSUED FOR BID

THIS DRAWING NOT RELEASED FOR CONSTRUCTION UNLESS SO NOTED ABOVE

SHEET TITLE

**MILL CREEK
ELEMENTARY**

C2.0

RYAN P. STILLWELL, P.E.
No. 66526
DATE:

SHEET

P:\98\98008-18_SUCSD_2016_PAVEMENT_REHAB\CADD\CURRENT\98008-18BASE.DWG 1/9/2017 3:55:20 PM

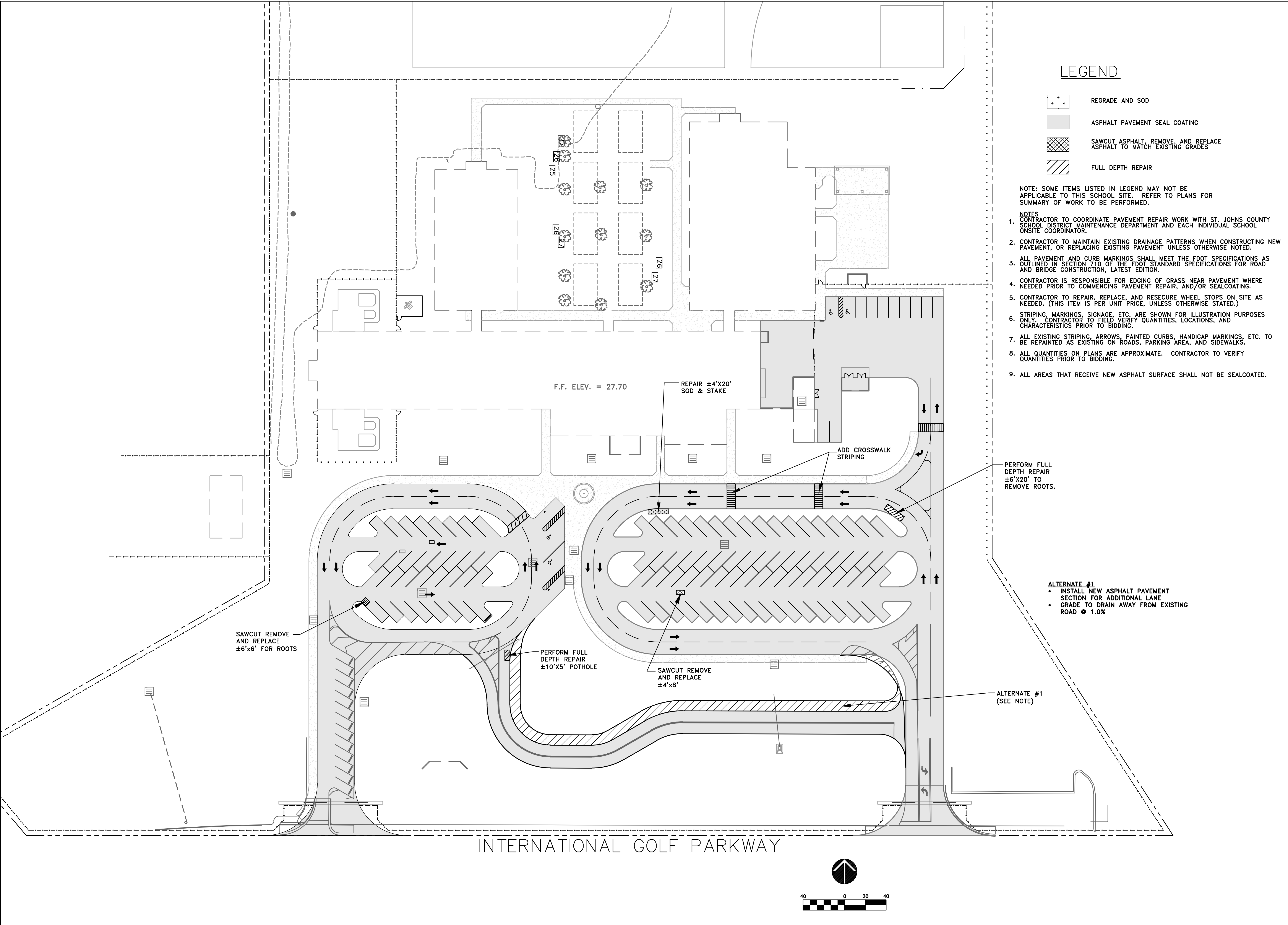

INTERNATIONAL GOLF PARKWAY

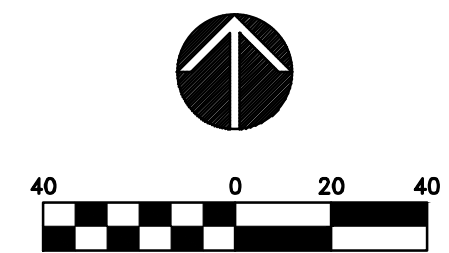

**PAVEMENT
REHABILITATION
2016**

DATE : MARCH 16, 2016
PROJECT NO. : 98008.18
DESIGNED BY : RPS
DRAWN BY : AEK
SCALE : AS NOTED

No.	Date	Revision
1	01-11-17	ISSUED FOR BID

THIS DRAWING NOT RELEASED FOR
CONSTRUCTION UNLESS SO NOTED
ABOVE.

SHEET TITLE

**W.D. HARTLEY
ELEMENTARY**

C3.0

RYAN P. STILWELL, P.E.
No. 66526
DATE:

S H E E T

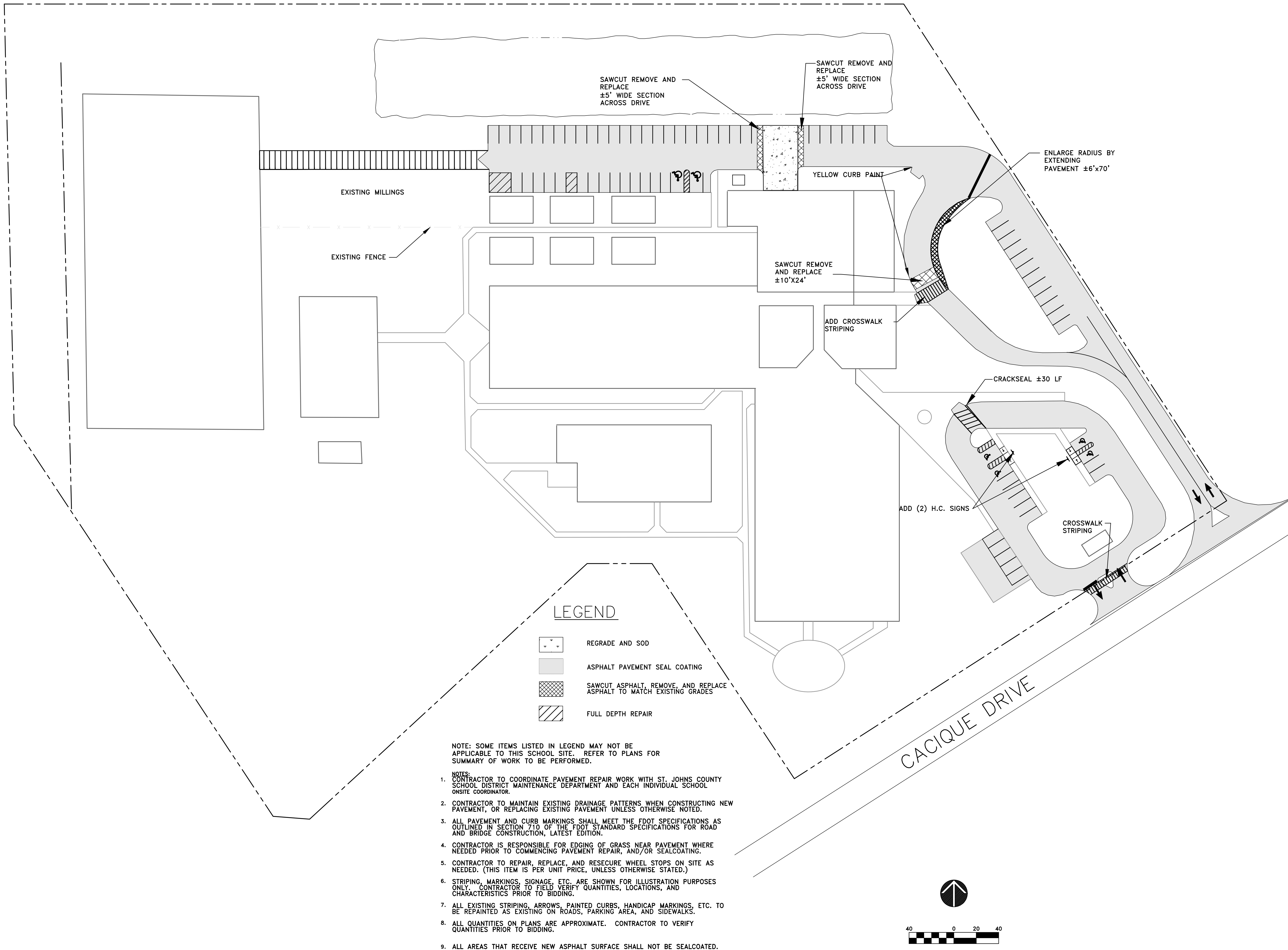

LEGEND



- REGRADE AND SOD
- ASPHALT PAVEMENT SEAL COATING
- SAWCUT ASPHALT, REMOVE, AND REPLACE ASPHALT TO MATCH EXISTING GRADES
- FULL DEPTH REPAIR

NOTE: SOME ITEMS LISTED IN LEGEND MAY NOT BE APPLICABLE TO THIS SCHOOL SITE. REFER TO PLANS FOR SUMMARY OF WORK TO BE PERFORMED.

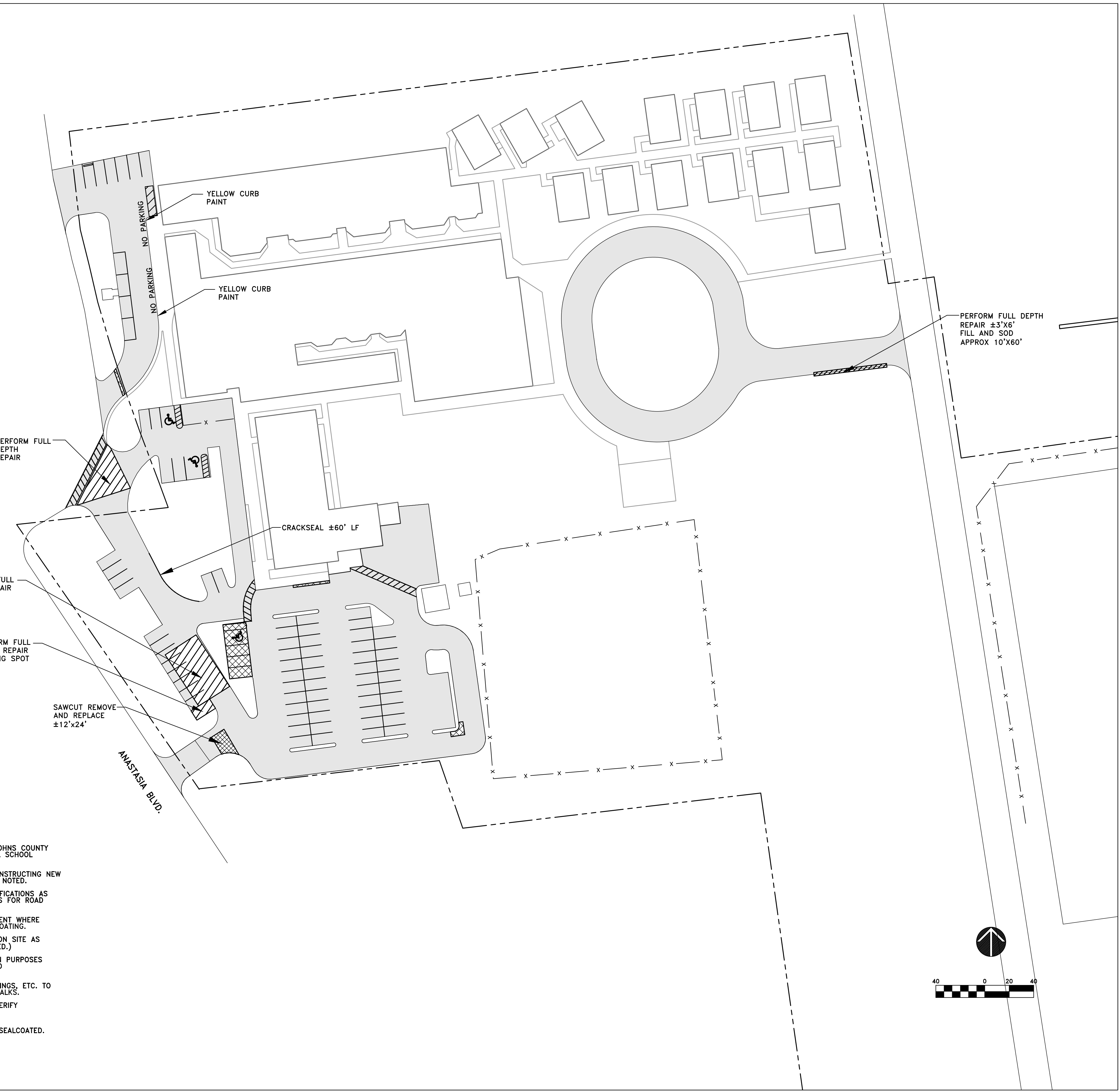
- NOTES:
1. CONTRACTOR TO COORDINATE PAVEMENT REPAIR WORK WITH ST. JOHNS COUNTY SCHOOL DISTRICT MAINTENANCE DEPARTMENT AND EACH INDIVIDUAL SCHOOL ON-SITE COORDINATOR.
 2. CONTRACTOR TO MAINTAIN EXISTING DRAINAGE PATTERNS WHEN CONSTRUCTING NEW PAVEMENT, OR REPLACING EXISTING PAVEMENT UNLESS OTHERWISE NOTED.
 3. ALL PAVEMENT AND CURB MARKINGS SHALL MEET THE FDOT SPECIFICATIONS AS OUTLINED IN SECTION 710 OF THE FDOT STANDARD SPECIFICATIONS FOR ROAD AND BRIDGE CONSTRUCTION, LATEST EDITION.
 4. CONTRACTOR IS RESPONSIBLE FOR EDGING OF GRASS NEAR PAVEMENT WHERE NEEDED PRIOR TO COMMENCING PAVEMENT REPAIR, AND/OR SEALCOATING.
 5. CONTRACTOR TO REPAIR, REPLACE, AND RESECURE WHEEL STOPS ON SITE AS NEEDED. (THIS ITEM IS PER UNIT PRICE, UNLESS OTHERWISE STATED.)
 6. STRIPING, MARKINGS, SIGNAGE, ETC. ARE SHOWN FOR ILLUSTRATION PURPOSES ONLY. CONTRACTOR TO FIELD VERIFY QUANTITIES, LOCATIONS, AND CHARACTERISTICS PRIOR TO BIDDING.
 7. ALL EXISTING STRIPING, ARROWS, PAINTED CURBS, HANDICAP MARKINGS, ETC. TO BE REPAINTED AS EXISTING ON ROADS, PARKING AREA, AND SIDEWALKS.
 8. ALL QUANTITIES ON PLANS ARE APPROXIMATE. CONTRACTOR TO VERIFY QUANTITIES PRIOR TO BIDDING.
 9. ALL AREAS THAT RECEIVE NEW ASPHALT SURFACE SHALL NOT BE SEALCOATED.

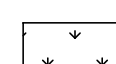

LEGEND

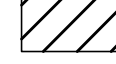
-  REGRADE AND SOD
-  ASPHALT PAVEMENT SEAL COATING
-  SAWCUT ASPHALT, REMOVE, AND REPLACE ASPHALT TO MATCH EXISTING GRADES
-  FULL DEPTH REPAIR

NOTE: SOME ITEMS LISTED IN LEGEND MAY NOT BE APPLICABLE TO THIS SCHOOL SITE. REFER TO PLANS FOR SUMMARY OF WORK TO BE PERFORMED.

NOTES

1. CONTRACTOR TO COORDINATE PAVEMENT REPAIR WORK WITH ST. JOHNS COUNTY SCHOOL DISTRICT MAINTENANCE DEPARTMENT AND EACH INDIVIDUAL SCHOOL ONSITE COORDINATOR.
2. CONTRACTOR TO MAINTAIN EXISTING DRAINAGE PATTERNS WHEN CONSTRUCTING NEW PAVEMENT, OR REPLACING EXISTING PAVEMENT UNLESS OTHERWISE NOTED.
3. ALL PAVEMENT AND CURB MARKINGS SHALL MEET THE FDOT SPECIFICATIONS AS OUTLINED IN SECTION 710 OF THE FDOT STANDARD SPECIFICATIONS FOR ROAD AND BRIDGE CONSTRUCTION, LATEST EDITION.
4. CONTRACTOR IS RESPONSIBLE FOR EDGING OF GRASS NEAR PAVEMENT WHERE NEEDED PRIOR TO COMMENCING PAVEMENT REPAIR, AND/OR SEALCOATING.
5. CONTRACTOR TO REPAIR, REPLACE, AND RESECURE WHEEL STOPS ON SITE AS NEEDED. (THIS ITEM IS PER UNIT PRICE, UNLESS OTHERWISE STATED.)
6. STRIPING, MARKINGS, SIGNAGE, ETC. ARE SHOWN FOR ILLUSTRATION PURPOSES ONLY. CONTRACTOR TO FIELD VERIFY QUANTITIES, LOCATIONS, AND CHARACTERISTICS PRIOR TO BIDDING.
7. ALL EXISTING STRIPING, ARROWS, PAINTED CURBS, HANDICAP MARKINGS, ETC. TO BE REPAINTED AS EXISTING ON ROADS, PARKING AREA, AND SIDEWALKS.
8. ALL QUANTITIES ON PLANS ARE APPROXIMATE. CONTRACTOR TO VERIFY QUANTITIES PRIOR TO BIDDING.
9. ALL AREAS THAT RECEIVE NEW ASPHALT SURFACE SHALL NOT BE SEALCOATED.

**PAVEMENT
 REHABILITATION
 2016**

DATE : MARCH 16, 2016
 PROJECT NO. : 98008.18
 DESIGNED BY : RPS
 DRAWN BY : AEK
 SCALE : AS NOTED

No.	Date	Revision
1	01-11-17	ISSUED FOR BID

THIS DRAWING NOT RELEASED FOR CONSTRUCTION UNLESS SO NOTED ABOVE

SHEET TITLE

**R.B. HUNT
 ELEMENTARY**

C4.0

RYAN P. STILLWELL, P.E.
 No. 66526
 DATE: _____
 S H E E T

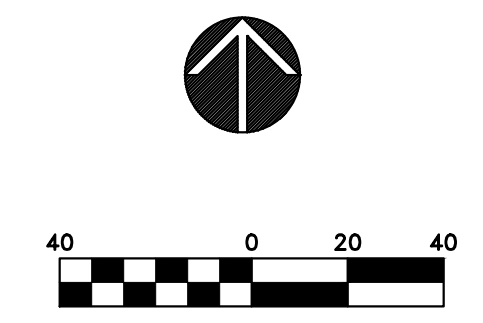
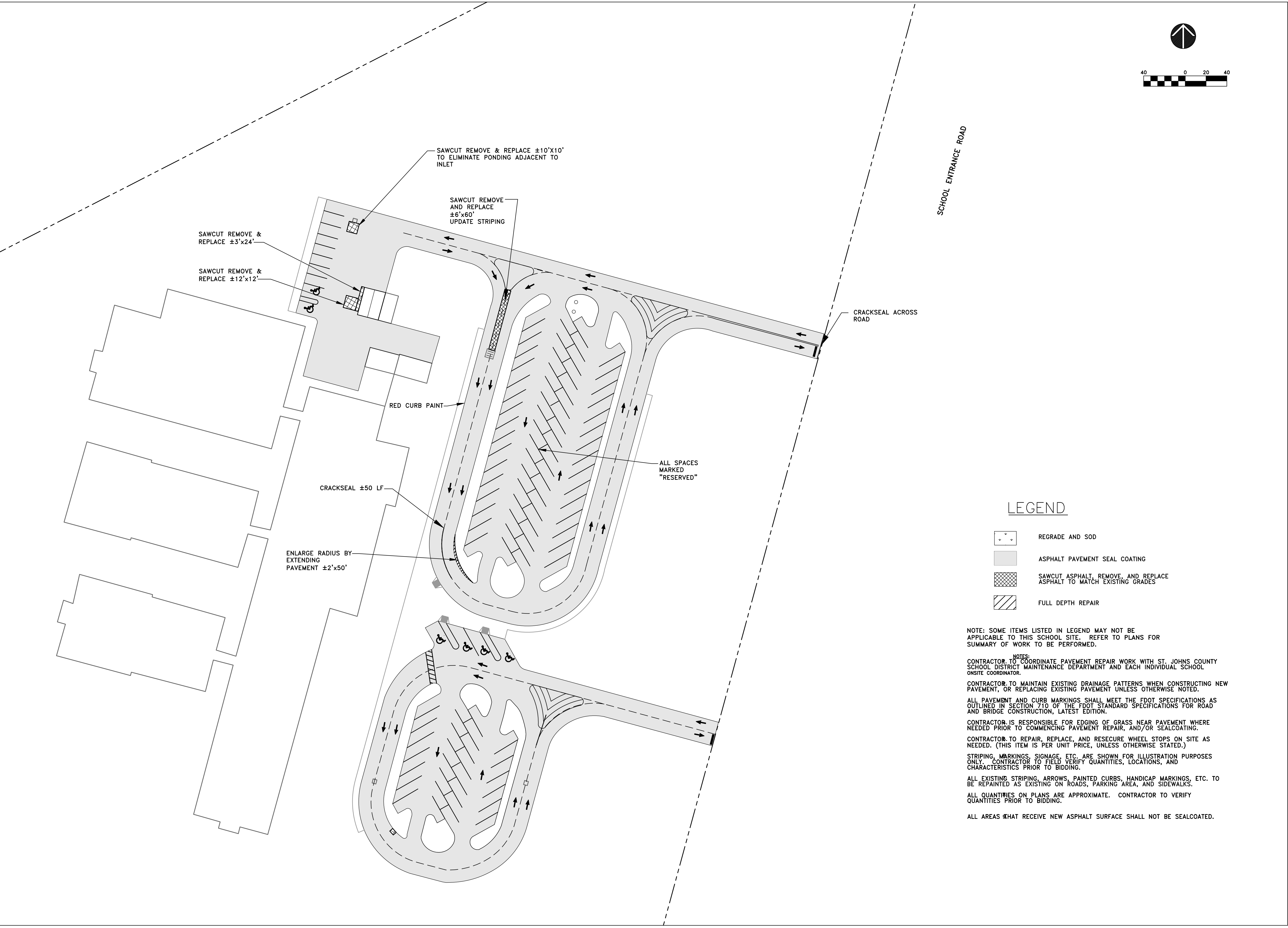

P:\98\98008-18_SJCSD_2016_PAVEMENT_REHAB\CADD\CURRENT\98008-18BASE.DWG 1/6/2017 9:12:16 AM



SCHOOL ENTRANCE ROAD

CRACKSEAL ACROSS ROAD

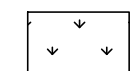
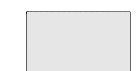
LEGEND

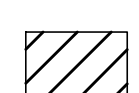
-  REGRADE AND SOD
-  ASPHALT PAVEMENT SEAL COATING
-  SAWCUT ASPHALT, REMOVE, AND REPLACE ASPHALT TO MATCH EXISTING GRADES
-  FULL DEPTH REPAIR

NOTE: SOME ITEMS LISTED IN LEGEND MAY NOT BE APPLICABLE TO THIS SCHOOL SITE. REFER TO PLANS FOR SUMMARY OF WORK TO BE PERFORMED.

NOTES:
CONTRACTOR TO COORDINATE PAVEMENT REPAIR WORK WITH ST. JOHNS COUNTY SCHOOL DISTRICT MAINTENANCE DEPARTMENT AND EACH INDIVIDUAL SCHOOL ON-SITE COORDINATOR.

CONTRACTOR TO MAINTAIN EXISTING DRAINAGE PATTERNS WHEN CONSTRUCTING NEW PAVEMENT, OR REPLACING EXISTING PAVEMENT UNLESS OTHERWISE NOTED.

ALL PAVEMENT AND CURB MARKINGS SHALL MEET THE FDOT SPECIFICATIONS AS OUTLINED IN SECTION 710 OF THE FDOT STANDARD SPECIFICATIONS FOR ROAD AND BRIDGE CONSTRUCTION, LATEST EDITION.

CONTRACTOR IS RESPONSIBLE FOR EDGING OF GRASS NEAR PAVEMENT WHERE NEEDED PRIOR TO COMMENCING PAVEMENT REPAIR, AND/OR SEALCOATING.

CONTRACTOR TO REPAIR, REPLACE, AND RESECURE WHEEL STOPS ON SITE AS NEEDED. (THIS ITEM IS PER UNIT PRICE, UNLESS OTHERWISE STATED.)

STRIPING, MARKINGS, SIGNAGE, ETC. ARE SHOWN FOR ILLUSTRATION PURPOSES ONLY. CONTRACTOR TO FIELD VERIFY QUANTITIES, LOCATIONS, AND CHARACTERISTICS PRIOR TO BIDDING.

ALL EXISTING STRIPING, ARROWS, PAINTED CURBS, HANDICAP MARKINGS, ETC. TO BE REPAINTED AS EXISTING ON ROADS, PARKING AREA, AND SIDEWALKS.

ALL QUANTITIES ON PLANS ARE APPROXIMATE. CONTRACTOR TO VERIFY QUANTITIES PRIOR TO BIDDING.

ALL AREAS THAT RECEIVE NEW ASPHALT SURFACE SHALL NOT BE SEALCOATED.

PROSSER
Community - Management - Energy - Relationships
13901 Sutton Park Drive South, Suite 200
Jacksonville, Florida 32224-0229
Office 904.739.3655
Fax 904.730.3413
www.prosserinc.com
Florida Certificate of Authorization
Number: 00004050

PAVEMENT REHABILITATION 2016

DATE : MARCH 16, 2016
 PROJECT NO. : 98008.18
 DESIGNED BY : RPS
 DRAWN BY : AEK
 SCALE : AS NOTED

No.	Date	Revision
1	01-11-17	ISSUED FOR BID

THIS DRAWING NOT RELEASED FOR CONSTRUCTION UNLESS SO NOTED ABOVE.

SHEET TITLE

OTIS A. MASON ELEMENTARY

C5.0
 RYAN P. STILWELL, P.E.
 No. 66526
 DATE: _____ SHEET

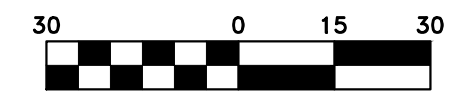

PROSSERTM
Community - Management - Energy - Relationships

13901 Sutton Park Drive South, Suite 200
Jacksonville, Florida 32224-0229

Office 904.739.3655
Fax 904.730.3413

www.prosserinc.com

Florida Certificate of Authorization
Number: 00004050

**PAVEMENT
REHABILITATION
2016**

LEGEND

- REGRADE AND SOD
- ASPHALT PAVEMENT SEAL COATING
- SAWCUT ASPHALT, REMOVE, AND REPLACE ASPHALT TO MATCH EXISTING GRADES
- FULL DEPTH REPAIR

NOTE: SOME ITEMS LISTED IN LEGEND MAY NOT BE APPLICABLE TO THIS SCHOOL SITE. REFER TO PLANS FOR SUMMARY OF WORK TO BE PERFORMED.

NOTES

1. CONTRACTOR TO COORDINATE PAVEMENT REPAIR WORK WITH ST. JOHNS COUNTY SCHOOL DISTRICT MAINTENANCE DEPARTMENT AND EACH INDIVIDUAL SCHOOL ONSITE COORDINATOR.
2. CONTRACTOR TO MAINTAIN EXISTING DRAINAGE PATTERNS WHEN CONSTRUCTING NEW PAVEMENT, OR REPLACING EXISTING PAVEMENT UNLESS OTHERWISE NOTED.
3. ALL PAVEMENT AND CURB MARKINGS SHALL MEET THE FDOT SPECIFICATIONS AS OUTLINED IN SECTION 710 OF THE FDOT STANDARD SPECIFICATIONS FOR ROAD AND BRIDGE CONSTRUCTION, LATEST EDITION.
4. CONTRACTOR IS RESPONSIBLE FOR EDGING OF GRASS NEAR PAVEMENT WHERE NEEDED PRIOR TO COMMENCING PAVEMENT REPAIR, AND/OR SEALCOATING.
5. CONTRACTOR TO REPAIR, REPLACE, AND RESECURE WHEEL STOPS ON SITE AS NEEDED. (THIS ITEM IS PER UNIT PRICE, UNLESS OTHERWISE STATED.)
6. STRIPING, MARKINGS, SIGNAGE, ETC. ARE SHOWN FOR ILLUSTRATION PURPOSES ONLY. CONTRACTOR TO FIELD VERIFY QUANTITIES, LOCATIONS, AND CHARACTERISTICS PRIOR TO BIDDING.
7. ALL EXISTING STRIPING, ARROWS, PAINTED CURBS, HANDICAP MARKINGS, ETC. TO BE REPAINTED AS EXISTING ON ROADS, PARKING AREA, AND SIDEWALKS.
8. ALL QUANTITIES ON PLANS ARE APPROXIMATE. CONTRACTOR TO VERIFY QUANTITIES PRIOR TO BIDDING.
9. ALL AREAS THAT RECEIVE NEW ASPHALT SURFACE SHALL NOT BE SEALCOATED.

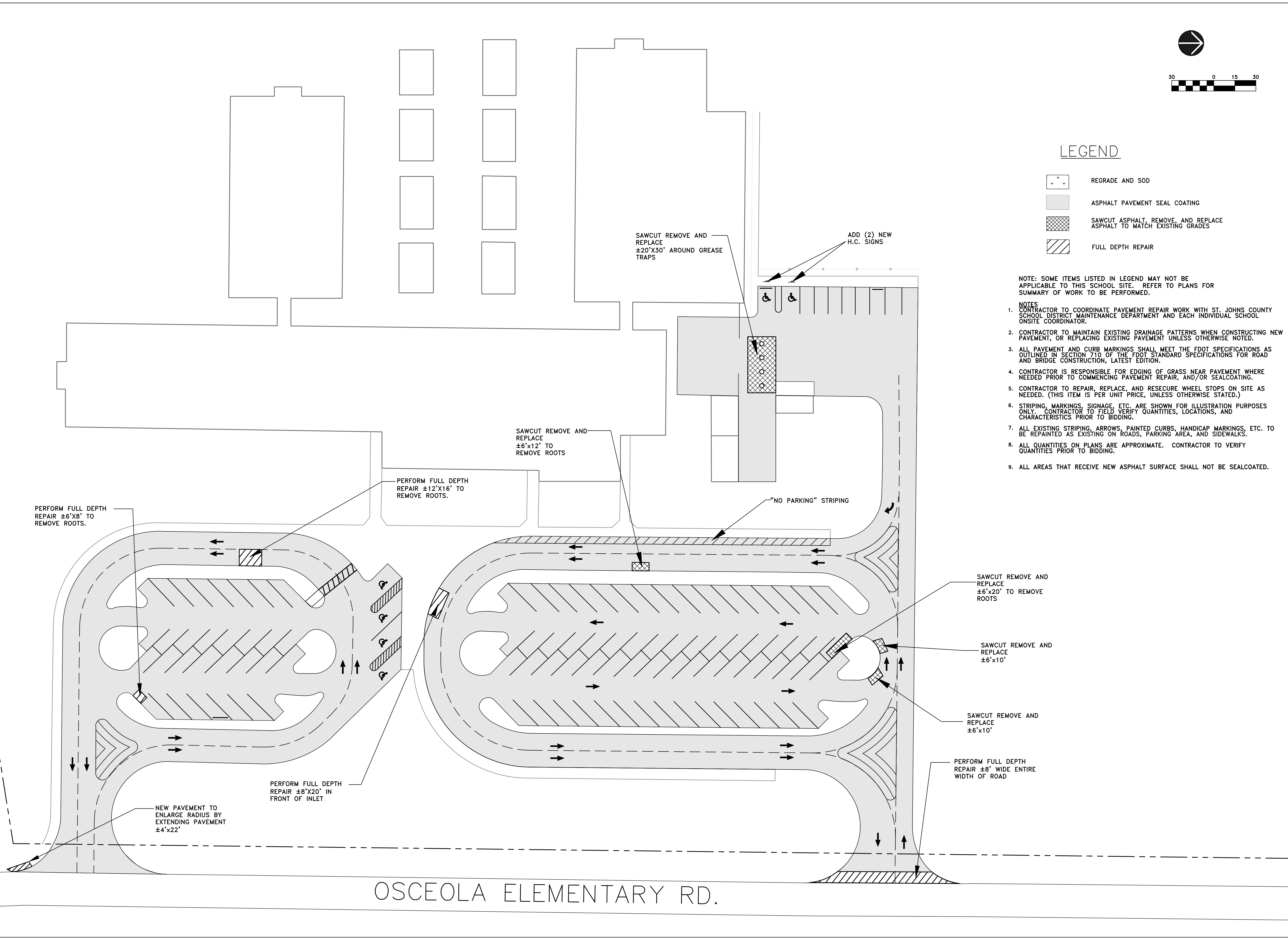

OSCEOLA ELEMENTARY RD.

DATE : MARCH 16, 2016

PROJECT NO. : 98008.18

DESIGNED BY : RPS

DRAWN BY : AEK

SCALE : AS NOTED

No.	Date	Revision
1	01-11-17	ISSUED FOR BID

THIS DRAWING NOT RELEASED FOR CONSTRUCTION UNLESS SO NOTED ABOVE

SHEET TITLE

**OSCEOLA
ELEMENTARY**

C6.0

RYAN P. STILWELL, P.E.
No. 66526

SHEET

P:\98\98008-18_SJCSO.2016_PAVEMENT_REHAB\CADD\CURRENT\98008-18BASE.DWG 1/6/2017 9:13:07 AM

**PAVEMENT
REHABILITATION
2016**

DATE : MARCH 16, 2016

PROJECT NO. : 98008.18

DESIGNED BY : RPS

DRAWN BY : AEK

SCALE : AS NOTED

No.	Date	Revision
1	01-11-17	ISSUED FOR BID

THIS DRAWING NOT RELEASED FOR CONSTRUCTION UNLESS SO NOTED ABOVE

SHEET TITLE

**CREEKSIDE
HIGH SCHOOL**

C7.0

RYAN P. STILWELL, P.E.
No. 66526
DATE: _____ S H E E T

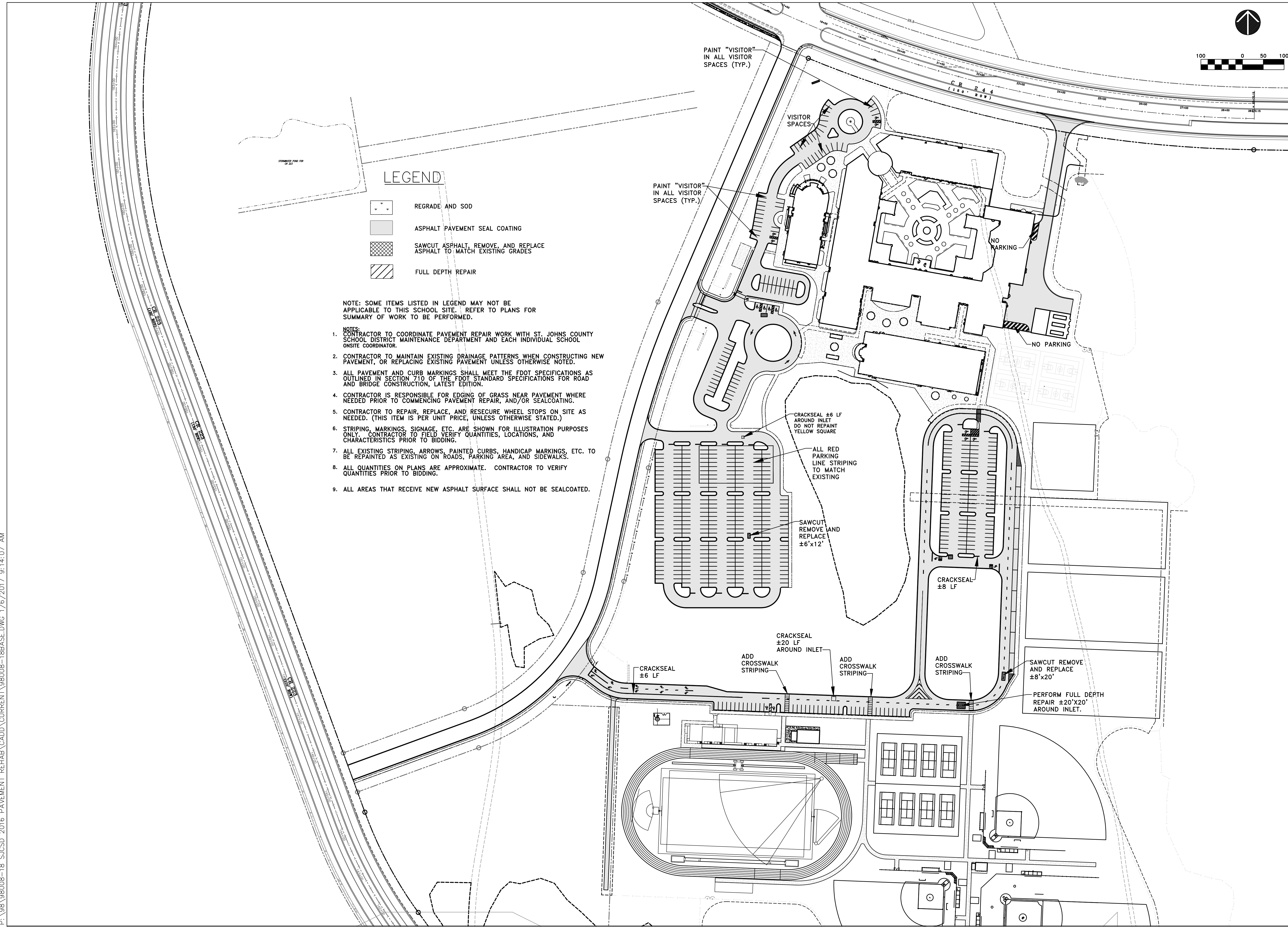

P:\98\98008-18_SUCSD_2016_PAVEMENT_REHAB\CADD\CURRENT\98008-18BASE.DWG 1/6/2017 9:14:07 AM

PAVEMENT REHABILITATION 2016

DATE : MARCH 16, 2016

PROJECT NO. : 98008.18

DESIGNED BY : RPS

DRAWN BY : AEK

SCALE : AS NOTED

No.	Date	Revision
1	01-11-17	ISSUED FOR BID

THIS DRAWING NOT RELEASED FOR
CONSTRUCTION UNLESS SO NOTED
ABOVE

SHEET TITLE

PONTE VEDRA HIGH SCHOOL

C8.0

RYAN P. STILLWELL, P.E.
No. 66526
DATE:

SHEET

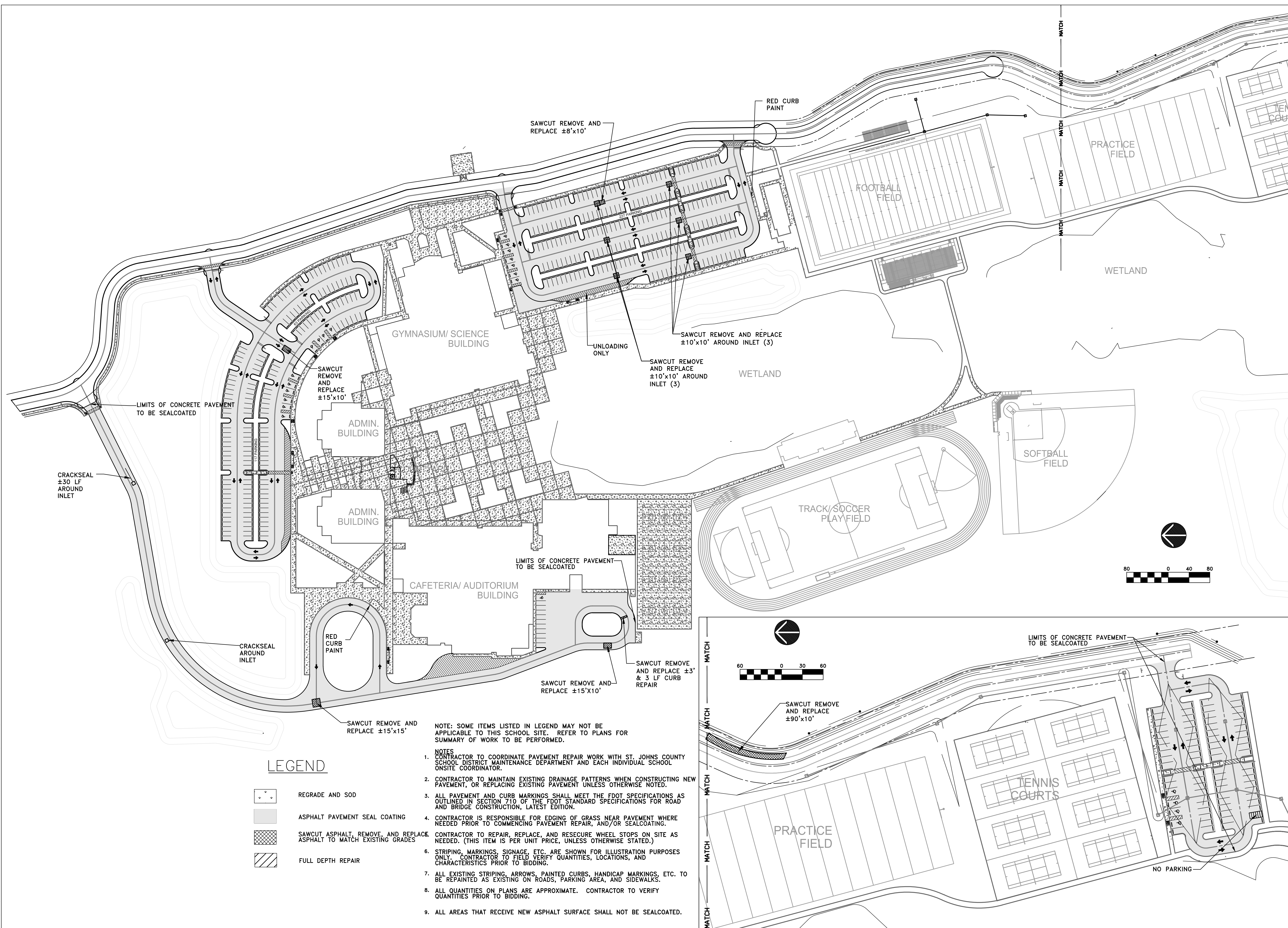

LEGEND

- REGRADE AND SOD
- ASPHALT PAVEMENT SEAL COATING
- SAWCUT ASPHALT REMOVE AND REPLACE ASPHALT TO MATCH EXISTING GRADES
- FULL DEPTH REPAIR



- NOTE: SOME ITEMS LISTED IN LEGEND MAY NOT BE APPLICABLE TO THIS SCHOOL SITE. REFER TO PLANS FOR SUMMARY OF WORK TO BE PERFORMED.
- NOTES
- CONTRACTOR TO COORDINATE PAVEMENT REPAIR WORK WITH ST. JOHNS COUNTY SCHOOL DISTRICT MAINTENANCE DEPARTMENT AND EACH INDIVIDUAL SCHOOL ON-SITE COORDINATOR.
 - CONTRACTOR TO MAINTAIN EXISTING DRAINAGE PATTERNS WHEN CONSTRUCTING NEW PAVEMENT, OR REPLACING EXISTING PAVEMENT UNLESS OTHERWISE NOTED.
 - ALL PAVEMENT AND CURB MARKINGS SHALL MEET THE FDOT STANDARD SPECIFICATIONS AS OUTLINED IN SECTION 710 OF THE FDOT STANDARD SPECIFICATIONS FOR ROAD AND BRIDGE CONSTRUCTION, LATEST EDITION.
 - CONTRACTOR IS RESPONSIBLE FOR EDGING OF GRASS NEAR PAVEMENT WHERE NEEDED PRIOR TO COMMENCING PAVEMENT REPAIR, AND/OR SEALCOATING.
 - CONTRACTOR TO REPAIR, REPLACE, AND RESECURE WHEEL STOPS ON SITE AS NEEDED. (THIS ITEM IS PER UNIT PRICE, UNLESS OTHERWISE STATED.)
 - STRIPING, MARKINGS, SIGNAGE, ETC. ARE SHOWN FOR ILLUSTRATION PURPOSES ONLY. CONTRACTOR TO FIELD VERIFY QUANTITIES, LOCATIONS, AND CHARACTERISTICS PRIOR TO BIDDING.
 - ALL EXISTING STRIPING, ARROWS, PAINTED CURBS, HANDICAP MARKINGS, ETC. TO BE REPAINTED AS EXISTING ON ROADS, PARKING AREA, AND SIDEWALKS.
 - ALL QUANTITIES ON PLANS ARE APPROXIMATE. CONTRACTOR TO VERIFY QUANTITIES PRIOR TO BIDDING.
 - ALL AREAS THAT RECEIVE NEW ASPHALT SURFACE SHALL NOT BE SEALCOATED.

P:\98\98008-18_SJCSD 2016 PAVEMENT REHAB\CADD\CURRENT\98008-18BASE.DWG 1/6/2017 9:14:56 AM

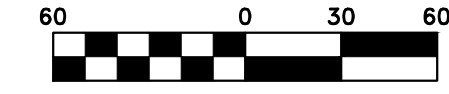
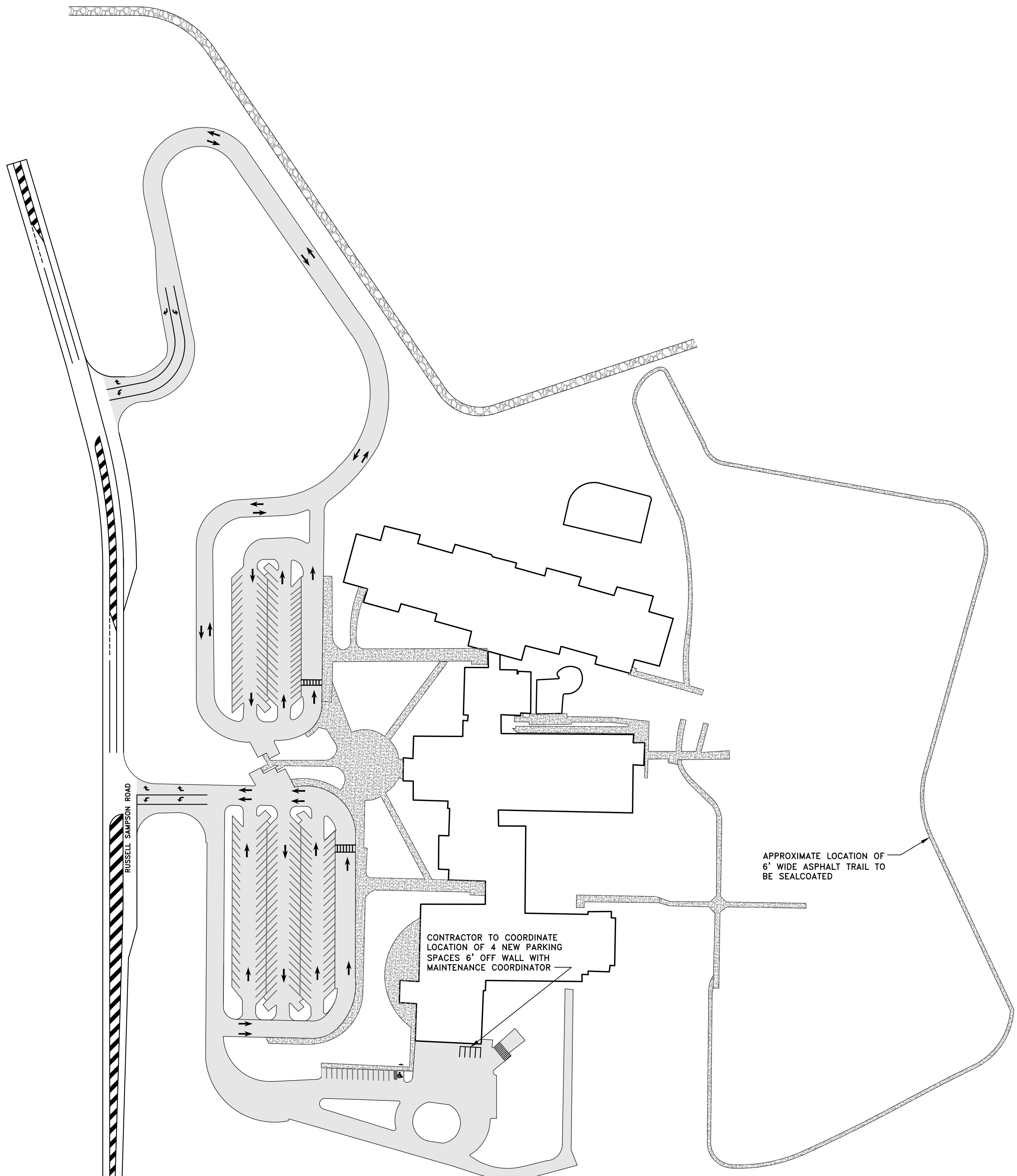
P:\08\980008-18 S\JCS\2016 PAVEMENT REHAB\CADD\CURRENT\980008-18BASE.DWG 1/6/2017 9:15:41 AM

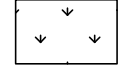

LEGEND

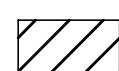
-  REGRADE AND SOD
-  ASPHALT PAVEMENT SEAL COATING
-  SAWCUT ASPHALT, REMOVE, AND REPLACE ASPHALT TO MATCH EXISTING GRADES
-  FULL DEPTH REPAIR

NOTE: SOME ITEMS LISTED IN LEGEND MAY NOT BE APPLICABLE TO THIS SCHOOL SITE. REFER TO PLANS FOR SUMMARY OF WORK TO BE PERFORMED.

- NOTES:**
1. CONTRACTOR TO COORDINATE PAVEMENT REPAIR WORK WITH ST. JOHNS COUNTY SCHOOL DISTRICT MAINTENANCE DEPARTMENT AND EACH INDIVIDUAL SCHOOL ON-SITE COORDINATOR.
 2. CONTRACTOR TO MAINTAIN EXISTING DRAINAGE PATTERNS WHEN CONSTRUCTING NEW PAVEMENT, OR REPLACING EXISTING PAVEMENT UNLESS OTHERWISE NOTED.
 3. ALL PAVEMENT AND CURB MARKINGS SHALL MEET THE FDOT SPECIFICATIONS AS OUTLINED IN SECTION 710 OF THE FDOT STANDARD SPECIFICATIONS FOR ROAD AND BRIDGE CONSTRUCTION, LATEST EDITION.
 4. CONTRACTOR IS RESPONSIBLE FOR EDGING OF GRASS NEAR PAVEMENT WHERE NEEDED PRIOR TO COMMENCING PAVEMENT REPAIR, AND/OR SEALCOATING.
 5. CONTRACTOR TO REPAIR, REPLACE, AND RESECURE WHEEL STOPS ON SITE AS NEEDED. (THIS ITEM IS PER UNIT PRICE, UNLESS OTHERWISE STATED.)
 6. STRIPING, MARKINGS, SIGNAGE, ETC. ARE SHOWN FOR ILLUSTRATION PURPOSES ONLY. CONTRACTOR TO FIELD VERIFY QUANTITIES, LOCATIONS, AND CHARACTERISTICS PRIOR TO BIDDING.
 7. ALL EXISTING STRIPING, ARROWS, PAINTED CURBS, HANDICAP MARKINGS, ETC. TO BE REPAINTED AS EXISTING ON ROADS, PARKING AREA, AND SIDEWALKS.
 8. ALL QUANTITIES ON PLANS ARE APPROXIMATE. CONTRACTOR TO VERIFY QUANTITIES PRIOR TO BIDDING.
 9. ALL AREAS THAT RECEIVE NEW ASPHALT SURFACE SHALL NOT BE SEALCOATED.

CONTRACTOR TO COORDINATE LOCATION OF 4 NEW PARKING SPACES 6' OFF WALL WITH MAINTENANCE COORDINATOR

APPROXIMATE LOCATION OF 6' WIDE ASPHALT TRAIL TO BE SEALCOATED

PROSSERTM
 Community - Management - Energy - Relationships
 13901 Sutton Park Drive South, Suite 200
 Jacksonville, Florida 32224-0229
 Office 904.739.3655
 Fax 904.730.3413
 www.prosserinc.com
 Florida Certificate of Authorization
 Number: 00004050

**PAVEMENT
 REHABILITATION
 2016**

DATE : MARCH 16, 2016
 PROJECT NO. : 98008.18
 DESIGNED BY : RPS
 DRAWN BY : AEK
 SCALE : AS NOTED

No.	Date	Revision
1	01-11-17	ISSUED FOR BID

THIS DRAWING NOT RELEASED FOR CONSTRUCTION UNLESS SO NOTED ABOVE

SHEET TITLE

**LIBERTY PINES
 ELEMENTARY**

C9.0

RYAN P. STILLWELL, P.E.
 No. 66526
 DATE: _____

S H E E T

PAVEMENT REHABILITATION 2016

GENERAL NOTES

1. ALL PHASES OF SITE WORK FOR THIS PROJECT SHALL MEET OR EXCEED THE OWNER / DEVELOPER SITE WORK SPECIFICATIONS.
2. CONTRACTOR TO COORDINATE ALL WORK WITH ST. JOHNS COUNTY SCHOOL DISTRICT MAINTENANCE DEPT.
3. THE GENERAL CONTRACTOR WILL BE HELD SOLELY RESPONSIBLE FOR AND SHALL TAKE ALL PRECAUTIONS NECESSARY TO AVOID PROPERTY DAMAGE TO ADJACENT PROPERTIES DURING THE CONSTRUCTION PHASES OF THIS PROJECT.
4. SAFETY NOTICE TO THE CONTRACTOR
IN ACCORDANCE WITH GENERALLY ACCEPTED CONSTRUCTION PRACTICES, THE CONTRACTOR SHALL BE SOLELY AND COMPLETELY RESPONSIBLE FOR CONDITIONS OF THE JOB SITE, INCLUDING SAFETY OF ALL PERSONS AND PROPERTY DURING PERFORMANCE OF THE WORK. THIS REQUIREMENT WILL APPLY CONTINUOUSLY AND NOT BE LIMITED TO NORMAL WORKING HOURS. ANY CONSTRUCTION OBSERVATION BY THE ENGINEER OF THE CONTRACTOR'S PERFORMANCE IS NOT INTENDED TO INCLUDE REVIEW OF THE ADEQUACY OF THE CONTRACTOR'S SAFETY MEASURES IN, ON OR NEAR THE CONSTRUCTION SITE.
5. THE CONTRACTOR SHALL EXERCISE EXTREME CAUTION WHILE WORKING IN AREAS NEAR EXISTING STRUCTURES AND UTILITIES. THE CONTRACTOR SHALL REPAIR OR PAY FOR ANY DAMAGES MADE TO EXISTING STRUCTURES AND UTILITIES. (INCLUDING IRRIGATION LINES, ELECTRIC LINES, WATER AND SEWER ETC.)
6. CONTRACTOR SHALL INSURE THAT ALL DRAINAGE STRUCTURES, PIPES, ETC., ARE CLEANED OUT AND WORKING PROPERLY AT TIME OF COMPLETION.
7. ALL DISTURBED AREAS SHALL BE DRESSED, GRADED, FERTILIZED, MULCHED AND MAINTAINED UNTIL A PERMANENT VEGETATIVE COVER IS ESTABLISHED.
8. THE CONTRACTOR SHALL OBTAIN ALL PERMITS NECESSARY TO COMPLETE THE CONSTRUCTION AND ALL WORK SHALL BE DONE IN ACCORDANCE WITH PERMIT CONDITIONS.
9. AFTER PREPARATION OF SUBGRADE AND PRIOR TO CONSTRUCTION OF BASE COURSE, THE CONTRACTOR SHALL INSPECT THE SUBGRADE AND SHALL COORDINATE WITH THE OWNER TO MAKE RECOMMENDATIONS FOR INSTALLATION OF UNDERDRAIN.
10. ANY UNSUITABLE MATERIAL ENCOUNTERED SHALL BE REMOVED FROM THE SITE. EXCESS SUITABLE FILL MATERIAL SHALL BE STOCKPILED ON-SITE AT A LOCATION TO BE DETERMINED BY THE OWNER. THE CONTRACTOR SHALL BE RESPONSIBLE FOR THE REMOVAL OF ALL UNSUITABLE MATERIAL AND REPLACEMENT WITH STRUCTURAL FILL OR SUITABLE BACKFILL MATERIAL.
11. CONTRACTOR TO CONFIRM THAT CURRENT PARKING LOT LAYOUT MEETS ADA STANDARDS FOR THE STRIPING OF HANDICAPPED PARKING SPACES. IF THERE ARE INSUFFICIENTLY SIZED HANDICAP SPACES THE CONTRACTOR IS TO LAYOUT SPACES ACCORDING TO DETAIL ON THIS SHEET.
12. THE CONTRACTOR IS RESPONSIBLE FOR EDGING OF GRASS NEAR PAVEMENT WHERE NEEDED PRIOR TO SEALCOATING, STRIPING, AND REPAINTING CURBS.
13. THE CONTRACTOR SHALL SUBMIT SHOP DRAWINGS FOR ASPHALT AND CONCRETE PAVEMENT TO THE ENGINEER FOR REVIEW.

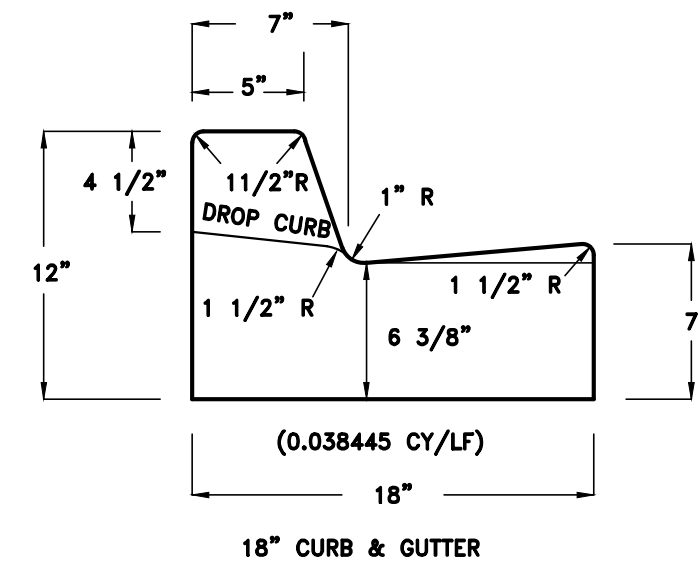

TYPICAL CURB DETAIL

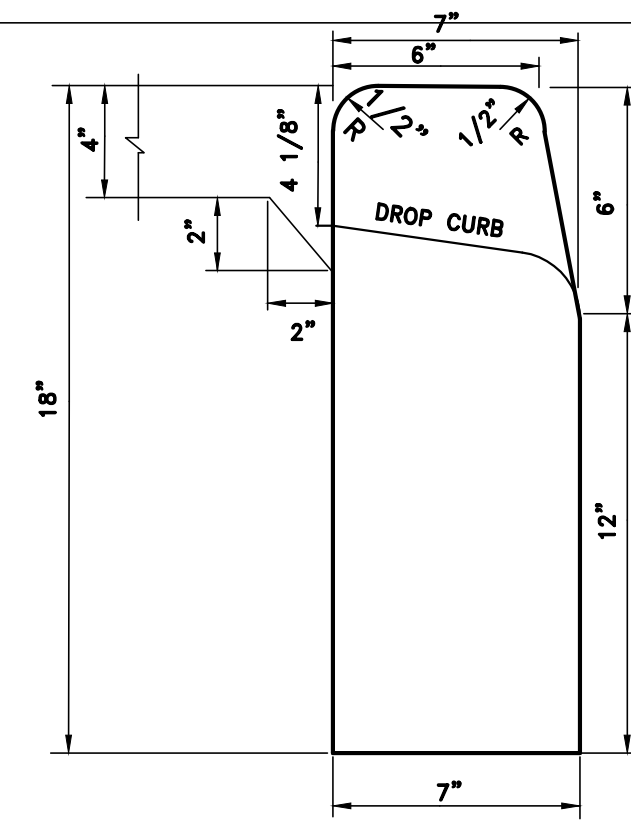

.0310114 SQ. YDS. PER LINEAR FOOT

HEADER CURB DETAIL

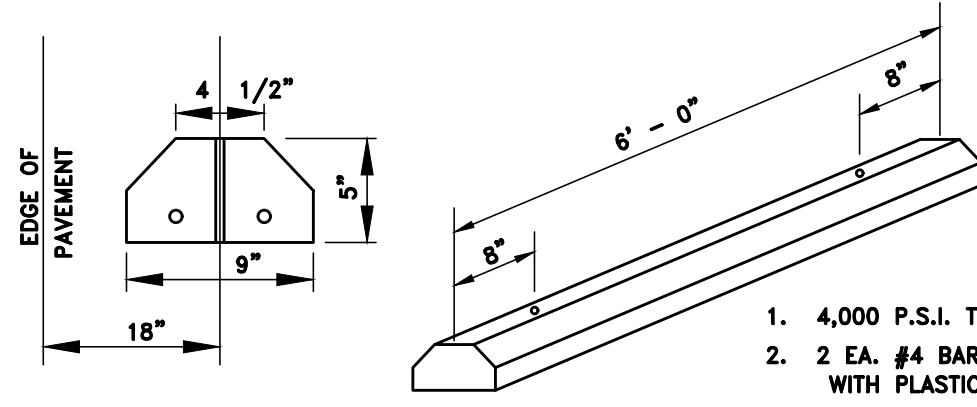

1. 4,000 P.S.I. TYPE II CEMENT
2. 2 EA. #4 BARS ACCURATELY PLACED WITH PLASTIC CHAIRS
3. 2 EA. #6 ANCHOR PINS 16" LONG TO BE FURNISHED AND INSTALLED.

WHEEL STOP DETAIL

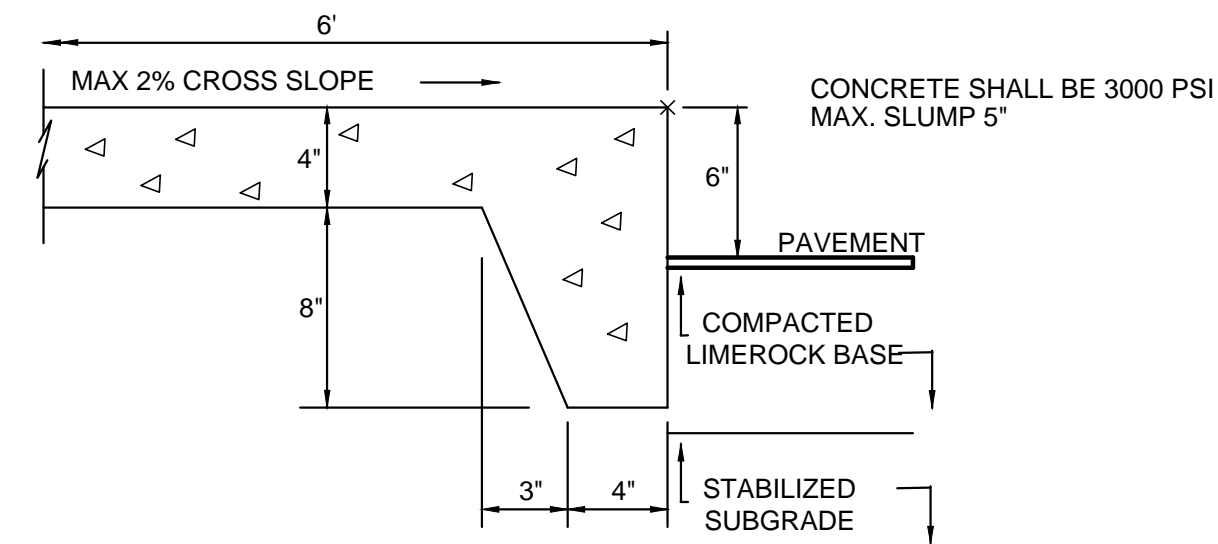

SIDEWALK SECTION WITH TURNDOWN

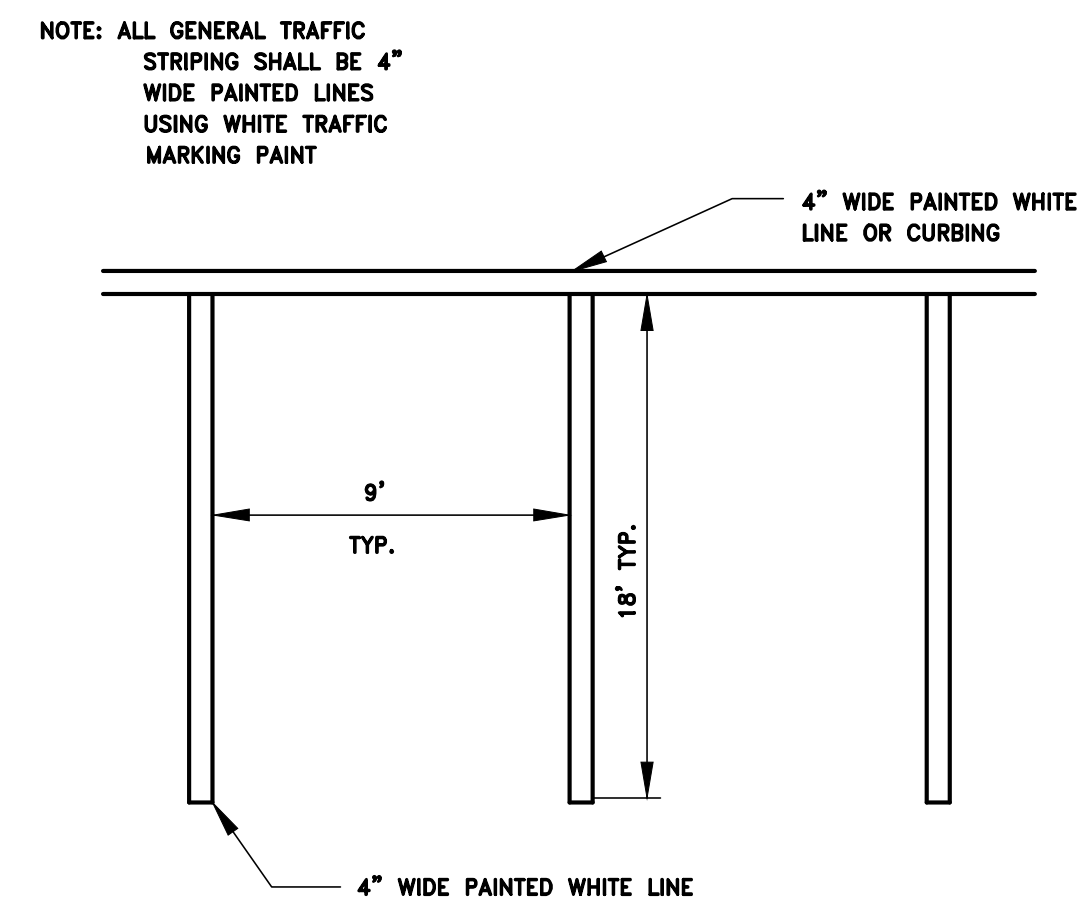

PARKING SPACE LAYOUT

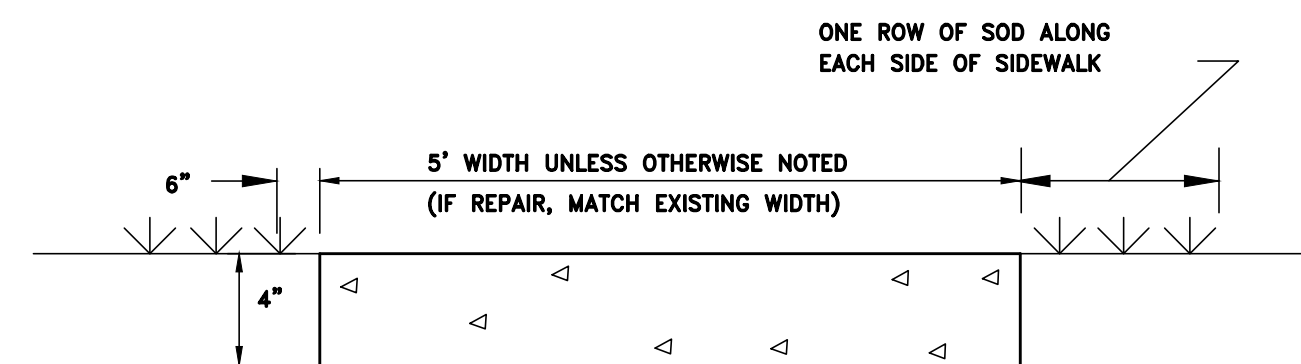

NOTES:
CONCRETE SHALL BE 2,500 PSI, MAX SLUMP 5"
SAWCUT CONTROL JOINTS AT SPACING EQUAL TO WIDTH OF SIDEWALK
INSTALL EXPANSION JOINT AT EVERY FOURTH CONTROL JOINT (25' MAX)
SIDEWALK TO HAVE BROOM FINISH WITH A 4" TROWELED EDGE.

SIDEWALK SECTION

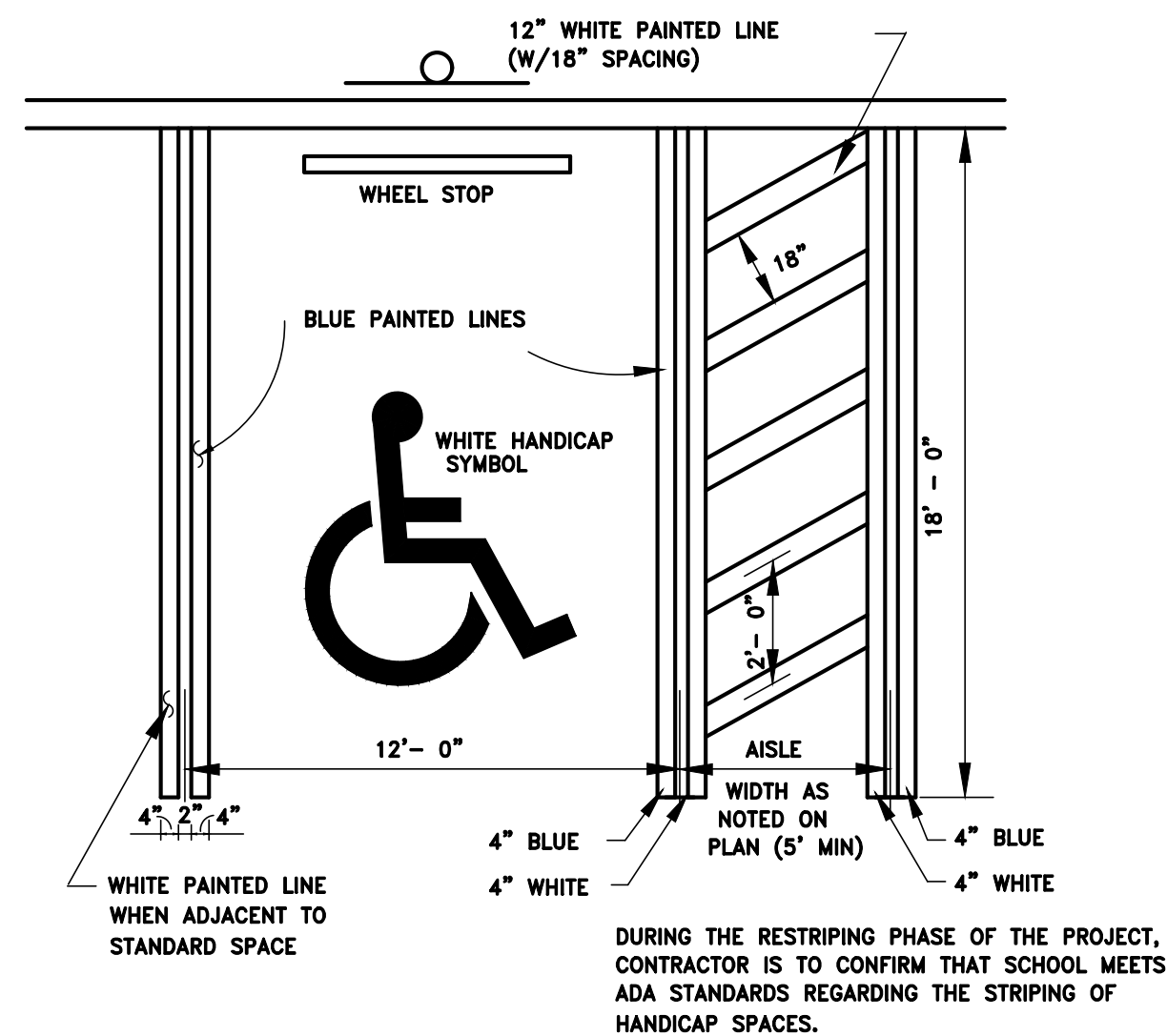

HANDICAP PARKING AND STRIPING

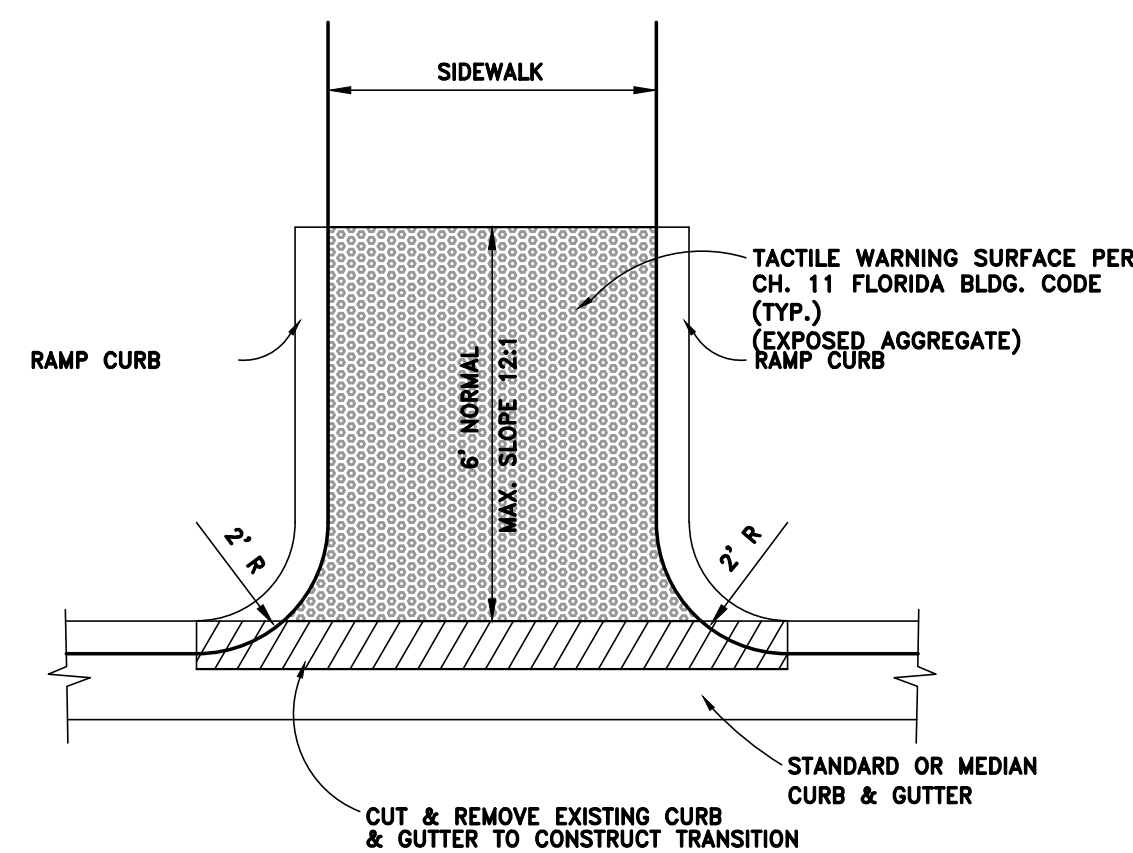

HANDICAPPED RAMP DETAIL

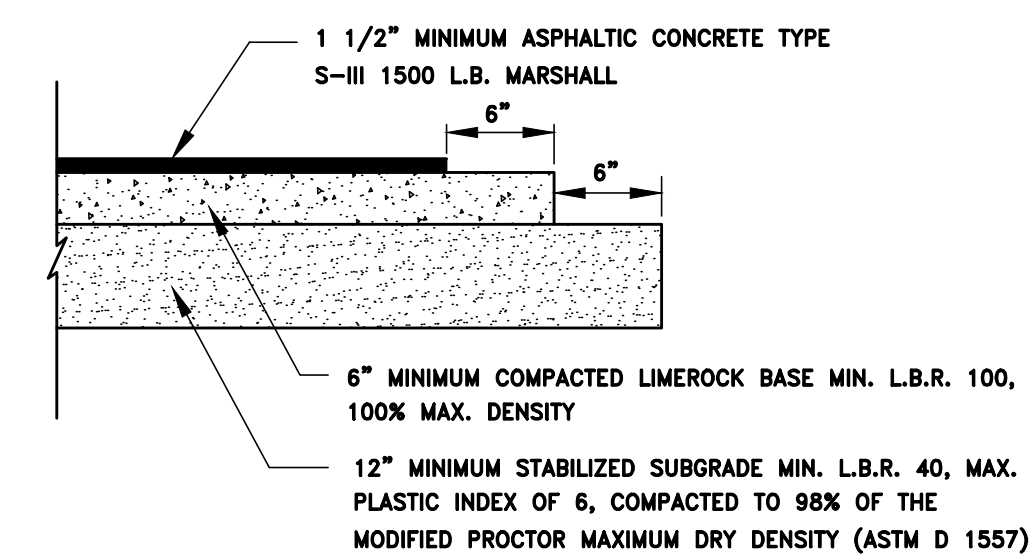

ASPHALT PAVEMENT SECTION-LIGHT DUTY

DATE : MARCH 16, 2016
PROJECT NO. : 98008.18
DESIGNED BY : RPS
DRAWN BY : AEK
SCALE : AS NOTED

No.	Date	Revision
1	01-11-17	ISSUED FOR BID

THIS DRAWING NOT RELEASED FOR CONSTRUCTION UNLESS SO NOTED ABOVE

SHEET TITLE

MISCELLANEOUS NOTES AND DETAILS

C10.0

RYAN P. STILWELL, P.E.
No. 66526
DATE: _____

SHEET



ST. JOHNS COUNTY SCHOOL DISTRICT

Sebastian Administrative Annex

Purchasing Department

3015 Lewis Speedway, Unit 5

St. Augustine, Florida 32084

Telephone (904) 547-8941 FAX (904) 547-8945

Patrick Snodgrass, CPSM

Director of Purchasing

January 31, 2017

TO ALL VENDORS:

The purpose of this letter is to serve as **ADDENDUM #1** to Bid #2017-03 Pavement Rehabilitation.

The following is a list of questions that were asked along with the responses:

1. **Question:** We would like to know how to obtain a pre-qualification package so we can bid your project.

Answer: As stated in the bid, for more information of pre-qualification, contact: Mr. David Lee, Director for Maintenance Services, St. Johns County School District, 299 School House Road, St. Augustine, Florida 32084.

The telephone number for the Maintenance Department is 904-547-3707.

Thank you for your continued participation in the bid process.

Sincerely,

A handwritten signature in black ink that reads 'Patrick Snodgrass'.

Patrick Snodgrass
Director of Purchasing